



Programmable Controller

MELSEC iQ-R series **MELSEC Q** series

C Controller/C Intelligent Function Module
SECS/GEM Communication Software
Pre-installed Model
User's Manual

-Q12DCCPU-V-BZ11
-Q12DCCPU-V-BZ13
-Q12DCCPU-V-BZ15
-RD55UP06-V-BZ11
-RD55UP06-V-BZ13
-RD55UP06-V-BZ15

SAFETY PRECAUTIONS

(Read these precautions before using this product.)

Before using this product, please read this manual and the relevant manuals carefully, and pay full attention to safety to handle the product correctly.

The precautions in this manual concern this product only. Regarding the safety precautions as a programmable controller system, refer to the user manual of the module to be used.

CONDITIONS OF USE FOR THE PRODUCT

(1) Mitsubishi programmable controller ("the PRODUCT") shall be used in conditions;

- i) where any problem, fault or failure occurring in the PRODUCT, if any, shall not lead to any major or serious accident; and
- ii) where the backup and fail-safe function are systematically or automatically provided outside of the PRODUCT for the case of any problem, fault or failure occurring in the PRODUCT.

(2) The PRODUCT has been designed and manufactured for the purpose of being used in general industries.

MITSUBISHI SHALL HAVE NO RESPONSIBILITY OR LIABILITY (INCLUDING, BUT NOT LIMITED TO ANY AND ALL RESPONSIBILITY OR LIABILITY BASED ON CONTRACT, WARRANTY, TORT, PRODUCT LIABILITY) FOR ANY INJURY OR DEATH TO PERSONS OR LOSS OR DAMAGE TO PROPERTY CAUSED BY the PRODUCT THAT ARE OPERATED OR USED IN APPLICATION NOT INTENDED OR EXCLUDED BY INSTRUCTIONS, PRECAUTIONS, OR WARNING CONTAINED IN MITSUBISHI'S USER, INSTRUCTION AND/OR SAFETY MANUALS, TECHNICAL BULLETINS AND GUIDELINES FOR the PRODUCT.

("Prohibited Application")

Prohibited Applications include, but not limited to, the use of the PRODUCT in;

- Nuclear Power Plants and any other power plants operated by Power companies, and/or any other cases in which the public could be affected if any problem or fault occurs in the PRODUCT.
- Railway companies or Public service purposes, and/or any other cases in which establishment of a special quality assurance system is required by the Purchaser or End User.
- Aircraft or Aerospace, Medical applications, Train equipment, transport equipment such as Elevator and Escalator, Incineration and Fuel devices, Vehicles, Manned transportation, Equipment for Recreation and Amusement, and Safety devices, handling of Nuclear or Hazardous Materials or Chemicals, Mining and Drilling, and/or other applications where there is a significant risk of injury to the public or property.

Notwithstanding the above, restrictions Mitsubishi may in its sole discretion, authorize use of the PRODUCT in one or more of the Prohibited Applications, provided that the usage of the PRODUCT is limited only for the specific applications agreed to by Mitsubishi and provided further that no special quality assurance or fail-safe, redundant or other safety features which exceed the general specifications of the PRODUCTS are required. For details, please contact the Mitsubishi representative in your region.

INTRODUCTION

Thank you for purchasing the SECS/GEM communication software.

This manual describes the necessary system configuration, specifications, wiring, and troubleshooting to use the SECS/GEM communication software.

Before using this product, please read this manual and the relevant manuals carefully and develop familiarity with the functions and performance of the SECS/GEM communication software to handle the product correctly.

Please make sure that the end users read this manual.

About this manual

This manual describes the SECS/GEM communication software that has been installed on a C Controller module or C intelligent function module. Before using the SECS/GEM communication software, carefully read the relevant manuals of the C Controller module or C intelligent function module to thoroughly understand the functions and performance of the module.

For details of the SEMI standards, please check the SEMI standards.

CONTENTS

SAFETY PRECAUTIONS	1
CONDITIONS OF USE FOR THE PRODUCT	2
INTRODUCTION	3
RELEVANT MANUALS	9
Terms	9
Scope of operation description	9
CHAPTER 1 SPECIFICATIONS	10
1.1 SEMI standards compliance	10
1.2 GEM standards compliance	11
1.3 Communication Specifications	12
1.4 Message specifications	13
1.5 GEM related specifications	14
CHAPTER 2 PROCEDURE BEFORE OPERATION	15
2.1 Network Setting	16
2.2 SECS/GEM communication settings	17
CHAPTER 3 SYSTEM CONFIGURATION	18
3.1 Overall System Configuration	18
3.2 Software Configuration	20
SECS/GEM Communication Software	20
Configuration tool	20
License	20
3.3 Connected Device Configuration	21
3.4 Operating Environment	21
CHAPTER 4 WIRING	22
CHAPTER 5 INSTALLATION AND UNINSTALLATION	24
5.1 Installation	24
Configuration tool	24
SECS/GEM communication software	26
5.2 License registration	27
5.3 Uninstallation	28
Configuration tool	28
SECS/GEM communication software	28
CHAPTER 6 FUNCTION LIST	29
CHAPTER 7 BASIC FUNCTIONS	36
7.1 Management of projects	36
Conversion	36
Sample transactions	37
7.2 Programmable Controller CPU link function	38
Handshake (for each transaction)	40
Handshake (for each message)	41
None handshake	44

	Periodic message transmission to the host	45
	How to link with devices	45
7.3	Transaction definition	46
	Transaction list display	46
	Display of transaction data	48
	Editing of transaction information definitions	49
	Format specification	51
	Message Information	52
	Item Information	55
	Message structure of the SECS/GEM communication software pre-installed model module	60
7.4	Communication Setting	61
	SECS communication configuration	61
	Communication Setting by PLC	63
7.5	Device Assignment	65
	Shared Memory Setting	65
	I/O assignment	67
7.6	Option Setting	69
	Control 1	69
	Control 2	77
	Retry setting	80
	CA Status	82
	Control Request	85
	SECS Error Notification Setting	90
	S9 Transmission Notification	92
	Console Setting	94
	Version Information	96
7.7	Scenario definition	97
	Scenario Setting	98
7.8	Alarm Definition (non-GEM version)	100
	Alarm List	101
	Alarm Settings	102
	Alarm Notification Setting	103
7.9	Spooling function (non-GEM version)	106
	Spool Definition Settings	106
	Spooled message sending	109
7.10	Project Archive File Get	111
7.11	Updating the SECS/GEM communication software pre-installed model module	112
7.12	IP address setting	114
	Changing the IP address from the setting tool	116
	IP Address Setting by PLC	117
7.13	Data Mapping Settings	119
	Command Setting	120
	Parameter List	120
	Parameter setting	121
	Mapping Setting Example	122
7.14	Conversion Table Setting	124
	Conversion Table Setting	125
	Conversion Data List	126
	Conversion Data Setting	126
	Example of Conversion Table Use	127
	Format conversion definition setting	128

7.15	Device Find/Replace	130
	Display all devices in use	132
	Device Search	132
	Replace Device	133
7.16	Log Output	134
	Log Output Setting	134
	Real Time Trace Setting	141
	Log View	143
	View the Log on Display Device (GOT)	149
	Considerations when the log output function is used	151
7.17	Documentation	153
	SECS Message Definition	154
	Device Assignment Definition	155

CHAPTER 8 GEM Compliant Functions **156**

8.1	GEM PERFORMANCE DEFINITION SETTING	156
8.2	About State Model Management	159
8.3	GEM MODEL STATE NOTIFICATION SETTING	160
8.4	COMMUNICATION STATE MODEL MANAGEMENT	162
	Communication state model setting	164
8.5	CONTROL STATE MODEL MANAGEMENT	166
	Control state model setting	168
8.6	PROCESSING STATE MODEL MANAGEMENT	171
	Process state model setting	172
8.7	Alarm Definition (GEM / GEM advanced version)	174
	Alarm List	174
	Alarm Definition	176
	Common Alarm Settings	177
8.8	Spool Function (GEM / GEM advanced version)	180
	Spool list	180
	Spool Definition	181
	Common Spool Definition settings	182
8.9	PROCESS PROGRAM	185
	Process Program Settings	185
8.10	CLOCK	189
	Clock setting	190
8.11	VARIABLE SETTING	192
	Variable list	192
	Cache settings variables	193
	Variable definition	194
	List setting	197
	Variables defined by default	198
8.12	LIMIT ATTRIBUTE DEFINITION	202
	Limit attribute list	202
	Limit attribute definition	203
8.13	REPORT SETTING	204
	Report list	204
	Report definition	205
	Create Report	205
	Default Definition Reports	206

8.14	EVENT SETTING	207
	Event list	207
	Event definition	208
	Create Event	209
	Events defined by default	210
8.15	DYNAMIC SETTING CHANGE	211
8.16	EQUIPMENT CONSTANT	212
8.17	ADVANCED SETTINGS	214
	Multi-block	214
	Limit monitoring	215
	SECS items	216
	Dynamic setting exclusion	217
	Data acquisition exclusion	218
	DVVAL	219
	Reply Setting	220
8.18	GEM COMPLIANT TABLE	221
CHAPTER 9 SECS/GEM Communication Software Knowledge		222
9.1	Checking that start-up of the SECS/GEM communication software completed	222
9.2	Checking the SECS line state	222
9.3	Checking the registration state of the SECS/GEM communication software license	223
9.4	Sending and receiving messages	224
9.5	Sending alarm messages (S5F1)	227
9.6	Using the spool function	229
9.7	Changing the communication settings from the ladder program	232
9.8	Using the mapping function	233
9.9	Using the conversion table function (table conversion)	237
9.10	Using the conversion table function (format conversion)	238
9.11	Using the conversion table function (index conversion)	239
9.12	Remote command control using the selection list function	240
9.13	Synchronizing the clocks of the equipment and host	243
9.14	Transitioning to a communication state	244
9.15	Transitioning to a control state	245
9.16	Configuring collected events	246
9.17	Using the process program	248
	Usage method	250
CHAPTER 10 TROUBLESHOOTING		253
10.1	Troubleshooting by Symptom	253
APPENDIX		260
Appendix 1 Input/output signals		260
	Initialization setting of host station device	260
Appendix 2 Data type conversion		261
Appendix 3 Reserved Transactions		268
	List of reserved transactions and format	268
	Special Transactions	269
	System Error (S9Fx)	270
Appendix 4 SECS item list		271
Appendix 5 Communication Specifications Check Sheet		273

Appendix 6 SEMI E30(GEM) Support Message	274
Appendix 7 SECS/GEM communication software unique ACK code list	277
Appendix 8 Added and Changed Functions	278
REVISIONS	279
TRADEMARKS	280

RELEVANT MANUALS

Manual name [manual number]	Description	Available form
C Controller/C Intelligent Function Module SECS/GEM Communication Software Pre-installed Model User's Manual [BCN-89999-6494] (this manual)	Explains the specifications, procedure before operation, wiring, functions, and troubleshooting of a C Controller pre-installation module.	PDF
MELSEC iQ-R C Intelligent Function Module User's Manual (Startup) [SH-081566ENG]	Explains the specifications, procedure before operation, wiring, and operation examples of a C intelligent function module.	Print book e-Manual PDF
MELSEC iQ-R C Intelligent Function Module User's Manual (Application) [SH-081567ENG]	Explains the functions, input/output signals, buffer memory, parameter setting, and troubleshooting of a C intelligent function module.	Print book e-Manual PDF
MELSEC-Q C Controller Module User's Manual [SH-081130ENG]	Explains the system configuration, specifications, functions, handling, wiring, troubleshooting, and functions and programming of C Controller modules (Q24DHCCPU-V, Q24DHCCPU-VG, Q24DHCCPU-LS, Q26DHCCPU-LS, Q12DCCPU-V (Extended mode)).	Print book PDF
Setting/Monitoring Tools for the C Controller Module Version 4 Operating Manual [SH-081131ENG]	Explains the system configuration and operation methods of the C Controller setting/monitor tools (SW4PVC-CCPU).	Print book PDF

Terms

Unless otherwise specified, this manual uses the following terms.

Terms	Description
MELSEC iQ-R series SECS/GEM communication software pre-installed model module	Generic name of RD55UP06-V-BZ11, RD55UP06-V-BZ13, and RD55UP06-V-BZ15.
MELSEC-Q series SECS/GEM communication software pre-installed model module	Generic name of Q12DCCPU-V-BZ11, Q12DCCPU-V-BZ13, and Q12DCCPU-V-BZ15.
SECS/GEM communication software	Generic product names of the following software pre-installed on SECS/GEM communication software pre-installed model modules. SW1PVC-Q12V-EBZ11, SW1PVC-Q12V-EBZ13, SW1PVC-Q12V-EBZ15, SW1PVC-RD55-EBZ11, SW1PVC-RD55-EBZ13, SW1PVC-RD55-EBZ15
SECS/GEM communication software pre-installed model module	Generic name of Q12DCCPU-V-BZ11, Q12DCCPU-V-BZ13, Q12DCCPU-V-BZ15, RD55UP06-V-BZ11, RD55UP06-V-BZ13, and RD55UP06-V-BZ15.
Setting tool	Abbreviation of the SECS/GEM communication software setting tool pre-installed on a PC.
Non-GEM version	Generic name of Q12DCCPU-V-BZ11 and RD55UP06-V-BZ11.
GEM version	Generic name of Q12DCCPU-V-BZ13 and RD55UP06-V-BZ13.
GEM advanced version	Generic name of Q12DCCPU-V-BZ15 and RD55UP06-V-BZ15.
DM	Abbreviation of Data Message(Stream Function).
CM	Abbreviation of Command Message(linktest, Connect, etc.).
memory card	Generic name of CF card and SD memory card.

Scope of operation description

Series	SECS/GEM communication software		
	Non-GEM version	GEM version	GEM advanced version
MELSEC-Q series	○	○	○
MELSEC iQ-R series	○	○	○

The table above in this manual indicates the SECS/GEM communication software subject to the operation description.

○: Subject to operation description, —: Not subject to operation description

1 SPECIFICATIONS

This section shows the specifications of the SECS/GEM communication software.

1.1 SEMI standards compliance

The SECS/GEM communication software complies with the following SEMI standards.

○: Compliant △: Partially compliant ×: Not compliant

Standard number	Compliant version	Standard name	SECS/GEM communication software compliance list		
			Q12DCCPU-V-/RD55UP06-V-		
			BZ11 (Non-GEM version)	BZ13 (GEM version)	BZ15 (GEM advanced version)
E4	E4-0699	SEMI Equipment Communications Standard 1 Message Transfer (SECS-I) ^{*1}	△ ^{*2}	△ ^{*2}	△ ^{*2}
E5	E5-1106E	SEMI Equipment Communications Standard 2 Message Content (SECS-II)	○	○	○
E37	E37-0303	High-Speed SECS Message Services (HSMS) Generic Services ^{*3}	○	○	○
E37.1	E37.1-0702	High-Speed SECS Message Services Single Selected-Session Mode (HSMS-SS or HSMS-SSS)			
E37.2	—	High-Speed SECS Message Services General Session (HSMS-GS)			
E30	E30-0307N	Generic Model for Communications and Control of Manufacturing Equipment (GEM)	×	△ ^{*4}	○
E82 ^{*5}	E82-1106	Specifications for Interbay/Intrabay AMHS SEM (IBSEM)			
E88 ^{*5}	E88-0307	Specifications for AMHS Storage SEM (Stocker SEM)			
Draft 6263 ^{*5}	—	PCB equipment communication interface (PCBECI)			

*1 Standards of communication that uses RS-232C.

*2 Supported by Q12DCCPU-V edition only.

*3 Standards of communication that uses TCP/IP.

*4 Basic requirements of GEM are compliant.

*5 Subset of GEM E30.



For the details of specifications and terms of SEMI standards when using the SECS/GEM communication software, check the SEMI standards.

1.2 GEM standards compliance

The SECS/GEM communication software complies with the following GEM standards.

○: Supported ×: Unsupported

Required conditions of GEM standards		SECS/GEM communication software compliance list			
		Q12DCCPU-V-/RD55UP06-V-			
		BZ13 (GEM version)	BZ15 (GEM advanced version)	BZ11 (Non-GEM version)	
Basic Requirements	State model	○	○	×	
	Host-started communication establishment				
	Control state switching				
	Device processing state model				
	Event notification				
	Online check				
	Error message				
	Documentation	×	○	○	
Additional performance	Communication establishment	○	○	×	
	Dynamic event report setting change				
	Variable data acquisition				
	Trace data acquisition	×	○		
	State data acquisition	○	○		
	Alarm management				
	Remote Control				
	Device constant				
	Process recipe management	Process program	×	○	
		E42 recipe	×	×	
		E139 recipe			
	Material transfer	○	○		
	Device terminal service				
	Clock				
	Limit monitoring	×	○		
Spooling	○	○			

1.3 Communication Specifications

This section shows the specifications of SECS communication.

SECS-I(SEMI E4)

Item		Description
Device ID	Number of settings	1
	Value	0 to 32767
Communication port		RS-232C, 1 port
Logical line		Single line (full duplex)
Communication speed		9600 to 115200bps
Number of retries		0 to 31 retries
Master/Slave		Master/Slave
Serial setting	Data length	B8, B7
	Parity	None, even, odd
	Stop bit	S1, S2
	Flow control	None, XON/XOFF, hardware
Timer setting	T1	0.1 to 10s
	T2	0.2 to 25s
	T3	1 to 120s
	T4	1 to 120s

HSMS(SEMI E37)

Item		Description
Device ID	Number of settings	1
	Value	0 to 32767
Communication port		Ethernet, 1 port
Logical line		Single line
Interface		10BASE-T/100BASE-TX
Data transmission rate		10Mbps, 100Mbps
Connection mode		Passive/Active
Timer setting	Link test timer	1 to 65535s
	T3	1 to 120s
	T5	1 to 240s
	T6	1 to 240s
	T7	1 to 240s
	T8	1 to 120s
Line disconnection		Disconnection/connection by trigger relay

1.4 Message specifications

This section shows the specifications of messages.

SECS-II(SEMI E5)

Item		Description
Stream/Function message definition range	Stream	1 to 127
	Function	0 to 255
Transactions with same Stream/Function		Possible (however, must define different transaction name)
Variable length message transmission/reception	Transmission	For L,n, only transmit "n" lists.
	Reception	For L,n, up to "n" lists can be received and the number of lists received ("n") can be output to the control register.
Reconnection Delay After Line Disconnection		1 to 60s
Maximum number of transmission interleave (Number of multi-transaction queues for PLC transmission)		256
Maximum number of queues waiting transmission (Number of transaction queues for PLC transmission)		256
Maximum number of reception interleave (Number of multi-transaction queues for PLC receiving)		256
Other SECS functions*1		Scenario transmission/reception (execute more than one Stream/Function in a row)

*1 Handled by the C Controller module.

1.5 GEM related specifications

This section shows specifications related to GEM.

GEM related performance specifications

Item	Description
Maximum variable setting	65535
Number of Variables that can be linked to 1 list variable	32767, up to 8 layers
Maximum number of limits that can be set for 1 variable	16
Limit monitoring cycle	1000 to 4294967294ms
Variables subjected to limit monitoring	SV with data type other than ASCII/JIS8/BIN
Maximum number of report definitions	512
Number of variables that can be linked to 1 report	256
Maximum number of events that can be defined	512
Maximum number of reports than can be linked to 1 event	64
Traceable variable	SV with data type ASCII/JIS8/BIN supports up to 32 bytes.
Maximum numbers of variables that can be set for 1 Trace ID	256
Number of variables set for 1 Trace ID × Number of Groups	4096 or below
Number of Trace IDs that can be traced simultaneously	16
Maximum number of processing units	99
Maximum SECS message length	5M Bytes (5242880 Bytes)
Maximum ASCII data length	256 Bytes
Number of dynamic messages that can be simultaneously created	128
Number of Cache area that can be set	32
Maximum communication establishment timeout	240s
Maximum number of alarms that can be set	4096

2 PROCEDURE BEFORE OPERATION

The following section shows the procedure until operation.

1. Mounting modules on a base unit

Install the programmable Controller CPU and SECS/GEM communication software pre-installed model module on the base module.

For the installation on the base module, see the following reference.

Module to be used	Reference
C intelligent function module	MELSEC iQ-R Module Configuration Manual
C Controller module	C Controller Module User's Manual (Hardware Design, Function Explanation)

2. Wiring of equipment

Connect the SECS/GEM communication software pre-installed model module, personal computer, and other network equipment.

3. Installation of setting tools

Install the setting tools on the PC.

For the installation method, see the following reference.

Page 24 Configuration tool

Point

When the SECS/GEM communication software pre-installed model module has been initialized, install the SECS/GEM communication software, and then activate the license again.

For the method to install the SECS/GEM communication software, see the following reference.

Page 112 Updating the SECS/GEM communication software pre-installed model module

For the license registration method, see the following reference.

Page 27 License registration

4. Setting parameters

Configure the parameters of the programmable controller CPU and the SECS/GEM communication software pre-installed model module.

For the setting method of the parameters, see the following reference.

Module to be used	Reference
C intelligent function module	MELSEC iQ-R C Intelligent Function Module User's Manual (Startup)
C Controller module	Setting/Monitoring Tools for the C Controller Module Version 4 Operating Manual

5. Network settings

Configure the network parameters.

For the configuration method, see the following reference.

Page 16 Network Setting

6. SECS/GEM communication settings

Use the setting tool to configure the transaction information, communication settings, device assignment settings, etc.

For the configuration procedure, see the following reference.

Page 17 SECS/GEM communication settings

7. Setting update

Update the setting file stored on the SECS/GEM communication software pre-installed model module.

For the update procedure, see the following reference.

Page 112 Updating the SECS/GEM communication software pre-installed model module

2.1 Network Setting

This section explains the network configuration.

Devices	Setting method
SECS/GEM communication software pre-installed model module	Configure the parameters using GX Works3 or the Setting/monitoring tools for the C Controller module.
Host	Configure the PC network.
Computer for configuration	Configure the PC network.

Network setting for connection

Operating procedure

1. Configure the network section of each device in the same manner.

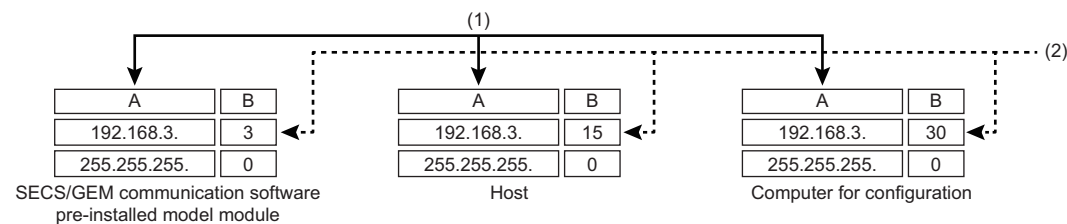

A: Network section

B: Host section

(1) Configure the same value.

(2) Configure different values.

2. Configure the network settings of the personal computer using the "Internet Protocol Version 4 (TCP/IPv4) Properties" screen.

(Example) Windows 7

① Select [Control Panel] ⇒ [Network and Internet] ⇒ [Network and Sharing Center] ⇒ [Change adapter settings].

② Select "Local Area Connection" and select [Properties] on the shortcut menu.

③ At the "Local Area Connection Properties" screen, choose "Internet Protocol Version 4 (TCP/IPv4)", and then click the [Properties] button.

④ The "Internet Protocol Version 4 (TCP/IPv4) Properties" screen appears.

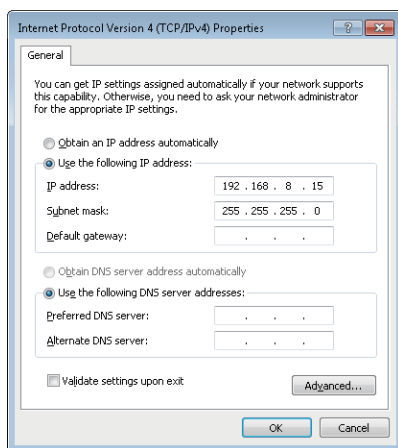

2.2 SECS/GEM communication settings

This section shows the procedure to use the setting tools to configure SECS/GEM communication.

1. Setting transaction information

Configure the transaction name, and then select the handshake method.

For the configuration procedure, see the following reference.

 Page 46 Transaction definition

2. Setting message information

Configure items such as Stream Function, response monitoring setting, and triggers to report sending/reception.

For the configuration procedure, see the following reference.

 Page 52 Message Information

3. Setting Item information

Configure items such as the data type, data quantity, and control register to acquire or register data.

For the configuration procedure, see the following reference.

 Page 55 Item Information

4. Communication setting

Select the SECS communication method.

When HSMS is selected, configure items such as the connection mode, IP address, and timer values.

When SECS-I is selected, configure items such as the RS-232C communication port setting and timer values.

For the configuration procedure, see the following reference.

 Page 61 Communication Setting

5. Device assign

Register the device to be used for control of triggers, registers, etc.

For the configuration procedure, see the following reference.

 Page 65 Device Assignment

6. Other settings

Configure the settings to use the alarms, spools, and other functions arbitrarily.

Point

Always save the project after configuring each type of data and before updating the SECS/GEM communication software pre-installed model module.

3 SYSTEM CONFIGURATION

This section explains the configuration of the system upon which the SECS/GEM communication software runs. Use the SECS/GEM communication software pre-installed model module together with the programmable controller CPU. For the system configuration of the MELSEC iQ-R series and the programmable controller CPUs that can use the C intelligent function module, see the following reference.

📖 MELSEC iQ-R Module Configuration Manual

For the system configuration of the MELSEC-Q series and the programmable controller CPUs that can use the C Controller module, see the following reference.

📖 MELSEC-Q C Controller Module User's Manual

3.1 Overall System Configuration

This section shows the overall system configuration when the SECS/GEM communication software pre-installed model module is used.

MELSEC iQ-R series SECS/GEM communication software pre-installed model module

This section shows a system configuration example when the MELSEC iQ-R series SECS/GEM communication software pre-installed model module is used.

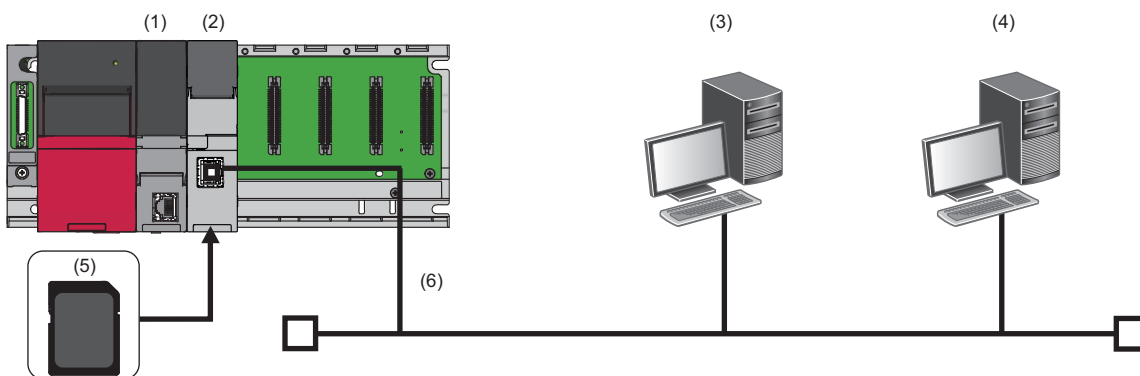

- (1) Programmable controller CPU
- (2) MELSEC iQ-R series SECS/GEM communication software pre-installed model module
- (3) Host
- (4) Computer for configuration
- (5) SD memory card
- (6) Ethernet cable

MELSEC-Q series SECS/GEM communication software pre-installed model module

This section shows a system configuration example when the MELSEC-Q series SECS/GEM communication software pre-installed model module is used.

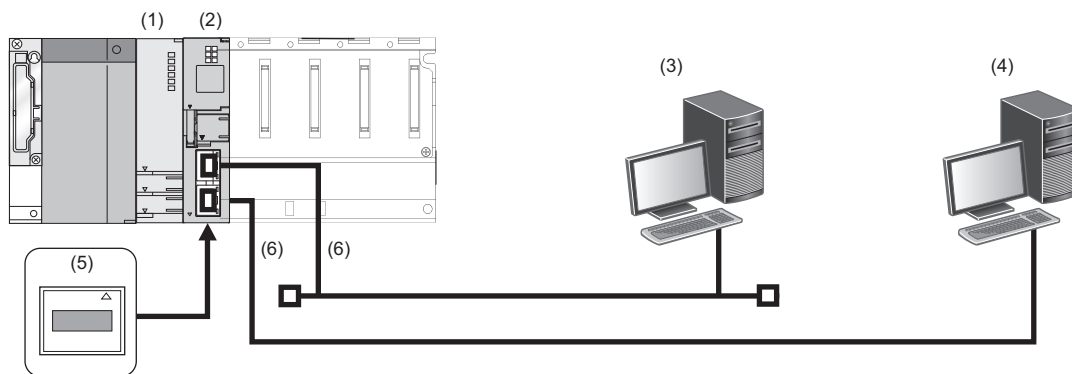

- (1) Programmable controller CPU
- (2) MELSEC-Q series SECS/GEM communication software pre-installed model module
- (3) Host
- (4) Computer for configuration
- (5) CF card
- (6) Ethernet cable

3.2 Software Configuration

This section shows the configuration of the SECS/GEM communication software.

SECS/GEM Communication Software

Software to perform SECS/GEM communication.

The software is preinstalled on the SECS/GEM communication software pre-installed model module before product shipping.

Configuration tool

Tool to configure the interface of SECS/GEM communication.

License

A license file is necessary to use the SECS/GEM communication software.

The license file is activated on the SECS/GEM communication software pre-installed model module before product shipping.

If the license file has been lost because of initialization of the SECS/GEM communication software pre-installed model module, activate the license again.

For the license registration method, see the following reference.

 Page 27 License registration

Precautions

- One license file is assigned to one SECS/GEM communication software pre-installed model module.
- The product CD-ROM of the SECS/GEM communication software is required to recover the license file. Store the product CD-ROM carefully so that it is not lost.

3.3 Connected Device Configuration

This section shows equipment that can be connected to the SECS/GEM communication software pre-installed model module.

SD memory card (need to purchase separately)

For SD memory cards that can be used with the MELSEC iQ-R series SECS/GEM communication software pre-installed model module, see the following reference.

📖 MELSEC iQ-R C Intelligent Function Module User's Manual (Startup)

CF card (sold separately)

For CF cards that can be used with the MELSEC-Q series SECS/GEM communication software pre-installed model module, see the following reference.

📖 MELSEC-Q C Controller Module User's Manual

Precautions

Always install a memory card when using the SECS/GEM communication software.

Because the number of writes to a memory card is limited, determine the necessity of writing functions, such as link test logs and programmable-controller detailed log collection, before using a card.

Before removing a memory card, make sure that there is no file access. If the card is removed during data writing, internal files may become corrupted.

3.4 Operating Environment

This section shows the operating environment for configuration tool.

Item	Description
Personal computer	— A personal computer on which Microsoft Windows operates
Free space of installation drive	During installation: free storage space of 20 MB or more
OS (English language version)	Windows 10 Windows 7 (Service Pack 1 or later) Windows XP (Service Pack 3 or later) Windows 2000 (Service Pack 4 or later)
Necessary software	Internet Explorer (6.0 or later)

4 WIRING

This section explains the wiring of a SECS/GEM communication software pre-installed model module.

Ethernet cable

For Ethernet, a cable that complies with the IEEE802.3 100BASE-TX/10BASE-T standards can be used.

For the specifications of cables that can be used, see the following reference.

 MELSEC iQ-R C Intelligent Function Module User's Manual (Startup)

 MELSEC-Q C Controller Module User's Manual

RS-232 cable

For the specifications of RS-232 cables that can be used, see the following reference.

 MELSEC-Q C Controller Module User's Manual

MEMO

5 INSTALLATION AND UNINSTALLATION

This section explains installation and uninstallation.

5.1 Installation

This section explains the installation of setting tools and the SECS/GEM communication software.

Configuration tool

Preparation for installation

Confirm the following before installing the setting tools.

- Before installing the setting tools, log in as an Administrator user.
- Do not run multiple installers at the same time. If multiple installers were run at the same time, installation may not be completed normally. If installation of the tools was not completed normally, uninstall the tools, and then install them again.
- If the confirmation screen for User Account Control appears during installation of the setting tools, click the "Allow" or "Yes" button to proceed with the installation.

Installation of tools

The following procedure is an example of installing the setting tool for Q12DCCPU-V-BZ15 on a PC running Windows 7.

1. Insert the product CD-ROM into the PC.

The setup wizard starts.

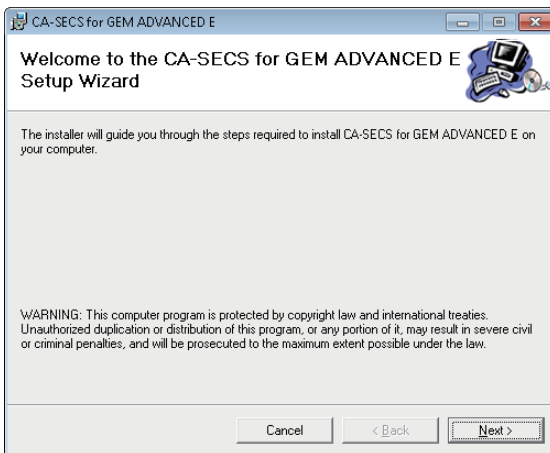

If the setup wizard does not start, double-click 'setup.exe' in the "CA-SECS for GEM ADVANCED"*1 folder on the product CD-ROM.

*1 The folder name of the product CD-ROM differs for each product.

2. Click the [Next] button.

3. Check the installation folder setting, and then click the [Next] button.

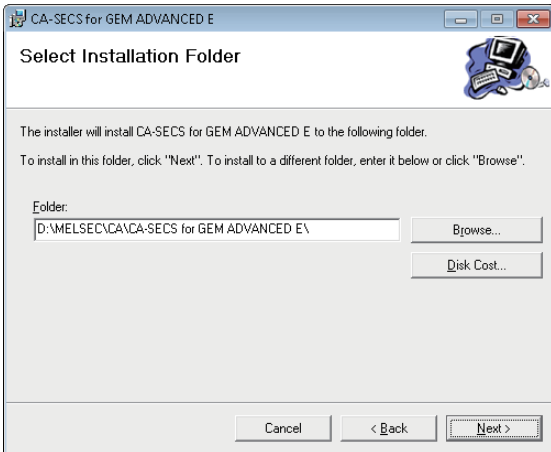

4. Click the [Next] button.

Installation of the setting tool starts.

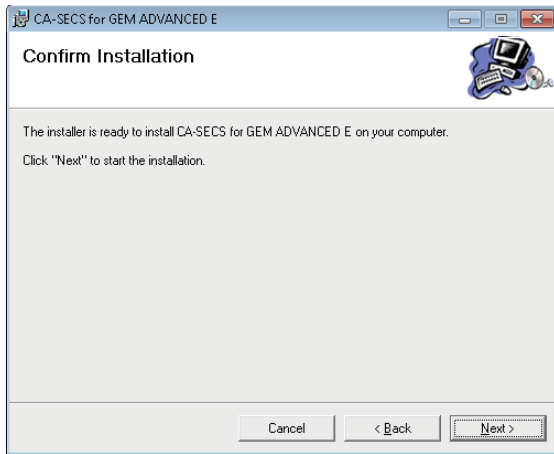

If installation of the setting tools is completed normally, the following screen appears.

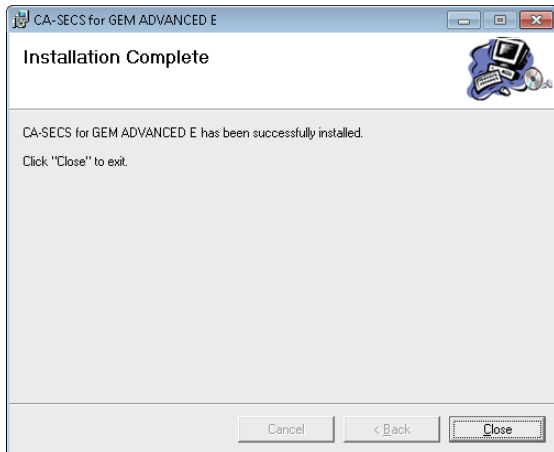

Environment after installation

This section describes the environment after installation of the setting tools.

■ Menus to be registered

The menus of the installed setting tools are registered to the Start Menu of Windows®.

Menu name		Description	
MELSEC	CA*1	CA-SECS E	Starts the setting tool for Q12DCCPU-V-BZ11.
		CA-SECS for GEM E	Starts the setting tool for Q12DCCPU-V-BZ13.
		CA-SECS for GEM ADVANCED E	Starts the setting tool for Q12DCCPU-V-BZ15.
		CA-SECS RD55 E	Starts the setting tool for RD55UP06-V-BZ11.
		CA-SECS for GEM RD55 E	Starts the setting tool for RD55UP06-V-BZ13.
		CA-SECS for GEM ADVANCED RD55 E	Starts the setting tool for RD55UP06-V-BZ15.

*1 Does not appear in Windows® 8 or later.

SECS/GEM communication software

For the method to install the SECS/GEM communication software, see the following reference.

☞ Page 112 Updating the SECS/GEM communication software pre-installed model module

5.2 License registration

The license of the SECS/GEM communication software has been activated on the SECS/GEM communication software pre-installed model module in advance.

If the SECS/GEM communication software pre-installed model module has been initialized, the license is deleted.

In such a case, you must use the license file stored on the product CD-ROM to register the license again.

The following shows the procedure for registering the license again:

1. Copy the license file^{*1} from the product CD-ROM to a personal computer.
2. Select [Help]⇒[License registration]
3. Select the license file copied from the product CD-ROM.

The "Update Module" screen appears.

4. Set each item.

*1 The license file is stored in the following folder on the product CD-ROM:

\\Backup\LF****.DAT

The license file name is 'LF****.DAT' and '****' contains 16 alphanumeric characters.

Point

The activation destination of the license is the transfer destination (ROM or memory card) selected at the "Update Module" screen or "Update C intelligent module" screen.

5

Precautions

- Do not specify the license file of the product CD-ROM directly.

Checking a license

Whether a genuine license is registered can be checked by either of the following methods:

Module	Checking method
MELSEC iQ-R series SECS/GEM communication software pre-installed model module	Check it in the event history of the control CPU.
MELSEC-Q series SECS/GEM communication software pre-installed model module	Check it in the event history of Setting/monitoring tools for the C Controller module.

Registering a license again

Before registering a license again, check the following settings:

- In the case of an MELSEC iQ-R series SECS/GEM communication software pre-installed model module, have the settings that enable Ethernet communication been configured by GX Works3?
- In the case of a MELSEC-Q series SECS/GEM communication software pre-installed model module, has Channel 1 of the Ethernet port been enabled by the Setting/monitoring tools for the C Controller module?

5.3 Uninstallation

This section explains the uninstallation method for setting tools and the SECS/GEM communication software.

Configuration tool

This section explains the method to uninstall the settings tool from the PC.

The settings tool is uninstalled from the Control Panel of Windows.

Environment after uninstallation

During uninstallation, registered menus and files are deleted.

 Page 26 Environment after installation

SECS/GEM communication software

If the SECS/GEM communication software pre-installed model module is initialized, the SECS/GEM communication software is deleted.

For the method to initialize the SECS/GEM communication software pre-installed model module, see the following reference.

 MELSEC iQ-R C Intelligent Function Module User's Manual (Application)

 MELSEC-Q C Controller Module User's Manual

6 FUNCTION LIST

This section explains the functions of the SECS/GEM communication software and setting tools.

SECS communication

○: Supported —: Unsupported

Function		Overview	Q12DCCPU-V-			RD55UP06-V-		
			BZ11	BZ13	BZ15	BZ11	BZ13	BZ15
SECS-I communication function		Use a [SEMI E4 compliant] RS-232C port to correspond with the host.	○	○	○	—	—	—
HSMS communication function		Use a [SEMI E37 compliant] Ethernet port to correspond with the host.	○	○	○	○	○	○
Device ID specify function		Specify an arbitrary device ID.						
SECS-II	StreamFunction definition (SF definition)	Define SF arbitrarily within the scope of the SECS standards and user definitions.						
	same SF definition	Define the same SF.						
	Abort Frame Sending	Send an abort frame.						
	Abort Frame Reception	Receive an abort frame.						
	Variable length frame transmission	Send a message containing a variable length item.						
	Variable length frame reception	Receive a message containing a variable length item.						
Others	Scenario transmission/reception	Link and process arbitrary transactions.	○	○	○	—	—	—
	Reconnect upon line disconnection	Contact the host again after line recovery.	○	○	○	○	○	○
	Single transaction control	Do not process another transaction until the transaction is complete.						
	Multi-transaction control	Process multiple transactions simultaneously.						
	Sending waiting queue	Queue messages waiting to be sent.						

Basic Requirements of GEM

○: Supported —: Unsupported

Function		Overview	Q12DCCPU-V-			RD55UP06-V-		
			BZ11	BZ13	BZ15	BZ11	BZ13	BZ15
[State model] compliance	Communication state	Manage the communication state automatically.	—	○	○	—	○	○
	Control state	Manage the control state automatically.						
	Processing state	Manage the processing state automatically.						
	Spooling state	Manage the spooling state automatically.						
[Device process state] compliant		During transition of the processing state, report the event to the host automatically.						
[S1F13/F14 scenario started by host] compliant		Deals with communication establishment from the host						
[Event notification] compliant		Report the equipment event to the host automatically/manually.						
[Online check] compliant		Respond to an online check from the host automatically.						
[Error messages] compliant		Send errors detected by the equipment to the host by an S9 message	○	○	○	○	○	○

Function		Overview	Q12DCCPU-V-			RD55UP06-V-		
			BZ11	BZ13	BZ15	BZ11	BZ13	BZ15
[Control (started by operator)] compliant	Controlling the communication state from the equipment	Control the communication state from the equipment.	—	○	○	—	○	○
	Controlling the control state from the equipment	Control the control state from the equipment.						
[Documentation] compliant		Output documents required by GEM.	—	—	○	—	—	○

Additional GEM performance

○: Supported —: Unsupported

Function		Overview	Q12DCCPU-V-			RD55UP06-V-		
			BZ11	BZ13	BZ15	BZ11	BZ13	BZ15
[Communication establishment] compliant		Establish communication with a host that complies with GEM.	—	○	○	—	○	○
[Dynamic event report setting change] compliant		Enable the change of event reports settings dynamically from the host.						
[Variable data collection] compliant		Notify the host by report of the equipment variables requested from the host.						
[Trace data collection] compliant	Sampling	Sample equipment variables periodically by an instruction from the host.	—	—	○	—	—	○
	Trace data sending	Send the sampling result to the host as trace data.						
[State data collection] compliant		Report data related to state variables requested from the host to the host.	—	○	○	—	○	○
[Alarm management] compliant	Report to host	Report equipment alarms to the host.	○	○	○	○	○	○
	Change from host	Enable the change of alarm settings dynamically from the host.	—	○	○	—	○	○
[Remote control] compliant		Deal with commands received from the host	○	○	○	○	○	○
[Equipment constant] compliant	Configuration of equipment constants	Configure the equipment constants by the setting tools.	—	○	○	—	○	○
	Change from host	Change the equipment constants from the host.						
	Report to host	Report equipment constants requested from the host to the host.						
[Process Recipe Management] compliant	Formatted process programs	Register formatted process program from the host to the device.	—	—	○	—	—	○
	Equipment process program directory information	Send directory information of the process programs of the equipment by a request from the host.						
	Equipment-side process program update	Notify the host of the update state of process programs at the equipment.						
	Deletion of equipment-side process programs	Delete equipment-side process programs at the request of the host.						
[Material transfer] compliant		Send a [Port transfer event] to the host by an instruction from the programmable controller CPU.	—	○	○	—	○	○
[Device terminal service] compliant	Terminal display data registration	Register terminal display data from the host to the device.	○	○	○	○	○	○
	Terminal request sending	Send a text message to the host.						
[Clock] compliant	Synchronizing the time of the module with the host time	Set the time of the module to the time data reported from the host.						
	Registration of host time to device	Register the time data reported from the host to the device.						
	Time inquiry from the host	Return time data that complies with the time inquiry from the host.						

Function		Overview	Q12DCCPU-V-			RD55UP06-V-		
			BZ11	BZ13	BZ15	BZ11	BZ13	BZ15
[Limit monitoring] compliant	Monitoring of upper and lower limits of variables	Monitor the transfer of the upper and lower limits of variables.	—	—	○	—	—	○
	Event notification	Send an event to the host when a transition occurs.						
[Spooling] compliant	Spooling target specification	Specify messages subject to spooling.	○	○	○	○	○	○
	Spooling	Spool messages subject to spooling to the memory card.						
	Automatic spooling	Spool messages subject to spooling to a memory card automatically during a communication disconnection.						
	Spooled data sending	Send spool data to the host by an instruction from the host.						
	Spool data deletion	Delete spool data by an instruction from the host.						
[Control (started by host)] compliant		Deal with instructions of online/offline switching from the host.	—	○	○	—	○	○

Programmable controller interface

○: Supported —: Unsupported

Function		Overview	Q12DCCPU-V-			RD55UP06-V-		
			BZ11	BZ13	BZ15	BZ11	BZ13	BZ15
Trigger handshake	Handshake (for each transaction)	Use a trigger handshake for handshakes (for each transaction).	○	○	○	○	○	○
	Handshake (for each message)	Use a trigger handshake for handshakes (for each message).						
	No handshakes	Do not use trigger handshakes.						
Data Type Conversion	SECS message (ASCII) → internal data	Convert from ASCII to an arbitrary data format when storing data received by an SECS message to the device.						
	Internal data → SECS message (ASCII)	Convert an arbitrary data format to ASCII when creating an SECS message from device values.						
Shared memory synchronization		Adjust the checking interval of the multiple CPU auto refresh area.	○	○	○	—	—	—

Function		Overview	Q12DCCPU-V-			RD55UP06-V-		
			BZ11	BZ13	BZ15	BZ11	BZ13	BZ15
Status notification	Control Ready status	Reports that the SECS/GEM communication software that started is in a controllable state.	○	○	○	○	○	○
	Control error status	Checks the operation state of the SECS/GEM communication software.						
	Online status	Reports that an online state was established with the host (S1F1→S1F2).						
	Line disconnecting status	Reports that the line with the host was disconnected.						
	Establishing communication status	Reports that communication was established with the host.						
	Queue full of messages waiting to be sent	Reports that the count of the sending message queue from the SECS/GEM communication software became full.						
	Spooling state	Reports that messages subject to spooling are being spooled.						
	Spoiled message sending	Reports that the SECS/GEM communication software is sending messages subject to spooling.						
	Memory card error	Reports that some kind of error was detected in the memory card.						
	Battery error	Reports that the built-in battery has been depleted.	○	○	○	—	—	—
	FTP server log output error	Reports that the log output to the FTP server failed.	○	○	○	○	○	○

Function		Overview	Q12DCCPU-V-			RD55UP06-V-		
			BZ11	BZ13	BZ15	BZ11	BZ13	BZ15
SECS communication error notification	Abort Frame Reception	Reports that an abort message was received from the host.	○	○	○	○	○	○
	Abort Frame Sending	Reports that an abort message was sent from SECS/GEM communication software.						
	Sending failure	Reports that data sending to the host failed.						
	T1 timeout occurred	Reports that a timeout occurred between characters during reception from the host.	○	○	○	—	—	—
	T2 timeout occurred	Reports that a protocol timeout occurred with the host.						
	T3 timeout occurred	Reports that a response timeout occurred with the host.	○	○	○	○	○	○
	T4 timeout occurred	Reports that a timeout occurred between message blocks during reception from the host.	○	○	○	—	—	—
	T9 timeout occurred	Reports that a T9 timer management timeout occurred.	○	○	○	○	○	○
	Scenario Interruption	Reports that the scenario execution was interrupted for some reason.	○	○	○	—	—	—
	Handshake failure	Reports that a handshake link with the programmable controller CPU failed during data reception.	○	○	○	○	○	○
	Communication error	Reporting the Stream Function number generated by a transmission error. Reporting the trigger relay generated by a transmission error.						
	System error (S9) message sending	Reports that a system error (S9) message was sent.						
	Control Request	Line Connection	Specify port open in the case of SECS-I communication. Specify Connect or Select in the case of HSMS.					
Line Disconnection		Specify port close in the case of SECS-I communication. Specify Disconnect in the case of HSMS.						
Offline		Specify a transfer to offline state.						
Online Start		Start in an online state.	○	—	—	○	—	—
Abort Frame Sending		Specifies sending of an abort frame for the received primary message.	○	○	○	○	○	○
S9F7 sending		Specify S9F7 sending.						
Spool function ON/OFF switching		Switches the spooling function on and off by a relay.	○	—	—	○	—	—
Spooled message sending		Specifies sending of spool messages.						
Spooled message discarding		Specifies discarding of spool messages.						
Scenario Interruption		Specifies interruption of the scenario.	○	○	○	—	—	—
Log output start/end	Specifies the start/end of output of SECS transmission logs, programmable controller CPU logs, and user logs.	○	○	○	○	○	○	

Basic Functions

○: Supported —: Unsupported

Function		Overview	Q12DCCPU-V-			RD55UP06-V-		
			BZ11	BZ13	BZ15	BZ11	BZ13	BZ15
Transaction	Transaction list display	Display defined transactions as a list.	○	○	○	○	○	○
	Defining the transaction property	Define the names of transactions.						
	Cache settings	Define the cache of the device to be used by the transaction.						
	Message Information	Define the message information of transactions.						
	Defining the item property	Define the item properties of messages.						
	Fixed-length ASCII item correction function	During fixed-length ASCII item data sending, correct so that the data length is fixed length.						
Monitoring timer	PLC Response Monitoring Timer	Monitors and detects non-response of the programmable controller CPU by the PLC Response Monitoring Timer.						
	Secondary Monitoring Timer	Monitor and detect secondary sending-back non-requests by the Secondary Monitoring Timer.						
	Transaction response monitoring timer	Monitor and detect the transaction execution interval by the transaction response monitoring timer.	○	○	○	—	—	—
Data processing	Table Convert Setting		○	○	○	○	○	○
	Transmission data mapping processing settings							

Logs

○: Supported —: Unsupported

Function		Overview	Q12DCCPU-V-			RD55UP06-V-		
			BZ11	BZ13	BZ15	BZ11	BZ13	BZ15
Logging	SECS transmission log	Summary display, list structure display, detailed display Transmission data file saving (number of retention days specification, one-hour units)	○	○	○	○	○	○
	Link Test Log	Link Test log output selection is possible.						
	Programmable controller log	Select all SECS/GEM Communication Software link I/Os or only trigger relays, and then output.						
	User Log	Output logs of character string data stored in a designated register.						
	Real time trace	Output SECS data and device I/O information to registers.						
Save Destination	Memory card	Output logs to a memory card.						
	FTP server	Output logs to the FTP server.						
Logging output to device (display log on display device)		Display SECS transmission logs, programmable controller CPU logs, and user logs on a display device via registers.						
Log trigger start/end		Available (SECS communication log output, programmable controller log output, and user log output relay trigger specifications)						
Log data acquisition method		FTP/RS-232C ^{*1}						
Log View		Displays acquired logs.						

*1 Supported for only the MELSEC-Q series SECS/GEM communication software pre-installed model module.

Others

○: Supported —: Unsupported

Function		Overview	Q12DCCPU-V-			RD55UP06-V-		
			BZ11	BZ13	BZ15	BZ11	BZ13	BZ15
Conversion		Supplements the differences of project file structures due to product version upgrades.	○	○	○	○	○	○
Definition content network download function		Transfer the setting content to the SECS/GEM communication software pre-installed model module.						
User definition archive function		Archive the setting file, and then save it to the SECS/GEM communication software pre-installed model module.						
Automatic restart after update function		Re-import an updated settings file by restarting the control software, but not stopping the equipment.						
Definition information documentation output		Output the SECS message definitions and device assignment definitions as a .csv file.	○	—	○	○	○	○
IP address setting function	Configuration from setting tools	Configure the IP address of the SECS/GEM communication software pre-installed model module from the setting tool.	○	○	○	○	○	○
	Configuring via registers	Configure the IP address of the SECS/GEM communication software pre-installed model module via registers.						
Device Find/Replace	Device search	Search for devices in use.						
	Replace Device	Replace devices in use.						

7 BASIC FUNCTIONS

7.1 Management of projects

Series	SECS/GEM communication software		
	Non-GEM version	GEM version	GEM advanced version
MELSEC-Q series	<input type="radio"/>	<input type="radio"/>	<input type="radio"/>
MELSEC iQ-R series	<input type="radio"/>	<input type="radio"/>	<input type="radio"/>

Projects of the SECS/GEM communication software are managed by .xml files that define transactions and other environment setting files.

There are two methods to create a new project: open an existing transaction and then arrange it following company use or create a new transaction.

This section explains how to manipulate projects, such as creating new projects, opening projects and saving projects.

Creating a new project

Create a project.

In the transaction list of the newly created project, there is blank data by the name "New transaction".

 [File]⇒[New Create]

Opening a project

Import a saved project.

 [File]⇒[Open]

Save / Save as New

Save an edited project.

 [File]⇒[Overwrite Save] or [Save As]

Conversion

Convert a project created by a previous version of the setting tool so that it can be opened by the setting tool currently in use.

Window

 [File]⇒[Convert]

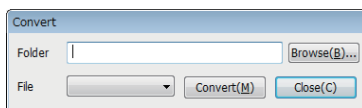

Displayed items

Item	Description
Folder	Select the folder that is storing the setting file.
File	Select the transaction setting file for conversion.
[Convert] button	Convert the type of file in the selected folder.

Sample transactions

A sample that collects generally used transactions is saved in the following folder during installation.

You can use the sample as well when learning the usage of the SECS/GEM communication software.

Sample transactions: (SECS/GEM communication software installation folder)/SAMPLE/SAMPLE.XML

7.2 Programmable Controller CPU link function

Series	SECS/GEM communication software		
	Non-GEM version	GEM version	GEM advanced version
MELSEC-Q series	○	○	○
MELSEC iQ-R series	○	○	○

A relay must be linked between the programmable controller CPU and the SECS/GEM communication software when messages are transmitted.

There are three methods to link the relay.

- Handshake (for each transaction)
- Handshake (for each message)
- None handshake

The following table shows the features of each method.

Type	Handshake (for each transaction)	Handshake (for each message)	None handshake
Relay	<ul style="list-style-type: none"> • A same relay is used for both reception and transmission. • Number of relays used = Number of transactions 	<ul style="list-style-type: none"> • Different relays are used for reception and transmission. • Number of relays used = Number of transactions × 2 	
Operation of relay	<p>Primary message reception → secondary message sending: SECS/GEM communication software turns the relay ON during a reception notification, and then programmable controller turns the relay OFF during a sending request.</p> <p>Primary message sending → secondary message reception: The programmable controller turns the relay ON during a sending request, and then SECS/GEM communication software turns the relay OFF during a reception notification.</p>	<p>Reception: The SECS/GEM communication software turns the relay ON, and then sends notification, and then the programmable controller turns the relay OFF.</p> <p>Transmission: The Programmable Controller CPU turns the relay ON to request the transmission and then SECS/GEM communication software turns the relay OFF.</p>	<p>Reception: The SECS/GEM communication software turns the relay ON, and then turns it OFF after keeping the trigger for a predetermined time.</p> <p>Transmission: The programmable controller CPU turns the relay ON, and then turns it OFF after holding the trigger for a predetermined time.</p>
Ladder programming	Processing is necessary to switch the trigger detection method ON or OFF depending on the distinction of the operations above.	A same trigger detection mechanism should be used.	A same trigger detection mechanism should be used, but the system should be programmed to turn the transmission request relay OFF after a fixed monitoring time and to prevent double detection after the receive notification detection.
Link with programmable controller CPU	Detectable for each transaction	Detectable for each message	
Feature	This mode cannot be used for S9 related messages (only primary messages) or messages subject to spooning (no secondary message during spooning)	Precise processing is available for each message.	This mode has less effect on existing ladders and is preferred for modifying existing equipment into an on-line system.

The following diagram shows the timing to link relays in each method.

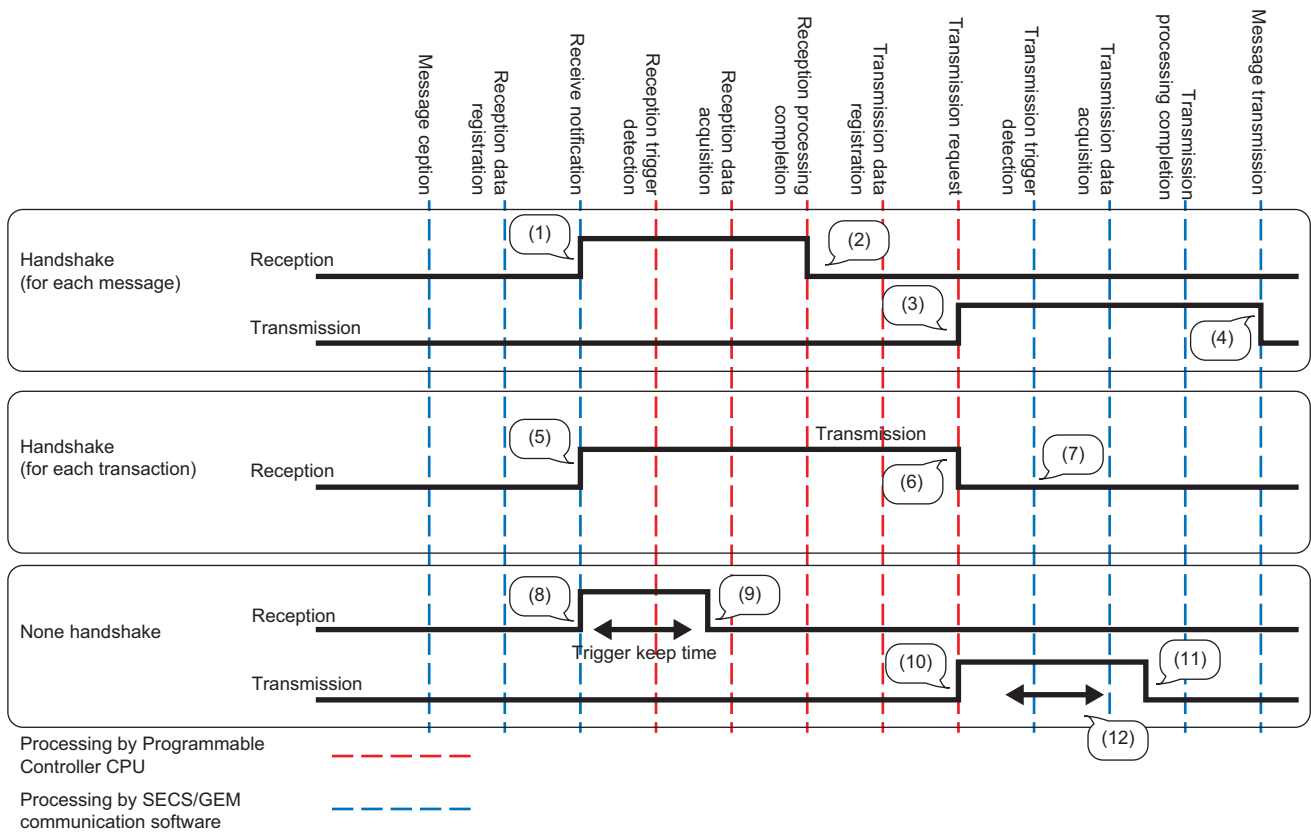

- (1) SECS/GEM communication software starts.
- (2) Programmable Controller CPU turns off.
- (3) Programmable controller CPU starts.
- (4) SECS/GEM communication software turns off.
- (5) The SECS/GEM communication software starts.
- (6) Programmable Controller CPU turns off.
- (7) The sending request trigger is detected by the trigger relay switching OFF. *1
- (8) The SECS/GEM communication software starts.
- (9) SECS/GEM communication software turns off.
- (10) Programmable controller CPU starts.
- (11) Programmable Controller CPU turns off.
- (12) The trigger is detected when the relay remains ON for the predetermined hold time.

*1 The same sequence applies to the transaction from sending request to reception notification.

Handshake (for each transaction)

This section shows the operation flow to link trigger relays by handshakes for each transaction. The following section is an example of when receiving a message from the host.

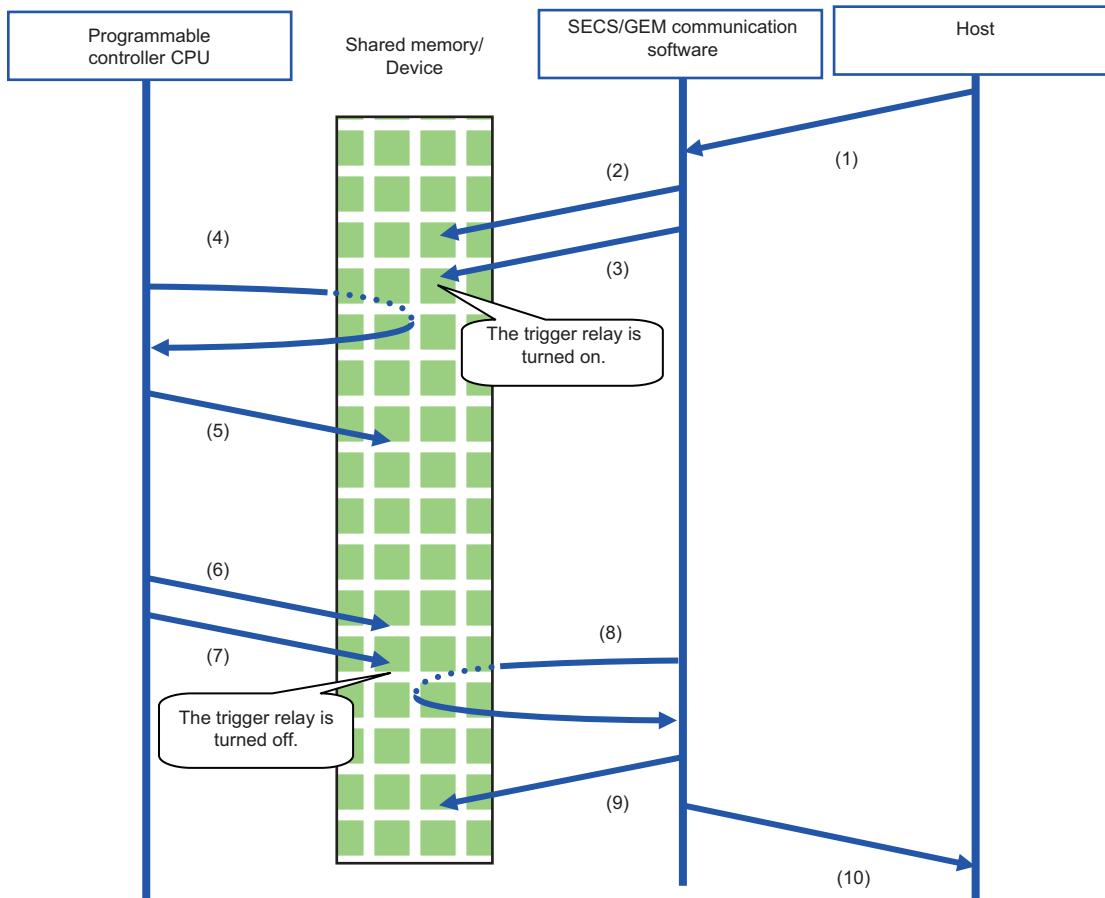

- (1) A message is received from the host.
- (2) The SECS/GEM communication software stores the received data in the shared memory/device.
- (3) SECS/GEM communication software turns the trigger relay ON (OFF→ON control) to inform the Programmable Controller CPU of the reception.
- (4) The programmable controller CPU detects the trigger relay.
- (5) After the programmable controller CPU acquires the received data in the shared memory/device, the received data is processed by a program of the programmable controller CPU. At this time, the programmable controller CPU does not turn the trigger relay OFF.
- (6) The programmable controller CPU configures the sending data to the shared memory/device.
- (7) The Programmable Controller CPU turns the trigger relay OFF (ON→OFF control) to request a transmission.
- (8) The SECS/GEM communication software detects the trigger relay.
- (9) The SECS/GEM communication software acquires the data of the item section of the sending transaction from the shared memory/device of the programmable controller CPU.
- (10) After editing the data into a SECS-II transaction message, SECS/GEM communication software transmits the message to the host.

The procedure when data is sent from the programmable controller CPU is the same as above.

The programmable controller CPU stores the sending data in the shared memory/device, and then turns the trigger relay ON. During return receipt, the SECS/GEM communication software stores the received data in the shared memory/device, and then switches the trigger relay OFF.

After this, the programmable controller CPU acquires the data.

Handshake (for each message)

This section shows the operation flow to link trigger relays by handshakes for each message.
The following section is an example of when receiving a message from the host.

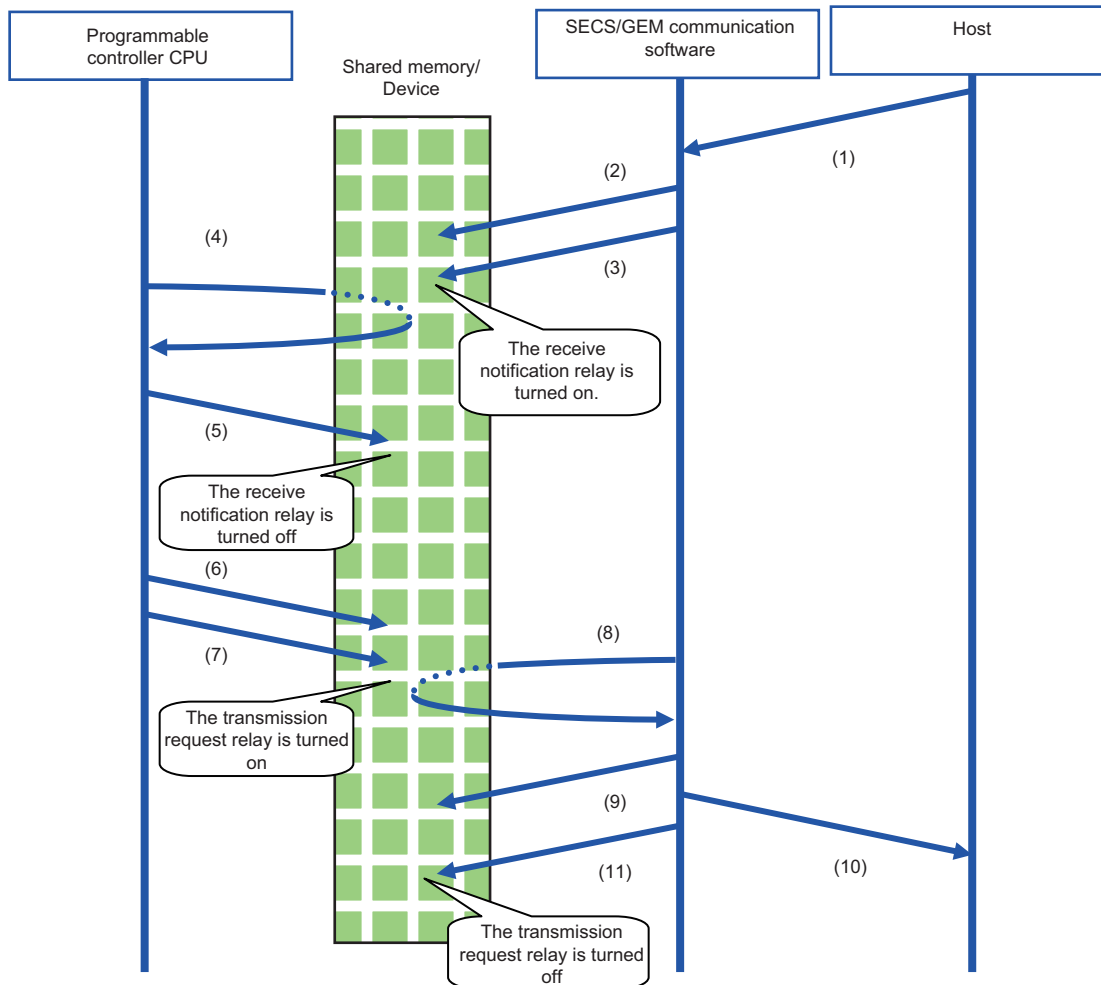

- (1) A message is received from the host.
- (2) The SECS/GEM communication software stores the received data in the shared memory/device.
- (3) SECS/GEM communication software turns the receive notification trigger relay ON (OFF→ON control) to inform the Programmable Controller CPU of the reception.
- (4) The Programmable Controller CPU detects the receive notification trigger on state.
- (5) After the programmable controller CPU acquires the received data in the shared memory/device, it turns the reception notification trigger relay OFF, and then performs response confirmation. (ON to OFF control)
The reception data is processed by a program of the programmable controller CPU.
- (6) The programmable controller CPU configures the sending data to the shared memory/device.
- (7) The Programmable Controller CPU turns the transmission request trigger relay ON (OFF→ON control).
- (8) The SECS/GEM communication software detects the sending request trigger.
- (9) The SECS/GEM communication software acquires the data of the item section of the sending transaction from the shared memory/device of the programmable controller CPU.
- (10) After editing the data into a SECS-II transaction message, SECS/GEM communication software transmits the message to the host.
- (11) The sending request trigger relay is switched OFF. (ON to OFF control)

The procedure when data is sent from the programmable controller CPU is the same as above.

The programmable controller CPU stores the sending data in the shared memory/device, and then turns the sending request trigger relay ON.

During return receipt, the SECS/GEM communication software stores the received data in the shared memory/device, and then switches the reception notification trigger relay ON.

After this, the programmable controller CPU acquires the data.

Important points when configuring to Handshake (for each message)

■ Reception delay

Configure a 20 ms trigger hold time in the settings of secondary message sending for transactions during primary message reception.

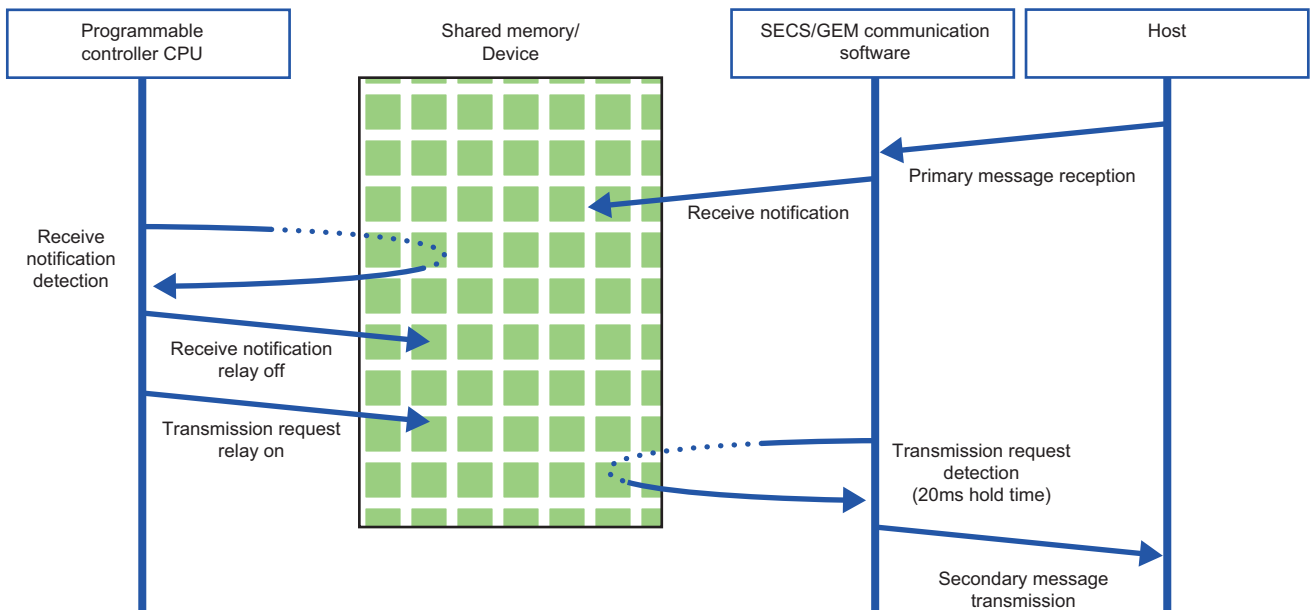

■ Primary message sending after secondary message sending

Make sure that the sending request trigger of the secondary message has been switched OFF by the SECS/GEM communication software after the secondary message was sent and before the primary message of the next transaction is sent.

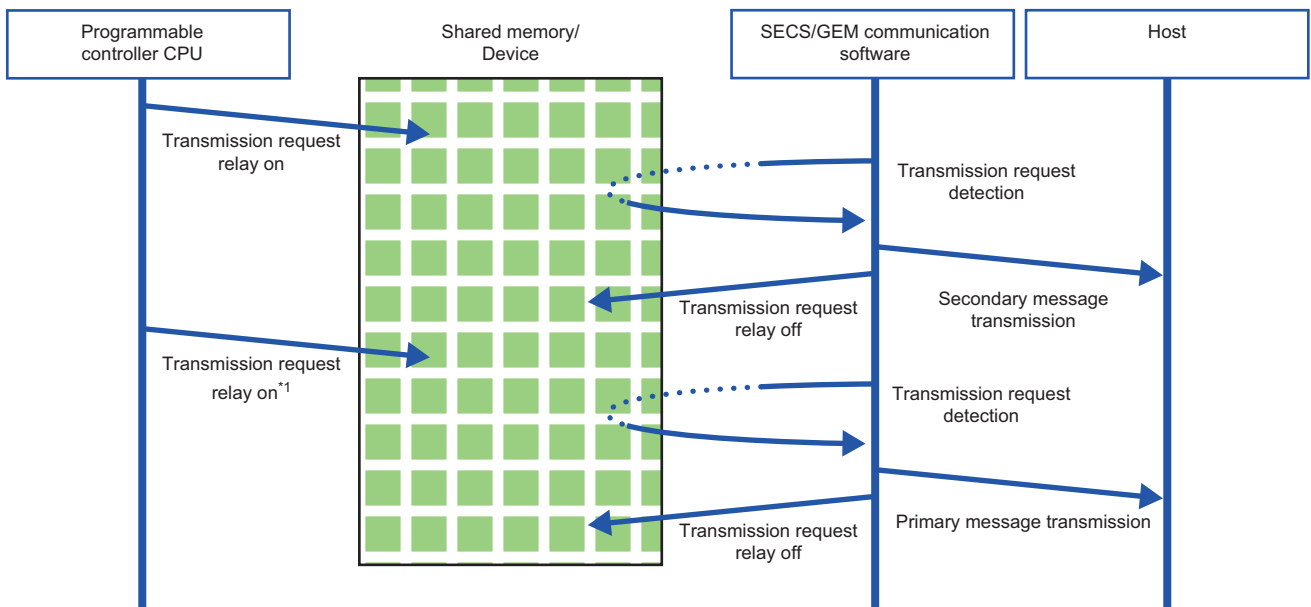

*1 Turns ON after checking that the sending request is OFF.

Handshaking operations for each message

This section shows the handshake operations when message sending was successful, unsuccessful, and canceled.

No.	Event	Description	Operation
1	Transmission completed Spooling succeeded	The message was transmitted. The spool message was spooled.	Sending request trigger relay: OFF
2	Transmission failed Spooling failed	The message was not transmitted (including the message creation failure). The spool message was not spooled.	Sending request trigger relay: Not OFF Transmission failed relay: ON
3	Transmission cancelled	The transmission request was cancelled due to line disconnection or offline status.	Sending request trigger relay: OFF Transmission failed relay: ON

When a message excluded from spooling is sent during spooling, operation depends on the communication state.

- When the communication state is Online, message sending fails.
- When the communication state is Offline or a line disconnection has occurred, sending is canceled.

None handshake

This section shows the operation flow to send messages without using handshakes.

SECS/GEM communication software that receives a message from the host turns the trigger relay for reception notification ON and then OFF.

Similarly, the transmission request relay turned ON by the Programmable Controller CPU should be turned OFF by the Programmable Controller CPU itself.

The following section is an example of when receiving a message from the host.

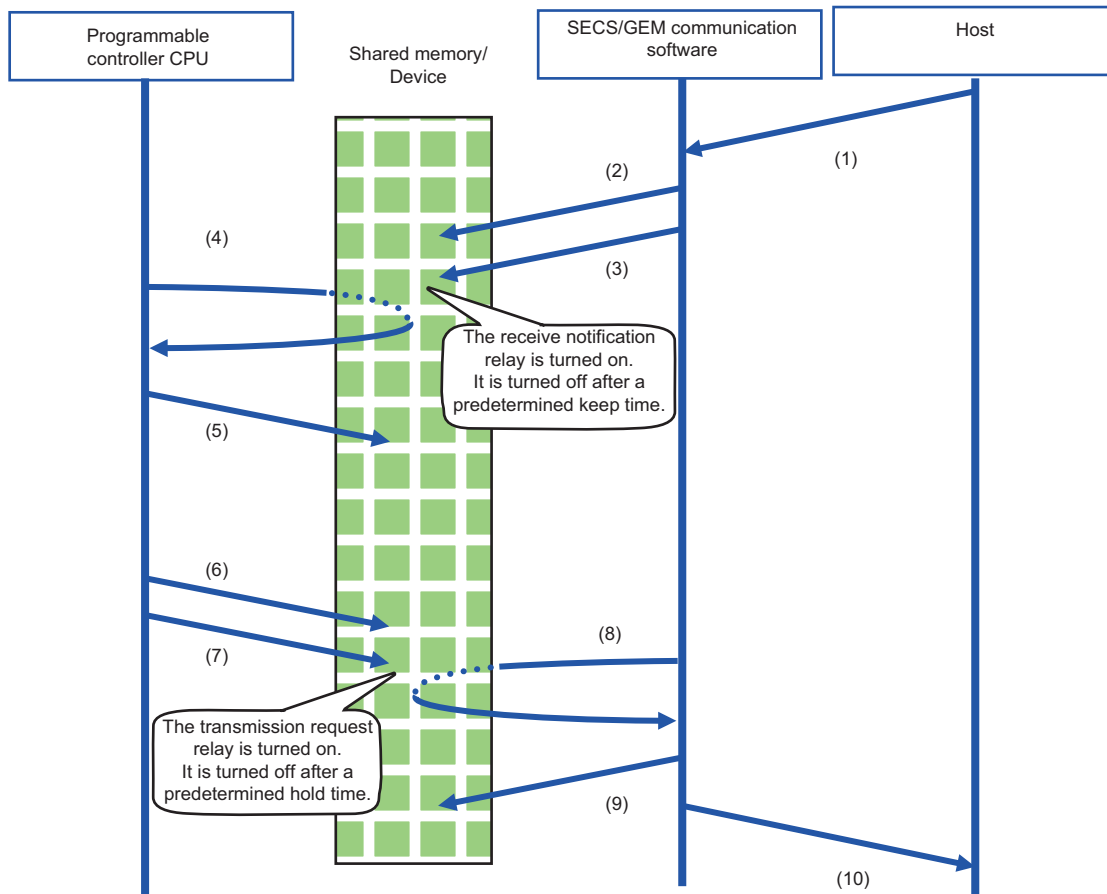

(1) A message is received from the host.

(2) The SECS/GEM communication software stores the received data in the shared memory/device.

(3) SECS/GEM communication software turns the receive notification trigger relay ON (OFF→ON control) to inform the Programmable Controller CPU of the reception.

This receipt notification trigger relay will remain ON for a predetermined time and then be turned OFF by SECS/GEM communication software itself.

(4) The Programmable Controller CPU detects the receive notification trigger on state.

(5) After the programmable controller CPU acquires the received data in the shared memory/device, the received data is processed by a program of the programmable controller CPU.

(6) The programmable controller CPU configures the sending data to the shared memory/device.

(7) The Programmable Controller CPU turns the transmission request trigger relay ON (OFF→ON control).

Note that this sending request trigger relay is switched OFF by the programmable controller CPU after a prescribed hold time.

(8) The SECS/GEM communication software detects the sending request trigger.

(9) The SECS/GEM communication software acquires the data of the item section of the sending transaction from the shared memory/device of the programmable controller CPU.

(10) After editing the data into a SECS-II transaction message, SECS/GEM communication software transmits the message to the host.

The procedure when data is sent from the programmable controller CPU is the same as above.

Periodic message transmission to the host

Message transmission from the Programmable Controller CPU to the host at fixed intervals does not involve trigger handshake.

The following shows the flow:

- 1.** The programmable controller CPU turns ON the sending request trigger relay of a message for which periodic sending is configured after sending data is stored in the shared memory/device of the programmable controller CPU.
- 2.** The SECS/GEM communication software sends periodic messages to the host while an ON status of the sending request trigger relay configured for periodic sending is detected.

If the transmission data is updated by the Programmable Controller CPU during periodic message transmission, subsequently the updated data will be transmitted.

- 3.** The programmable controller CPU turns OFF the sending request trigger relay configured for periodic sending to end the cyclic message sending.

Precautions

When a secondary message was received, turn OFF the reception notification trigger relay.

Otherwise, it causes the reception queue to become full.

How to link with devices

When defining message information and item information, it is possible to use a device as a control register.

It is necessary to configure in advance the device information to link the SECS/GEM communication software pre-installed model module, programmable controller CPU, and I/O unit.

For the configuration procedure, see the following reference.

 Page 65 Device Assignment

Operations of transaction list

Operation	Description
Right-click⇒Shortcut menu[Modify]	Display the Scenario Explorer screen to edit the content of the selected transaction.
Right-click⇒Shortcut menu[Insert]	Insert a new transaction.
Right-click⇒Shortcut menu[Duplicate]	Copy the selected transaction, and then copy the copied transaction to the row below.
Right-click⇒Shortcut menu[Move Up]	Move the selected transaction.
Right-click⇒Shortcut menu[Move Down]	
Right-click⇒Shortcut menu[Delete]	Delete the selected transaction.

Display of transaction data

Series	SECS/GEM communication software		
	Non-GEM version	GEM version	GEM advanced version
MELSEC-Q series	<input type="radio"/>	<input type="radio"/>	<input type="radio"/>
MELSEC iQ-R series	<input type="radio"/>	<input type="radio"/>	<input type="radio"/>

Display the message (primary/secondary) information and item information that belong to transactions.

Window

Select a transaction from the transaction list, right-click⇒Shortcut menu [Edit]

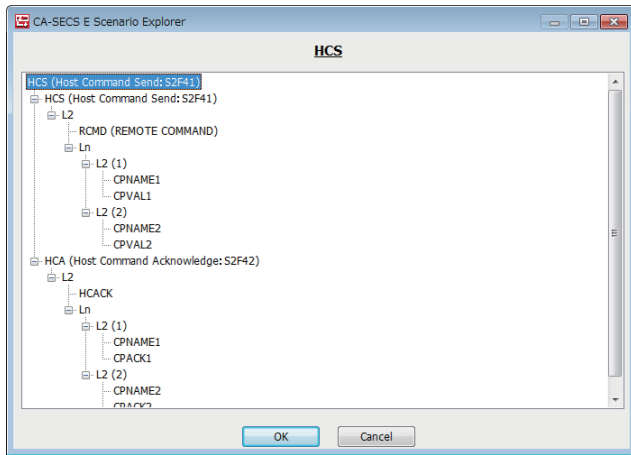

Operations of the Scenario Explorer screen

Operation	Description
Right-click⇒Shortcut menu[Modify]	Edit the content of the selected transaction, message, or item.
Right-click⇒Shortcut menu[Insert Child]	Add the new item data to the level below the selected data.
Right-click⇒Shortcut menu [Insert Sibling Before]	Add the new item data to the same level as the selected data.
Right-click⇒Shortcut menu[Insert Sibling Before]	
Right-click⇒Shortcut menu[Copy]	Copy the selected message/item.
Right-click⇒Shortcut menu[Paste]	Paste the copied data to the position of the selected data.
Right-click⇒Shortcut menu[Paste Insert Child]	Paste the copied data to the level below the selected data.
Right-click⇒Shortcut menu[Paste Insert Sibling Before]	Paste the copied data to the same level as the selected data.
Right-click⇒Shortcut menu[Paste Insert Sibling After]	
Right-click⇒Shortcut menu[Import]	Import the content of the selected message to a .csv file. Data is overwritten by the content to be imported, so take care if the item has already been defined.
Right-click⇒Shortcut menu[Export]	Export the content of the selected message to a .csv file.
Right-click⇒Shortcut menu[Delete]	Delete the selected data.

Point

The message import/export function allows you to edit data using Microsoft Excel or another external editor when the item data is voluminous or redundant.

If some data items are defined and then exported to a file, you can check and edit the content of the item definitions using an external editor. Next, import the results of the editing.

Editing of transaction information definitions

Series	SECS/GEM communication software		
	Non-GEM version	GEM version	GEM advanced version
MELSEC-Q series	<input type="radio"/>	<input type="radio"/>	<input type="radio"/>
MELSEC iQ-R series	<input type="radio"/>	<input type="radio"/>	<input type="radio"/>

Edit the transaction information.

Window

Select a transaction at the "Scenario Explorer" screen, right-click ⇒ Shortcut menu [Edit]

■ Non-GEM version

■ GEM / GEM advanced version

Displayed items

Item	Description
Name	Configure the transaction name. (,),", <, >, ', and & cannot be used.
Comment	Configure the comment. ", <, >, ', and & cannot be used.
Handshake specification	Specify the trigger handshake method. For details on trigger handshakes, see the following reference. ☞ Page 38 Programmable Controller CPU link function
Format specification*1	Specify the format. For details on formats, see the following reference. ☞ Page 51 Format specification
[Advanced Settings] button	Displays the cache setting screen. For details on cache settings, see the following reference. ☞ Page 50 Cache settings

*1 Appears in the non-GEM version only.

Point

When defining a transaction with the same Stream-Function number but a different message configuration, you can configure by distinguishing the transaction name.

Cache settings

This section explains the cache settings.

Configure cache when a large volume of registers defined by I/O assignment are used by item data.

Window

 [Transaction information screen]⇒[Detail]

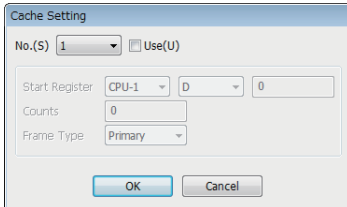

Displayed items

Item	Description
No.	Select the setting number by Handshake (for each transaction).
Use	When cache settings will be used, select the checkbox.
Start Register	Configure the first register to be used.
Counts	Configure the quantity of registers to be used.
Frame Type	Select the frame to use the cache settings (primary message / secondary message / both).

Point

Up to 20 KB can be configured for one cache setting.

Up to 10240 registers can be configured at 20 KB. Up to 2048 shared memory units can be configured at 20 KB.

To obtain maximal performance, edit the related data in the continuous region so that the register range to be registered by the cache setting is reduced as low as possible.

Format specification

Series	SECS/GEM communication software		
	Non-GEM version	GEM version	GEM advanced version
MELSEC-Q series	<input type="radio"/>	—	—
MELSEC iQ-R series	<input type="radio"/>	—	—

Send a reserved transaction frame or special transaction frame configured by the SECS/GEM communication software by an arbitrary frame.

Window

For details on reserved transactions, see the following reference.

☞ Page 268 List of reserved transactions and format

For details on special transactions, see the following reference.

☞ Page 269 Special Transactions

This section shows the settings that can be selected by frame specification.

Setting	Description
NORMAL	Run the action of the general transaction message.
ALARM	<ul style="list-style-type: none"> Send this specification message in place of S5F1 of automatic sending. By selecting ALARM, it is possible to specify ALCD/ALID/ALTX for the storage destination type of items. Because sending is performed automatically by the alarm function, the sending request trigger relay and reception notification trigger relay cannot be configured. For details on alarms, see the following reference. ☞ Page 100 Alarm Definition (non-GEM version)
OFFLINE	Specify when you want to use an arbitrary message as an offline notification. This setting message can be sent by preference due to transition to offline.

Point

Use messages configured to "ALARM" and "OFFLINE" for primary messages of equipment origin. "ALARM" and "OFFLINE" can be specified only for a single message each for all transaction definitions.

Message Information

Series	SECS/GEM communication software		
	Non-GEM version	GEM version	GEM advanced version
MELSEC-Q series	<input type="radio"/>	<input type="radio"/>	<input type="radio"/>
MELSEC iQ-R series	<input type="radio"/>	<input type="radio"/>	<input type="radio"/>

Edit the message information.

Window

Select a message at the "Scenario Explorer" screen, right-click ⇒ Shortcut menu [Edit]

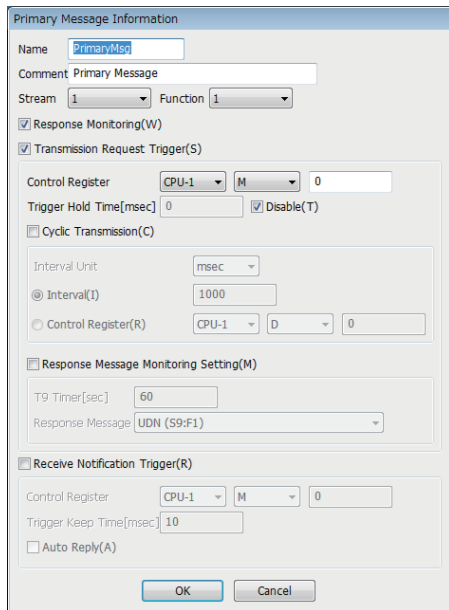

Primary Message Information

Name: PrimaryMsn
 Comment: Primary Message
 Stream: 1 Function: 1

Response Monitoring(W)
 Transmission Request Trigger(S)

Control Register: CPU-1 M 0
 Trigger Hold Time[msec]: 0 Disable(T)

Cyclic Transmission(C)

Interval Unit: msec
 Interval(I): 1000
 Control Register(R): CPU-1 D 0

Response Message Monitoring Setting(M)
 T9 Timer[sec]: 60
 Response Message: UDN (S9:F1)

Receive Notification Trigger(R)
 Control Register: CPU-1 M 0
 Trigger Keep Time[msec]: 10
 Auto Reply(A)

OK Cancel

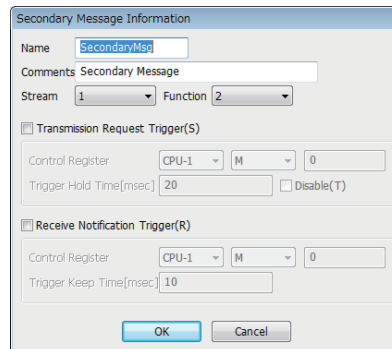

Secondary Message Information

Name: SecondaryMsn
 Comments: Secondary Message
 Stream: 1 Function: 2

Transmission Request Trigger(S)
 Control Register: CPU-1 M 0
 Trigger Hold Time[msec]: 20 Disable(T)

Receive Notification Trigger(R)
 Control Register: CPU-1 M 0
 Trigger Keep Time[msec]: 10

OK Cancel

Displayed items

Item	Description		
Name	Configure the message name.		
Comment	Configure the comment.		
Stream	Select a stream (SECS message section: 1 to 127).		
Function	Select a function (designated message within stream: 1 to 255).		
Response Monitoring	<p>Select this checkbox to monitor the secondary message response corresponding to the primary message sending.</p> <p>When a primary message is sent from the SECS/GEM communication software, the wait bit (W bit) of the primary message is configured to ON, which indicates that there must be a secondary message to the other party.</p>		
Transmission Request Trigger	—	Select this checkbox to send a message by a trigger notification from the programmable controller CPU.	
	Control Register	Configure the sending request trigger relay.	
	Trigger hold time	<p>A sending request trigger results when the sending request trigger relay was held for the configured time.</p> <p>If the "Disable" checkbox is selected, sending request trigger processing is carried out without hold monitoring.</p>	
	Cyclic Transmission* ¹	—	<p>Select this checkbox to send in cycles.</p> <p>When the sending request trigger is ON, sending occurs at the time interval configured for Interval.</p>
		Interval unit	Configure the unit of time for cyclic sending.
		Interval	<p>Select to configure the time interval of cyclic sending.</p> <p>For details on the configurable range, see the following reference.</p> <p>☞ Page 54 Interval unit and configuration range</p>
		Interval Storage Register	<p>Select when a register is used for the Interval setting.</p> <p>For details on the configurable range, see the following reference.</p> <p>☞ Page 54 Interval unit and configuration range</p>
	Response Message Monitor Setting* ¹	—	<p>Select this checkbox when dialog monitoring is necessary for sequence processing between the equipment and host.</p> <p>This time is monitored when the primary message is sent, the secondary message is received, and then the primary message to be received from the host has been determined.</p>
		T9 Timer	Specify the monitoring time.
		Response Message	<p>Select the message subject to receipt monitoring.</p> <p>For details of reserve messages, see the following reference.</p> <p>☞ Page 268 List of reserved transactions and format</p> <p>☞ Page 270 System Error (S9Fx)</p>
Reception Notification Trigger	—	<p>Select this checkbox when message reception is reported to the programmable controller CPU.</p> <p>A trigger notification is sent to the programmable controller CPU during receipt.</p>	
	Control Register	Configure the relay to be the reception notification trigger.	
	Trigger Keep Time	<p>Fill this field when "None" was selected for "Handshake specification" at the "Transaction information" screen.</p> <p>After the reception notification trigger relay is held for the specified time, control switches OFF automatically.</p>	
	Auto Reply* ¹	<p>Select this checkbox to return a response message without waiting for a response from the programmable controller CPU after message receipt.</p> <p>A reception notification handshake is required even for an automatic response.</p>	

*1 Displayed only by the "Primary message information" screen.

Interval unit and configuration range

The following table shows the configurable range of each interval unit.

Interval unit		Setting range	
		Fixed Value	Registers Used
msec	millisecond	1000 to 86400000	1000 to 65535
sec	Second	1 to 86400	1 to 65535
min	Minute	1 to 1440	1 to 1440
hour	Time	1 to 24	1 to 24

Precautions

■T9 timer monitor setting of message information

When an error has occurred due to T9 timer monitoring, a T9 timer timeout notification is sent using the trigger relay from the SECS/GEM communication software.

For details on SECS error notifications, see the following reference.

☞ Page 90 SECS Error Notification Setting

When it is necessary to notify the host of a T9 timer occurrence by S9F13, a new transaction must be defined by the user.

For details on S9F13, see the following reference.

☞ Page 270 System Error (S9Fx)

A primary receipt message is necessary for T9 monitoring. Always configure the reception notification trigger for this primary receipt message.

■When the reception notification trigger is on

The following events occur.

Item	Description
S9 and F3 occurrence	S9 and F3 occur when there is no other definition configured that has the same stream as the message. S9 and F3 also occur when no reception notification trigger has been configured.
S9 and F5 occurrence	S9 and F5 occur when there is one receipt definition or more with the same stream as the corresponding message, and there is no definition that has the same transaction. S9 and F3 also occur when no reception notification trigger has been configured.
Abort Return	Abort return occurs when there is one reception definition or more that has the same stream and function as the corresponding message. In such a case, an error log indicating that the reception notification trigger was not configured is output to the SECS log for primary messages. While the operation ends normally without issuing any notifications for secondary messages, data is not stored in the register.

Item Information

Series	SECS/GEM communication software		
	Non-GEM version	GEM version	GEM advanced version
MELSEC-Q series	<input type="radio"/>	<input type="radio"/>	<input type="radio"/>
MELSEC iQ-R series	<input type="radio"/>	<input type="radio"/>	<input type="radio"/>

Edit the item information.

Window

Select an item at the "Scenario Explorer" screen, right-click ⇒ Shortcut menu [Edit]

Displayed items

Item	Description
Name	Configure the item name.
Comment	Configure the comment.
Data Type	Select the item format code. For more details, see the following reference. ☞ Page 57 Data types (item format codes) To specify an item structure under the item, specify "LIST".
Variable Length	Select this checkbox to configure the data count to a variable length. For more details, see the following reference. ☞ Page 58 Variable Length
Data Counts	Configure the number of items of data to be sent/received. When ASCII or JIS-8 is configured for the data type, configure the character count for this item. When DCHAR was configured for the data type, configure the character count in units of two bytes for this item. For details on the number of units of data that can be set, see the following reference. ☞ Page 57 Data types (item format codes)

Item		Description
Control Register	—	Select when a control register will be used for transmission. <ul style="list-style-type: none"> • During sending: refers to the control register value, and then sends it as item data. • During receipt, refers to the value of the received item data, and then writes it to the prescribed control register.
	Control Register	Configure the control register.
	Data type	The data format can be changed during reception and sending by configuring the "Data type" of the control register. For details of data type conversion, see the following reference. ☞ Page 261 Data type conversion By configuring the conversion table settings in advance, you can select processing to convert register values in accordance with item values. For details of conversion tables, see the following reference. ☞ Page 124 Conversion Table Setting ALCD/ALID/ALTX/AlarmItem1 to 4 can be configured for "Data type" when "ALARM" has been selected for "Format specification" at the "Transaction information" screen. *1 For details on the alarm function, see the following reference. ☞ Page 100 Alarm Definition (non-GEM version)
Fixed Value *2		Select this checkbox to configure the content of sending data to a fixed value, and then configure the value. Up to 30000 alphanumeric characters can be entered for "Fixed Value."
Not set *3		Select this checkbox if the list quantity is determined by the item data structure. In case of a variable, register the list quantity to the control register.
Select List	—	Select this checkbox to configure as the parent list of the select list function. This item can be configured when "LIST" is selected for "Data Type", and the "Variable Length" checkbox has been selected. In the items defined, only items specified by the programmable controller CPU can be sent. In case of reception, items can be saved to the specified register by specifying the key items.
	Select Register	Configure the Select register of the Select list function. <ul style="list-style-type: none"> • During sending From the programmable controller CPU, configure to 1 to enable and 0 to disable. When a relay device was specified, configure the relay to ON to enable this item and to OFF to disable this item. • During reception From the SECS/GEM communication software, configure to 1 if the received data is valid or 0 if it is invalid in comparison with the Select Key Item. When a relay device was specified, configure the relay to ON or OFF when the reception data is valid or invalid.
	Select Key Item	Select this checkbox to configure this item as the key item of the select list function of the reception message.
Repeat Define List	—	Select this checkbox to configure as the parent list of the Repeat Define List function. The setting can be simplified in case of a configuration that repeats the same elements.
	Repeat Item Number	Configure the maximum element quantity of the Repeat Define List function.
	Register offset value	Configure the offset of the register No. of the Repeat Define List function.

*1 Supported by the non-GEM version only.

*2 Displayed when an option other than "LIST" has been selected for "Data Type".

*3 Displayed when "LIST" has been selected for "Data Type".

Precautions

- When the "Select Key Item" checkbox was selected, configure so that the value configured for "Fixed Value" does not overlap with other key items.
- In the case of two or more data sets, the continuous range of the data quantity amount from the specified control register is subject. Make sure not to overlap with any control register specified in other item information.
- When sending an ASCII character string, the specified control register is referenced from the start address. If there is a NULL character midway, a character string from the start point to the NULL character is sent. If the character string is shorter than the specified number of characters to be sent, a NULL character or a space character is inserted into the string depending on the type of terminator defined in the option settings.
- When an ASCII character string was received, the character string is registered to the control register, and then finally a NULL character is registered. The following section shows when the data quantity setting is even or odd.

String [ABCDEF] When (data quantity is 6 (even)) has been received (Control register is configured at D1000)

B	A	D	C	F	E	0000
4241	4241	4241	4241	4241	4241	0000
D1000	D1001	D1002	D1003			

NULL

String [ABCDE] When (data quantity is 5 (odd)) has been received (Control register is configured at D1000)

B	A	D	C	E	
4241	4241	4241	4241	4241	
D1000	D1001	D1002			

NULL

Data types (item format codes)

Item	Description	Number of units of available data			
		MELSEC-Q series		MELSEC iQ-R series	
		Non-GEM version	GEM version, GEM advanced version	Non-GEM version (Ver.1.28E or later) ^{*1}	GEM version, GEM advanced version
LIST	List (length of elements)	No need to specify ^{*2}	No need to specify ^{*2}	No need to specify ^{*2}	No need to specify ^{*2}
BIN	Binary	0 to 1024	0 to 32000	0 to 262144	0 to 1024
BOOL	Truth value	0 to 1024	0 to 32000	0 to 262144	0 to 1024
ASCII	ASCII	0 to 1024	0 to 32000	0 to 262144	0 to 1024
JIS8	JIS8	0 to 1024	0 to 16000	0 to 262144	0 to 512
DCHAR	ASCII	0 to 1024	0 to 16000	0 to 131072	0 to 512
I1	1-byte integer (signed)	0 to 1024	0 to 32000	0 to 262144	0 to 1024
I2	2-byte integer (signed)	0 to 1024	0 to 16000	0 to 131072	0 to 512
I4	4-byte integer (signed)	0 to 1024	0 to 8000	0 to 65536	0 to 256
U1	1-byte integer (unsigned)	0 to 1024	0 to 32000	0 to 262144	0 to 1024
U2	2-byte integer (unsigned)	0 to 1024	0 to 16000	0 to 131072	0 to 512
U4	4-byte integer (unsigned)	0 to 1024	0 to 8000	0 to 65536	0 to 256
F4	4-byte floating-point number	0 to 1024	0 to 8000	0 to 65536	0 to 256
F8	8-byte floating-point number	0 to 1024	0 to 4000	0 to 32768	0 to 128

*1 When using Ver.1.27D or earlier, the number of units of available data is the same as that of non-GEM version of MELSEC-Q series.

*2 When "LIST" is selected for "Data Type," the number of units of data is automatically determined based on the setting of the element in the list.

For more details, see the following reference.

📖 Page 58 Variable Length

Variable Length

The following shows the details on the variable length setting for each selected data type.

■ "LIST" is selected

The following table shows the operations when "LIST" is selected for "Data Type" and the checkbox of "Variable Length" is selected:

Message type	Operation
Sending message	Refers to the control register, and then determines the list quantity. Example: When the list structure was defined by 10 items by the message definition, and the value of the register referenced for the list quantity is "6" during sending, data of 6 items is sent.
Reception message	Registers the quantity of the received item data to the control register. Example: When the list structure was defined by 10 items by the message definition, and data of 7 items was received during reception, "7" is registered to the control register.

■ An item other than "LIST"^{*1} is selected

When an item other than "LIST"^{*1} is selected for "Data Type" and the checkbox of "Variable Length" is selected, two methods are available to specify the number of units of data: compatibility mode and extended mode.

*1 Excluding ASCII and JIS8.

Specify the number of units of data in the extended mode when sending items with 65535 or more units of data.

The compatibility mode and extended mode are automatically switched according to the number of units of data in a received item at the time of receiving.

The following table shows the methods for specifying the number of units of data in the compatibility mode and extended mode.

Item	Compatibility mode	Extended mode
Number of words in the start area of a control register	1 word	3 words
Contents stored in the start area of a control register	Number of units of data to send and receive (1 word)	Identifier (65535 (0xFFFF)) (1 word) Number of units of data to send and receive (2 words)
Number of units of data when sending an item ^{*2}	0 to 65534 (0x0000 to 0xFFFE)	0 to 262144 (0x00000000 to 0x00040000)
Number of units of data when receiving an item ^{*2}	0 to 65534 (0x0000 to 0xFFFE)	65535 to 262144 (0x0000FFFF to 0x00040000)

*2 The upper limit of the number of units of data that can be sent and received differs depending on the data type.
For more details, see the following reference.

☞ Page 57 Data types (item format codes)

■ Compatibility mode (when the start value of the control register is 0 to 65534)

Ex.

Data type: U2 (2-byte integer (unsigned))

Control register: D0

Value of D0: 3 (0x0003)

Data to send and receive: 0x0123, 0x4567, 0x89AB (3 words)

D0	0x0003	(1)
D1	0x0123	(2)
D2	0x4567	
D3	0x89AB	
⋮	⋮	

(1) Number of units of data to send and receive

(2) Data to send and receive

■Extended mode (when the start value of the control register is 65535)

Ex.

Data type: U2 (2-byte integer (unsigned))

Control register: D0

Value of D0: 65535 (0xFFFF)

Data to send and receive: 0x0123, 0x4567, 0x89AB, ...0x89AB (131072 words)

D0	0xFFFF	(1)
D1	0x0000	(2)
D2	0x0002	
D3	0x0123	(3)
D4	0x4567	
D5	0x89AB	
⋮	⋮	
D131074	0x89AB	

(1) Identifier

(2) Number of units of data to send and receive

(3) Data to send and receive

Special data type conversion

When the data type is configured to "ASCII" in the sending message setting, [DATE-A], [DATE-Q], [TIME16], [TIME14], [TIME12], and/or conversion table (when defined) options will be available.

The [DATE-A] and [DATE-Q] are used when the item data is ASCII time data.

For reception data, ASCII time data is converted to numerical time data and registered to a specified register. For sending data, the register is referenced, and then the data is converted to ASCII time data and sent.

For details of data type conversion, see the following reference.

☞ Page 261 Data type conversion

[TIME16], [TIME14], and [TIME12] are used to configure and send the calendar data held by the SECS/GEM communication software pre-installed model module to the item data.

- [TIME16]: 16-byte format (YYYYMMDDhhmmsscc)
- [TIME14]: 14-byte format (YYYYMMDDhhmmss)
- [TIME12]: 12-byte format (YYMMDDhhmmss)

If conversion of these data types was specified by the reception frame, the time of the SECS/GEM communication software pre-installed model module is overwritten. It is not registered to a register.

Message structure of the SECS/GEM communication software pre-installed model module

Calculate the byte length of the actual item data, and then configure the maximum length of the message using up to 5 MB as reference.

When the MELSEC iQ-R series SECS/GEM communication software pre-installed model module is used, the maximum item count of one message is 3000.

Item	Description
Transmission buffer	Messages of up to 5 MB can be transmitted. The transmission buffer may be exceeded depending on the communication status.
Log Output	Messages of up to 5 MB can be logged. However, this is exceeded during logging of another message, and only the header is logged.

If too much data is transmitted, the SECS/GEM communication software operates in the following manner.

Operation	Description
Many transactions that have large messages have been defined	The CIM control READY relay does not switch ON. (The SECS/GEM communication software does not start)
An excessive message was sent	Sending fails.
A primary message that became an excessive message was received	An abort message is returned, and there is no writing to the prescribed register. (S9F11)
A secondary message that became an excessive message was received	Abort reception is reported, and there is no writing to the prescribed register.

7.4 Communication Setting

Configure the communication method.

SECS communication configuration

Series	SECS/GEM communication software		
	Non-GEM version	GEM version	GEM advanced version
MELSEC-Q series	<input type="radio"/>	<input type="radio"/>	<input type="radio"/>
MELSEC iQ-R series	<input type="radio"/>	<input type="radio"/>	<input type="radio"/>

Configure the SECS communication method, various timer times, and other parameters.

Window

 [Setting]⇒[Communication Setting]

Displayed items

Item		Description	
Port Type		Select the communication method used for SECS communication (SECS1 ^{*1} /HSMS).	
Device ID		Configure the device ID of the SECS/GEM communication software.	
SECS-I	Serial port	Select the COM port number used for SECS communication (COM1 only).	
	Master/Slave	Select the master or slave of serial communication.	
	Baud Rate	Select the communication speed of the RS-232C port.	
	Number of Retries	Select the number of retries when data sending fails.	
	Serial setting	Data Length	Select the length of one data item.
		Parity	Select the parity check method.
		Stop Bit	Select the stop bit.
		Flow Control	Select the handshake method.
	Timer setting	T1	Select the timeout time between reception characters.
		T2	Select the protocol timeout time.
T3		Select the response timeout time.	
T4		Select the inter-block timeout time.	
HSMS	Connection mode (Passive/Active)	Select an HSMS connection method from Passive (wait to receive a connection procedure) or Active (initiate a connection procedure with the destination).	
	IP address (Local)	Configure the IP address of the SECS/GEM communication software used for HSMS communication.	
	IP Address (Remote)	Configure the IP address of the connection destination used for HSMS communication.	
	IP Port (Local)	Configure the port number of the SECS/GEM communication software used for HSMS communication.	
	IP Port (Remote)	Configure the port number of the connection destination used for HSMS communication.	
	Timer setting	Link Test Timer	Configure the fixed interval at which the destination link test is performed.
		T3	Select the response timeout time.
		T5	Select the connection separation timeout time.
		T6	Select the control transaction timeout time.
T7		Select the Not Selected timeout time.	
T8	Select the timeout time between network characters.		

*1 Can be selected for only the MELSEC-Q series SECS/GEM communication software pre-installed model module.

Precautions

- If it is necessary to send a multi-block permission frame to the host when sending multiple blocks with SECS-I communication, define the transaction separately, and then carry out sending processing.
- The "T5" setting of HSMS communication is synchronized with the Reconnection delay after Line Disconnection setting of the [Control 1] tab of the Option settings.

Communication Setting by PLC

Series	SECS/GEM communication software		
	Non-GEM version	GEM version	GEM advanced version
MELSEC-Q series	<input type="radio"/>	<input type="radio"/>	<input type="radio"/>
MELSEC iQ-R series	<input type="radio"/>	<input type="radio"/>	<input type="radio"/>

Change the communication setting by the value acquired from the register.

You can configure the parameters of the communication method selected by "Port type" of the "Communication settings" screen.

Window

 [Setting]⇒[Communication Setting by PLC]

Displayed items

Item	Description
Communication Setting by PLC	Select this checkbox to change communication settings from a ladder program.
Device ID	Configure the reference-destination register of the device ID value to be changed. The Device ID parameter is necessary for both SECS-I and HSMS.
Setting Request Trig	Configure the trigger relay to apply setting information.
SECS-I	Configure the reference-destination register of the parameter value. For the value to be stored to the register, see the following reference. Page 64 SECS-I configuration
HSMS	Configure the reference-destination register of the parameter value. For the value to be stored to the register, see the following reference. Page 64 HSMS settings

Operating procedure

1. Start the SECS/GEM communication software.
During start-up, the current setting values of the SECS/GEM communication software are applied to the register.
2. The register value is changed, and the setting trigger is configured to ON.
The setting value of the SECS/GEM communication software is changed by the register value, and the setting trigger is configured to OFF by the SECS/GEM communication software.
When an invalid value has been configured to the register, the register value returns to the value before the change.
3. Reset the programmable controller CPU.

Precautions

Configure the register settings by programmable controller CPU management or the I/O Assignment section.

SECS-I configuration

The following section shows the SECS-I parameter values stored to registers.

Item		Setting value	
Device ID		0 to 32767	
Setting Request Trig		Trigger relay to apply setting information.	
SECS-I	Serial port	"1" only.	
	Master/Slave	<ul style="list-style-type: none"> • 0: Master • 1: Slave 	
	Communication speed [bps]	9600, 14400, 19200, 38400, 57600, and 115200 only (Only 2 consecutive registers are used.)	
	Number of Retries	0 to 31	
	Serial setting	Data Length	<ul style="list-style-type: none"> • 7: B7 • 8: B8
		Parity	<ul style="list-style-type: none"> • 0: PN • 1: P0 • 2: PE
		Stop Bit	<ul style="list-style-type: none"> • 1: S1 • 2: S2
		Flow Control	<ul style="list-style-type: none"> • 0: NON • 1: XON • 2: RTS
	Timer setting	T1	100 to 10000 (increments of 100)
		T2	200 to 25000 (increments of 200)
T3		1 to 120 (increments of 1)	
T4		1 to 120 (increments of 1)	

HSMS settings

The following section shows the HSMS parameter values stored to registers.

Item		Setting value	
Device ID		0 to 32767	
Setting Request Trig		Trigger relay to apply setting information.	
HSMS	Connection mode	<ul style="list-style-type: none"> • 0: Active • 1: Passive 	
	IP address (Local)	(0 to 255) (Four consecutive registers are used.)	
	IP Address (Remote)	(0 to 255) (Four consecutive registers are used.)	
	IP Port (Local)	1 to 65535	
	IP Port (Remote)	1 to 65535	
	Timer setting	Link Test Timer	1 to 65535
		T3	1 to 120 (increments of 1)
		T5	1 to 240 (increments of 1)
		T6	1 to 240 (increments of 1)
		T7	1 to 240 (increments of 1)
T8		1 to 120 (increments of 1)	

7.5 Device Assignment

Configure the range of each device type used by the SECS/GEM communication software.
There are 2 types of device assignment: shared memory and I/O assignment.

Precautions

The device assignment settings differ with the shared memory settings for the programmable controller CPU and SECS/GEM communication software pre-installed model module.

Shared Memory Setting

Series	SECS/GEM communication software		
	Non-GEM version	GEM version	GEM advanced version
MELSEC-Q series	<input type="radio"/>	<input type="radio"/>	<input type="radio"/>
MELSEC iQ-R series	—	—	—

When the refresh area in the multi-CPU settings of the programmable controller CPU and MELSEC-Q series SECS/GEM communication software pre-installed model module is used by the SECS/GEM communication software, configure the refresh area as shared memory.

Window

 [Setting]⇒[Device Assign Setting]

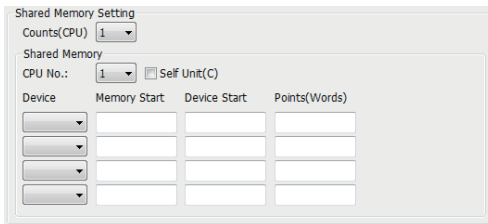

Displayed items

Item	Description	
Counts(CPU)	Select the number of programmable controller CPUs.	
Shared Memory	CPU No.	Select the number of a CPU.
	Self Unit	Select this checkbox to allocate for the MELSEC-Q series SECS/GEM communication software pre-installed model module.
	Device	Select a device.
	Memory Start	Configure the start of a memory number in the programmable controller CPU or MELSEC-Q series SECS/GEM communication software pre-installed model module.
	Device Start	Configure the start of device numbers.
Counts(Words)	Configure the number of devices to be used in units of words.	

Ex.

For a 2 device configuration of the programmable controller CPU and MELSEC-Q series SECS/GEM communication software pre-installed model module, configure M device to 256 points and D device to 1024 points, respectively.

Device	Memory Start	Device Start	Points(Words)
M	0	0	16
D	16	0	1024

Device	Memory Start	Device Start	Points(Words)
M	0	256	16
D	16	1024	1024

Using Shared Memory

The following section shows the advisability of using the shared memory by the type of transmission message.

Refresh range	Device configuration example	Transmission message		Availability
Within programmable controller CPU	M0 to M255	Sending	Programmable controller CPU turns trigger ON • SECS/GEM communication software detects trigger by automatic refresh • SECS/GEM communication software directly turns trigger device OFF to establish trigger handshake	Available
		Receiving	SECS/GEM communication software directly turns trigger device ON • Programmable controller CPU detects trigger and turns device OFF. • SECS/GEM communication software detects trigger by automatic refresh to establish trigger handshake	Available
	D0 to D1023	Sending	Programmable controller CPU writes data to register	Available
		Receiving	SECS/GEM communication software directly controls device and writes data to register *1	Available
Within C Controller module	M256 to M511	Sending	Programmable controller CPU turns trigger ON • This action will not rewrite the refresh area of the C Controller module, so the shared memory is not available. Suitable for assignment of CA status notification setting.	Not available
		Receiving	SECS/GEM communication software directly turns trigger device ON • Programmable controller CPU detects trigger and turns device OFF. • This action will not rewrite the refresh area of the C Controller module, so the shared memory is not available.	Not available
	D1024 to D2047	Sending	Writing data to the register by the programmable controller CPU will not rewrite the refresh area of the C Controller module, so the shared memory is not available.	Not available
		Receiving	SECS/GEM communication software writes data to refresh area • Programmable controller CPU can refer to the refresh area as a device.*1,*2	Available

*1 Higher speed performance can be obtained if items contained in the received message are written in the refresh area.

*2 If a device in which received data is stored is not updated when a reception notification trigger is detected, use a device in the I/O assignment area for which the cache settings are configured instead of the refresh area.

■When it is not possible to secure a region for transmission messages by shared memory

Configure and use devices of the programmable controller CPU by I/O assignment.

In the region of I/O assignment, the SECS/GEM communication software controls devices directly. Configure the cache settings to ensure performance.

For details on cache settings, see the following reference.

📖 Page 50 Cache settings

I/O assignment

Series	SECS/GEM communication software		
	Non-GEM version	GEM version	GEM advanced version
MELSEC-Q series	<input type="radio"/>	<input type="radio"/>	<input type="radio"/>
MELSEC iQ-R series	<input type="radio"/>	<input type="radio"/>	<input type="radio"/>

The I/O assignment needs to be configured for the SECS/GEM communication software to use the devices of the programmable controller CPU, SECS/GEM communication software pre-installed model module, or I/O module.

Window

[Setting]⇒[Device Assign Setting]

■MELSEC-Q series

■MELSEC iQ-R series

Displayed items

Item	Description
Channel*1	Select "Q-bus".
Network number*1	Do not enter data.
STA#*1	Configure the CPU number. Use the device function of the Setting/Monitoring Tools for the C Controller module to configure the station number to "255" (own station) to access the station device ("M" or "D").
CPU number *2	Configure the CPU number of the control CPU.
Device	Select a device.
Device Start	Configure the start of device numbers.
Counts(Words)	Configure the number of devices to be used in units of words. <ul style="list-style-type: none"> When a MELSEC-Q series SECS/GEM communication software pre-installed model module will be used, and relay devices only are configured by I/O assignment for relay devices (M, B, X, and Y), a maximum of 4096 points (256 words) can be used in total. When a MELSEC iQ-R series SECS/GEM communication software pre-installed model module will be used, and relay devices only are configured by I/O assignment for relay devices (M, B, X, and Y), a maximum of 3584 points (224 words) can be used in total. For each I/O assignment record other than a relay device, the maximum number of points for relay devices is decreased by 256 points (16 words). Relay devices are recommended to be set in units of 256 points (16 words). The maximum number of points for relay devices is decreased for the points less than 256.

*1 Displayed for only the MELSEC-Q series SECS/GEM communication software pre-installed model module.

*2 Displayed for only the MELSEC iQ-R series SECS/GEM communication software pre-installed model module.

Available device ranges

The following table shows the device ranges to set for the I/O assignment.

Module	SECS/GEM communication software	Device range
MELSEC iQ-R series SECS/GEM communication software pre-installed model module	Non-GEM version*1	M, B, X, Y: 0 to 32767 D, W, R, ZR: 0 to 2147483647
	GEM version	M, D, B, X, Y, W, R: 0 to 32767
	GEM advanced version	ZR: 0 to 65535
MELSEC-Q series SECS/GEM communication software pre-installed model module	Non-GEM version	M, D, B, X, Y, W, R: 0 to 32767
	GEM version	ZR: 0 to 2147483647
	GEM advanced version	

*1 When using Ver.1.27D or earlier, the following devices can be used:

M, D, B, X, Y, W, R: 0 to 32767

ZR: 0 to 65535

Precautions

In the region of I/O assignment, the SECS/GEM communication software controls devices directly. Configure the cache settings to ensure performance.

For details on cache settings, see the following reference.

 Page 50 Cache settings

7.6 Option Setting

Configure the advanced operations of the SECS/GEM communication software.

Control 1

Series	SECS/GEM communication software		
	Non-GEM version	GEM version	GEM advanced version
MELSEC-Q series	<input type="radio"/>	<input type="radio"/>	<input type="radio"/>
MELSEC iQ-R series	<input type="radio"/>	<input type="radio"/>	<input type="radio"/>

Window

[Setting] ⇒ [Option Setting] ⇒ [Control 1] tab

■ MELSEC-Q series

■ MELSEC iQ-R series

Displayed items

Item	Description
PLC Response Monitoring Timer	<p>Configure the monitoring time from when the SECS/GEM communication software turns ON the programmable controller CPU reception notification relay to when the programmable controller CPU turns the relay OFF to confirm the handshake.</p> <p>If the relay is ON after the specified time passes, the SECS/GEM communication software turns the relay OFF.</p> <p>For the operation of the PLC Response Monitoring Timer, see the following reference.</p> <p>☞ Page 72 PLC Response Monitoring Timer and Secondary Monitoring Timer</p>
Secondary Monitoring Timer	<p>Configure the monitoring time from when a primary message is received, and the SECS/GEM communication software turns ON the reception notification trigger relay to when the programmable controller CPU turns the secondary message sending request trigger relay ON.</p> <p>If the secondary message sending request trigger relay was not switched ON after the specified time has past, the programmable controller CPU is notified if there are queued received messages. The setting must be larger than the PLC Response Monitoring Timer.</p> <p>For the operation of the Secondary Monitoring Timer, see the following reference.</p> <p>☞ Page 72 PLC Response Monitoring Timer and Secondary Monitoring Timer</p>
Reconnection Delay After Line Disconnection	<p>Configure the delay time until a reconnection is attempted when a disconnection was detected. Reconnection Delay After Line Disconnection is synchronized with the T5 timer setting.</p>
Maximum Number Of Retries After Line Disconnection	<p>Configure the number of reconnection attempts when a disconnection was detected. Setting the maximum number of retries to "∞" (infinity) results in an infinite number of retries.</p>
Transaction Response Monitoring Timer ^{*1}	<p>Configure the time from when a transaction is executed to when the next transaction is executed in the course of a scenario that sequentially executes a series of transactions.</p> <p>For details of scenario settings, see the following reference.</p> <p>☞ Page 97 Scenario definition</p>
ASCII Character Terminator	<p>When the ASCII data type is selected for SECS sending data, and the actual number of characters is fewer than the predetermined number, specify the space filling method (NULL character or space character).</p> <p>When the sending data is configured as a fixed value, a number of characters that is fewer than the number of SECS data sets is still valid.</p> <p>Sending string data is referenced from the start control register. If there is a NULL character midway, a character string from the start point to the NULL character is sent.</p>
Number of Multi-Transaction Queues For PLC Transaction	<p>For operation and configuration of the number of multi-transaction queues, see the following reference.</p> <p>☞ Page 73 Configuration of number of multi-transaction queues</p>
Number of Transaction Queues For PLC Transaction	
Number of Multi-Transaction Queues For PLC Receiving	
Switch Into Offline Status Upon Disconnection ^{*2}	<p>Select this checkbox to switch the system into offline status upon detection of line disconnection. After the status has switched to offline, the SECS/GEM communication software turns OFF the online status of CA status notification.</p> <p>When this checkbox is cleared, the online status continues even after detection of line disconnection.</p>

Item	Description
Use S1F13 For The Communication Establishment Sequence	<p>Select this checkbox to consider a communication request transaction (S1F13/14) as the necessary condition for establishing communication between the equipment and host.</p> <p>The following operations are performed depending on the checkbox state.</p> <ul style="list-style-type: none"> • Selected: When the communication request transaction (S1F13/14) is executed, communication is established, and the communication established relay turns ON. Any other transactions are discarded before communication is established. • Cleared: The communication request transaction (S1F13/14) is considered as a normal transaction. For an HSMS connection, communication is established when the state is HSMS Selected, and the communication established relay turns ON. For an SECS-I connection, communication is established when the SECS/GEM communication software opens the port immediately after start-up. <p>For details on the Communication established relay, see the following reference. ☞ Page 82 CA Status</p>
Set communication as disconnected by a T3 timeout ^{*3}	<p>When a T3 timeout has occurred after a primary message was sent from the SECS/GEM communication software, this is treated as a sending failure, and a communication-disconnected state results. Select this checkbox to turn OFF the Communication established relay.</p> <p>If this checkbox is not selected, the Communication established state is maintained even after a T3 timeout.</p> <p>For details on the Communication established relay, see the following reference. ☞ Page 82 CA Status</p>
Set communication as disconnected by receipt of an abort of message subject to spooling ^{*3}	<p>When an abort message is received from the host after a message subject to spooling was sent from the SECS/GEM communication software, this is treated as a sending failure, and a communication-disconnected state results. Select this checkbox to turn OFF the Communication established relay.</p> <p>Furthermore, if the Communication established relay turns OFF, spooling occurs simultaneously. If this checkbox is cleared, communication remains established, and spooling is not performed even when an abort message is received from the host.</p> <p>For details on the Communication established relay, see the following reference. ☞ Page 82 CA Status</p>
Automatically Transmit S1F13 Upon Line Reconnection ^{*4}	<p>Select this checkbox to cause the SECS/GEM communication software to automatically send S1F13 when the communication line is reconnected after disconnecting.</p> <p>When this checkbox is cleared, automatic sending is not performed, so the programmable controller CPU needs to request sending.</p>
Send An Abort Message Before Transmitting S9Fx	<p>When a primary message, such as an undefined device ID message, is received from the host, the SECS/GEM communication software automatically sends an S9 related error message.</p> <p>Select this checkbox to interrupt the transaction associated with the received primary message and send an abort message (SnF0: "n" indicates the S code of the reception message).</p> <p>For content of S9 errors, see the following reference. ☞ Page 270 System Error (S9Fx)</p>
Send Complete Waiting Timer ^{*5}	<p>Configure the time to monitor from when the SECS/GEM communication software starts the sending process for a message until the completion of sending.</p> <p>If the transmission is not completed within the configured timer value (default: 20 seconds), "DM sending failure" is output to the SECS log.</p> <p>In such a case, configure a large Send Complete Waiting Timer value.</p>

*1 Can be configured for only the MELSEC-Q series SECS/GEM communication software pre-installed model module.

*2 If the "Control State Model" checkbox has been selected under GEM Performance Definition Setting in the GEM version or GEM advanced version, operation is based on the control state model regardless of this setting.

*3 Can be configured only by a non-GEM version.

*4 If the "Communication State Model" checkbox has been selected under GEM Performance Definition Setting in the GEM version or GEM advanced version, this setting is always enabled, regardless of the status of the checkbox.

*5 Can be configured for only a GEM version and GEM advanced version.

Precautions

- Before configuring the number of transaction cues, check the advisability and quantity of interleaving (simultaneous processing of multiple transactions) in the specifications of the host.
- When S1F13 is used in the communication establishment sequence, a communication established state cannot occur until a communication establishment request transaction (S1F13/14) is established. Therefore, the S1F13/14 transaction must be defined.
- When [Communication state model] is enabled in GEM performance definition / basic requirements of GEM, a GEM version of the SECS/GEM communication software operates as though the checkbox was selected, regardless of the "Use S1F13 For The Communication Establishment Sequence" setting.
- An abort message is not returned if the primary message to be received has no return request (W-bit), even if "Send An Abort Message Before Transmitting S9Fx" is set. Note that S9F9 (transaction timeout) is a timeout for sending messages and is not covered by this setting.

PLC Response Monitoring Timer and Secondary Monitoring Timer

■Handshake for each transaction

The PLC Response Monitoring Timer monitors the time from "(2) Reception notification trigger relay ON" to "(6) Sending request detection". The Secondary Monitoring Timer is not used for a handshake for each transaction.

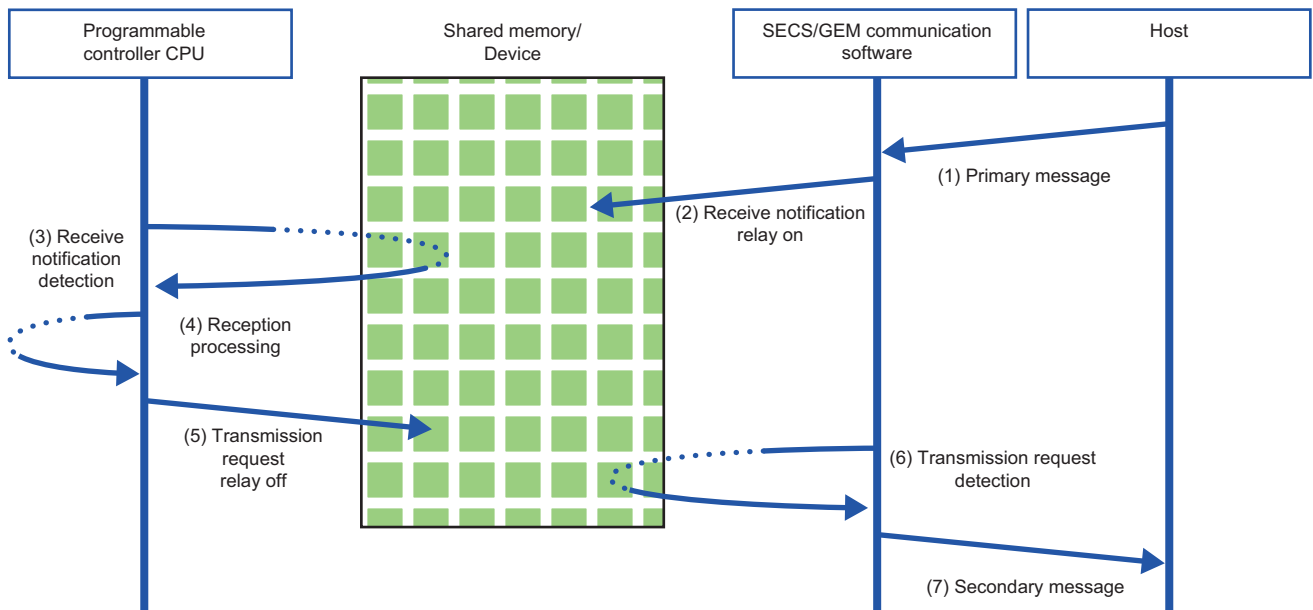

■Handshake for each message

The PLC Response Monitoring Timer monitors the time from "(2) Reception notification trigger relay ON" to "(4) Reception notification trigger relay OFF". Furthermore, the Secondary Monitoring Timer monitors the time from "(2) Reception notification trigger relay ON" to "(6) Sending request trigger relay ON".

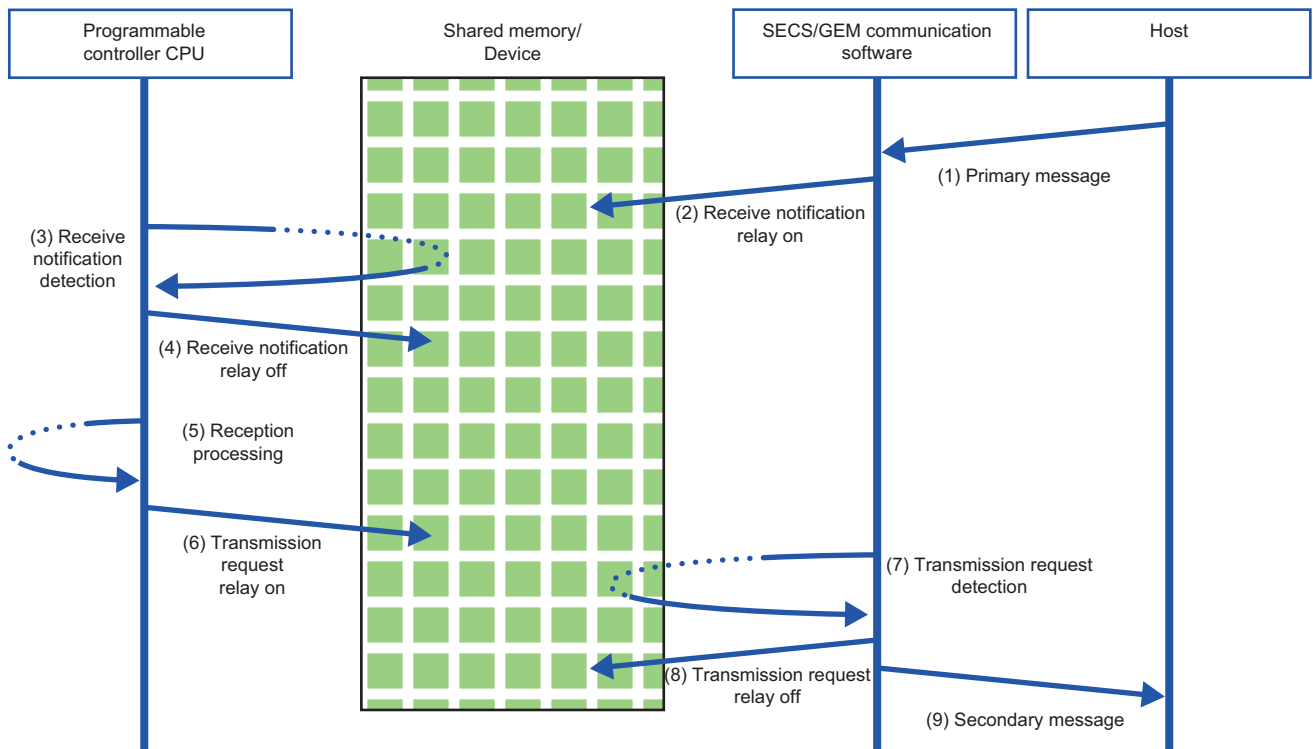

Configuration of number of multi-transaction queues

For multi-transactions, the next primary message is issued without waiting for the arrival of the prescribed secondary message. (In the case of single transactions, the next transaction is never issued until a secondary message is sent for a primary message.)

If interleaving (simultaneous processing of multiple transactions) is required, the number of multi-transaction queues should be configured to two or more according to the communication specifications.

The following table shows the objectives and operations of each multi-transaction queue.

Item	Objective	Operation
Number of Multi-Transaction Queues For PLC Transaction	Configure the number of primary messages that can be sent simultaneously.	Messages are queued in the sending transaction queue when the queue is full.
Number of Transaction Queues For PLC Transaction	Configure the number of queued messages that can be retained simultaneously.	Any subsequent messages are discarded when the queue is full. (Sending failure)
Number of Multi-Transaction Queues For PLC Receiving	Configure the number of received messages that can be retained simultaneously.	Any subsequent messages are aborted when the queue is full.

■ Operation when the "Number of Multi-Transaction Queues For PLC Transaction" has been configured multiple times

Messages of the number specified by "Number of Multi-Transaction Queues For PLC Transaction" are sent simultaneously. When the Number of Multi-Transaction Queues For PLC Transaction becomes full, messages that arrive later are accumulated (interleaved) in the Number of Transaction Queues For PLC Transaction.

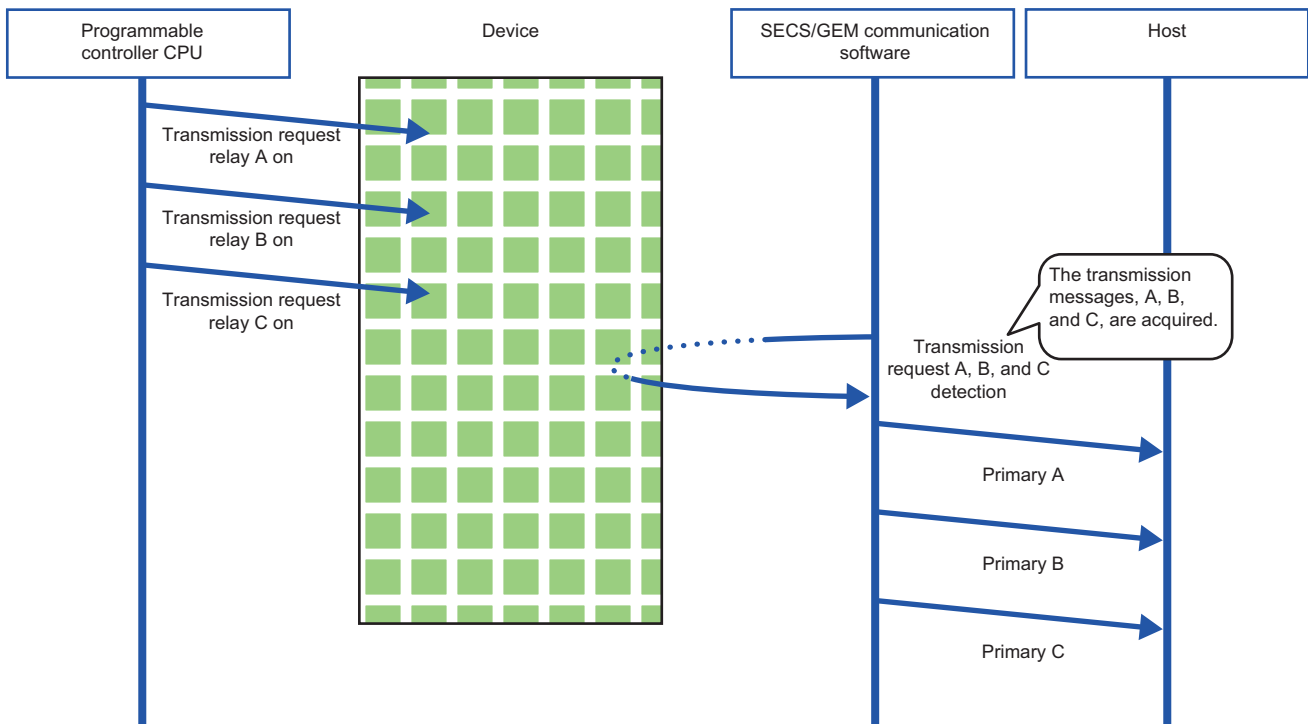

Precautions

If the Number of Transaction Queues For PLC Transaction becomes full, sending fails and later messages are discarded. When "Number of Multi-Transaction Queues For PLC Transaction" has been configured multiple times, configure "Number of Transaction Queues For PLC Transaction" multiple times as well.

■ Operation when the "Number of Multi-Transaction Queues For PLC Receiving" has been configured multiple times

Messages of the number of specified by "Number of Multi-Transaction Queues For PLC Receiving" are interleaved (accumulated). Interleaved messages are processed after transactions being processed are completed.

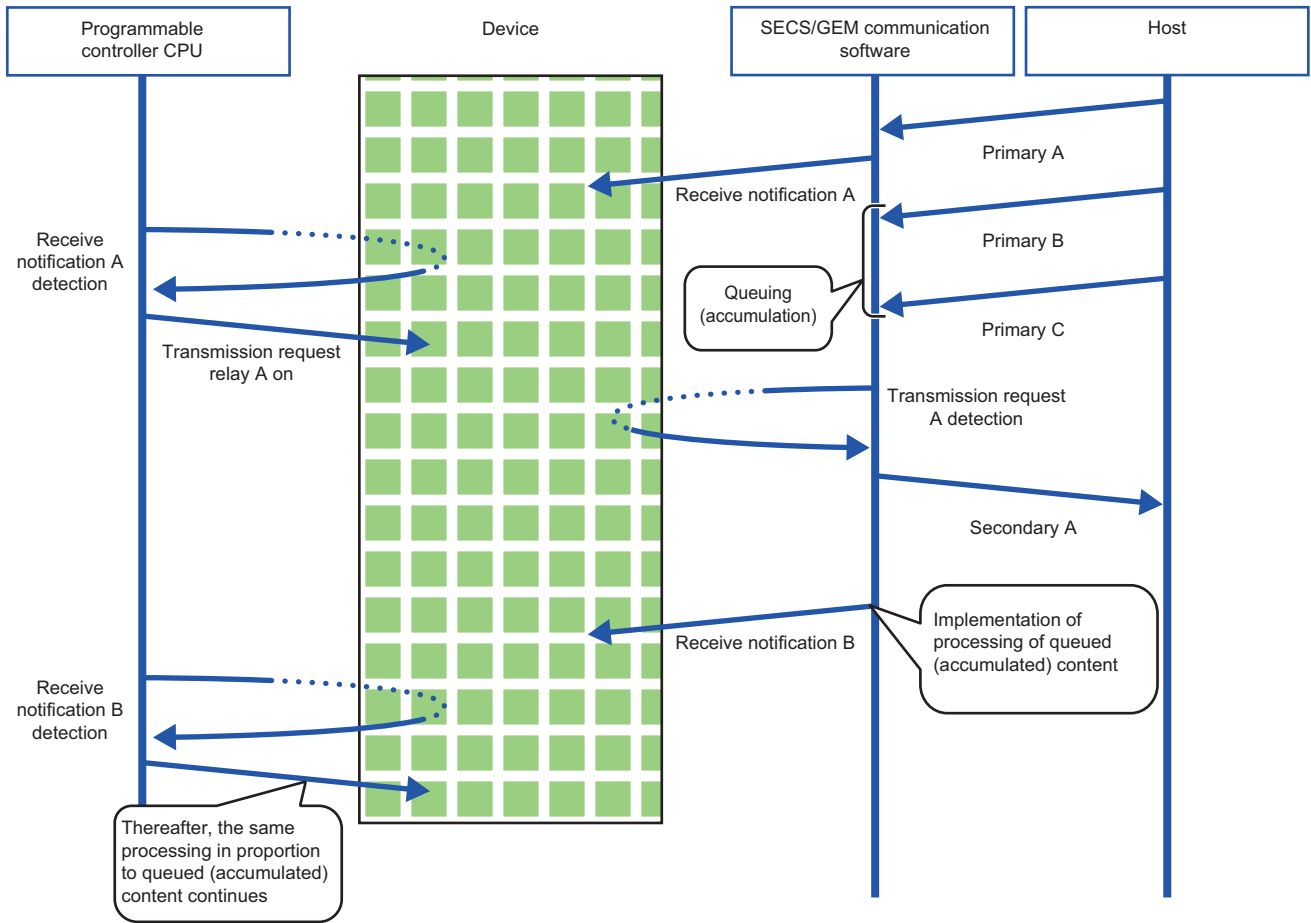

Precautions

When the Number of Multi-Transaction Queues For PLC Receiving becomes full, messages that come later are aborted.

■ Operation during sending when multiple items are set for "Number Of Transaction Queues For PLC Transmission"

Messages of the number of specified by "Number of Transaction Queues For PLC Transaction" are interleaved (accumulated).

In the case of interleaved messages, the number configured by "Number of Multi-Transaction Queues For PLC Transaction" for each transaction is sent. Messages are sent one by one when "Number of Multi-Transaction Queues For PLC Transaction" has been configured to "1".)

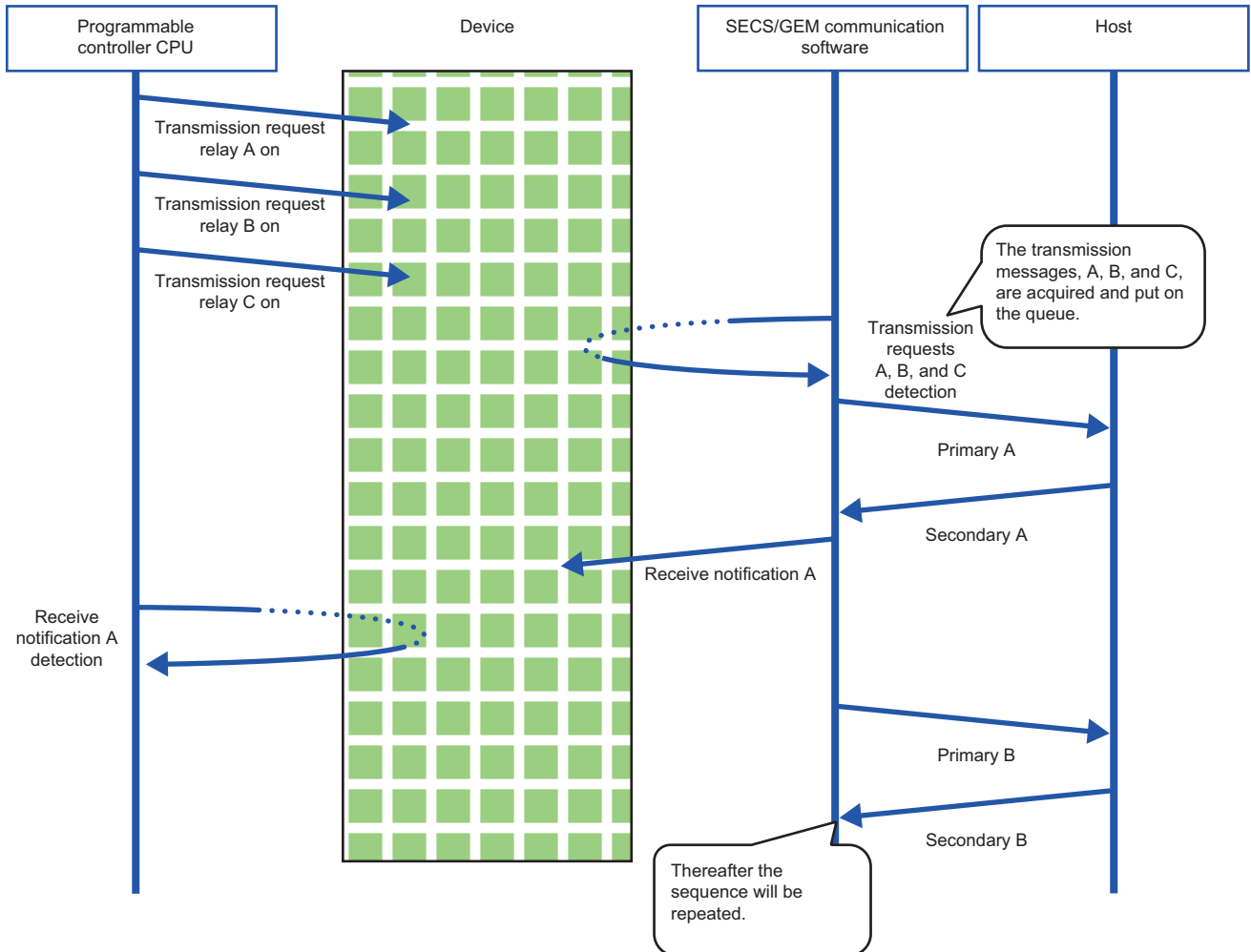

Precautions

If the Number of Transaction Queues For PLC Transaction becomes full, sending fails and later messages are discarded.

■ Operation during reception when multiple items are set for "Number Of Transaction Queues For PLC Transmission"

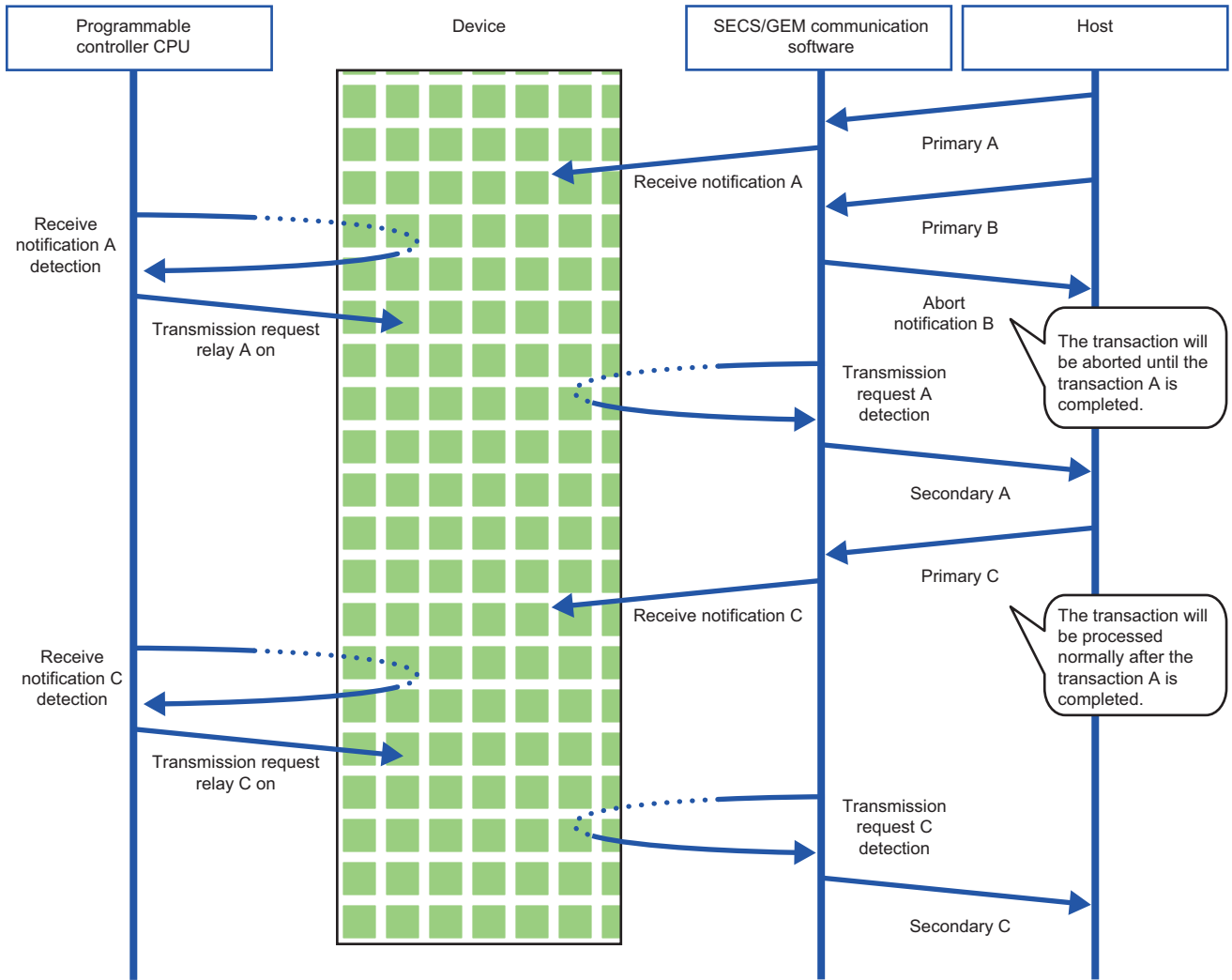

Control 2

Series	SECS/GEM communication software		
	Non-GEM version	GEM version	GEM advanced version
MELSEC-Q series	<input type="radio"/>	<input type="radio"/>	<input type="radio"/>
MELSEC iQ-R series	<input type="radio"/>	<input type="radio"/>	<input type="radio"/>



Window

 [Setting]⇒[Option Setting]⇒[Control 2] tab

■MELSEC-Q series

■MELSEC iQ-R series

Displayed items

Item	Description	
Shared Memory Synch. Waiting Timer ^{*1}	<p>Configure the shared memory synchronization adjustment timer.</p> <p>Sometimes adjustments are required when shared memory is assigned to a trigger relay.</p> <p>When shared memory is assigned, the SECS/GEM communication software controls the relay by handshaking and then verifies that the prescribed relay status has been updated by a refresh of the multiple CPUs in accordance with the value of this simultaneous adjustment timer.</p> <p>When ladder program processing requires time, a change in the relay status is not detected even if the SECS/GEM communication software is delayed by the configured time, resulting in status inconsistency.</p> <p>At this time, adjust the timer value, taking into consideration ladder program scan processing.</p>	
Change the C Controller module time by S2F31/S2F18 reception	<p>Select this checkbox to configure the time of the MELSEC-Q series SECS/GEM communication software pre-installed model module when an S2F31 or S2F18 was received.</p> <p>The SECS/GEM communication software uses an S2F18 or S2F31 for reserved transactions and, upon receipt of time data from the host, replaces the time of the MELSEC-Q series SECS/GEM communication software pre-installed model module.</p> <p>However, it synchronizes with the time of CPU No. 1 automatically when Multiple CPU Setting has been configured.</p> <p>For details on S2F18 and S2F31 transactions, see the following reference.</p> <p> Page 268 List of reserved transactions and format</p> <p>The SECS/GEM communication software uses the SECS/GEM communication software pre-installed model module time in log data. As a result, when the logs are viewed, the order of the data may appear different from actual data transmission and reception, in accordance with the time changes.</p>	
Change the C intelligent function module time by S2F31/S2F18 reception	<p>The MELSEC iQ-R series SECS/GEM communication software pre-installed model module does not have a function to replace the time of the module.</p> <p>The SECS/GEM communication software treats S2F18 and S2F31 as reserve transactions.</p> <p>For details on S2F18 and S2F31 transactions, see the following reference.</p> <p> Page 268 List of reserved transactions and format</p>	
Queue Clear Settings	T3 timeout	Select this checkbox to clear the messages accumulated in the SECS/GEM communication software sending queue when a T3 timeout has occurred.
	T9 timeout	Select this checkbox to clear the messages accumulated in the SECS/GEM communication software sending queue when a T9 timeout has occurred.
	Dialog Violation	Select this checkbox to clear the messages accumulated in the SECS/GEM communication software sending queue when a dialog violation has occurred.
HOST/GATEWAY mode settings ^{*2}	HOST mode	<p>Select this checkbox to use the SECS/GEM communication software as a host to communicate with the equipment.</p> <p>When the SECS/GEM communication software will be installed on the equipment, clear the checkboxes of HOST mode and GATEWAY mode.</p>
	GATEWAY mode	<p>Select this checkbox to use the SECS/GEM communication software as a gateway to intermediate messages.</p> <p>When the SECS/GEM communication software will be installed on the equipment, clear the checkboxes of HOST mode and GATEWAY mode.</p>
Number of Transaction Queues for PLC Transmission	Queue Counts	If a register is assigned in this setting, the number of messages currently in queue is output to the specified register.
	Maximum Queue Counts	When the checkbox of "Maximum Queue Counts" is selected, a value set for "Number Of Transaction Queues For PLC Transmission" is stored in the configured register No. + 1 word.
Communication Interruption Time ^{*2}	Communication disconnection time storage format	<p>Configure the data type when storing the Communication disconnection occurrence time.</p> <p>If "DATE-Q" or "DATE-A" is selected for the storage format, the time is stored in binary.</p> <p>For an example of a value stored to a register, see the following reference.</p> <p> Page 79 Register storage formats</p>
	Communication disconnection occurrence time	<p>Configure the register to store the time when the communication state changed from "COMMUNICATING" to "NOT COMMUNICATING".</p> <p>The updating of this register is synchronized with the switching of the CA state notification relay and Communication established relay from ON to OFF.</p> <p>This is normally when a line disconnection detection and Communication failure (sending error) occur, but "T3 timeout" and "Set communication as disconnected by receipt of an abort of message subject to spooling" may also be included in the conditions depending on the settings of the [Control 1] tab.</p>
File Output Stop setting	File Output Stop	<p>File output can be stopped to prevent file corruption before a reset of a SECS/GEM communication software pre-installed model module.</p> <p>When the file output stop relay is ON, it operates as though the Mode switch of the SECS/GEM communication software pre-installed model module is OFF.</p>

*1 Can be configured for only the MELSEC-Q series SECS/GEM communication software pre-installed model module.

*2 Can be configured only by a non-GEM version.

HOST/GATEWAY mode operations

Name	Operation
HOST mode setting	<ul style="list-style-type: none"> • S9 messages are not sent automatically. However, there is notification when there is a setting of the S9 sending notification relay. • During S9 message receipt, messages are not discarded. • The spool is normally disabled.
GATEWAY mode setting	<ul style="list-style-type: none"> • No restrictions are applied to the transmission of messages, even in the case of communication disconnection or an offline state. • The spool is normally disabled. • Time is synchronized by sending of S2F31 and S2F18.

Register storage formats

The following table shows examples of the communication disconnection occurrence times stored to registers.

- "Communication disconnection occurrence time" is configured to D201
- Communication disconnection occurrence time is "2009/12/15 9:46:15.195"

Register No.	DATE-Q	DATE-A	ASCII 12	ASCII 14	ASCII 16
D201	2009 (Year)	9 (Year)	"09" (Year)	"20" (Year)	"20" (Year)
D202	12 (Month)	12 (Month)	"12" (Month)	"09" (Year)	"09" (Year)
D203	15 (Day)	15 (Day)	"15" (Day)	"12" (Month)	"12" (Month)
D204	9 (Hour)	9 (Hour)	"09" (Hour)	"15" (Day)	"15" (Day)
D205	46 (Minute)	46 (Minute)	"46" (Minute)	"09" (Hour)	"09" (Hour)
D206	15 (Second)	15 (Second)	"15" (Second)	"46" (Minute)	"46" (Minute)
D207	2 (Day of week)	2 (Day of week)	00(NULL)	"15" (Second)	"15" (Second)
D208	Not used	Not used	Not used	00(NULL)	"19"(1/100)
D209	Not used	Not used	Not used	Not used	00(NULL)

Retry setting

Series	SECS/GEM communication software		
	Non-GEM version	GEM version	GEM advanced version
MELSEC-Q series	○	—	—
MELSEC iQ-R series	—	—	—

Window

[Setting]⇒[Option Setting]⇒[Retry Setting] tab

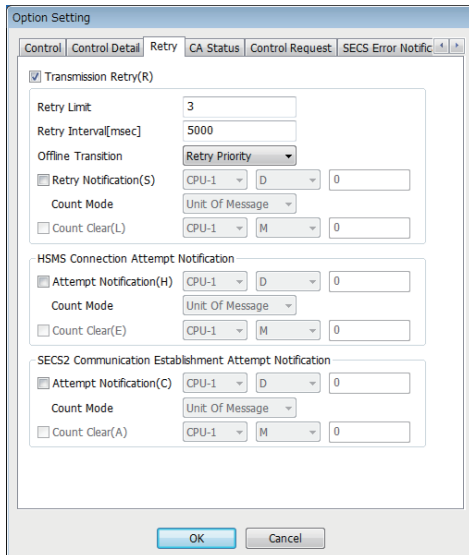

Displayed items

Item	Description
Sending retry function	<p>—</p> <p>Select this checkbox to enable the SECS/GEM communication software function to resend automatically when an equipment-issued transaction has failed. A retry occurs when a response timeout (T3 timeout) or sending error of the communication protocol results. A new transaction ID of the retry message is assigned.</p>
Retry upper limit	<p>Configure the number of retries. When this number of retries is attempted, and the final message results in a response timeout, it is treated as a T3 timeout error, S9 and F9 are sent, and spooling starts. The initial message is not included in the count. For more details, see the following reference. ☞ Page 81 Retry operations during T3 timeouts</p>
Retry interval	<p>Configure the retry interval in milliseconds. The default is 5000 ms (5 seconds).</p>
Offline transition	<p>Configure whether to cancel retrying and transfer to an offline state (retry cancel) or transfer to an offline state after retry completion when an "Offline" control request occurred and an offline transition occurred due to a ladder program during message retry.</p>
Number of retries notification	<p>Configure the register to store the number of retries performed.</p>
Counting method	<p>Select the counting method for the number of retries.</p> <ul style="list-style-type: none"> When "By message" was selected for the counting method, the number of message retries during the current retry attempt is stored in the number of retries notification. If the transaction was successfully while retrying, this is initialized to 0. When the retry limit was reached, it is initialized to 0 when the next message sent successfully. Normally, it is initialized to 0 at the sending of S9 and F9. When "Accumulate" was selected as the counting method, the number of retries to be added with each retry occurrence is stored in the number of retries notification. When the value reaches 65535, counting stops.
Count clearing	<p>Configure the trigger to initialize the value of the number of sending retries notification register to "0" at the arbitrary timing of the programmable controller CPU. After initialization is run, this trigger is switched OFF by the SECS/GEM communication software. Use this mainly to clear the accumulated number.</p>

Item		Description
Number of HSMS connection attempts setting	Number of HSMS connection attempts	Configure the register to store the number of times Select.req was sent from a line disconnection state.
	Counting method	Select the counting method for the number of HSMS connection attempts. • When "By message" was selected for the counting method, the number of times Select.req was sent is stored in the HSMS connection attempts notification register. Initialized to 0 by a Selected state transition. • When "Accumulate" was selected for the counting method, the number of times Select.req was sent is stored in the HSMS connection attempts notification register. When the value reaches 65535, counting stops.
	Count clearing	Configure the trigger to initialize the value of the number of HSMS connection attempts notification register to "0" at the arbitrary timing of the programmable controller CPU. After initialization is run, this trigger is switched OFF by the SECS/GEM communication software. Use this mainly to clear the accumulated number.
Number of SECS-2 communication establishment attempts notification setting	Number of SECS-2 communication establishment attempts notification	Configure the register to store the number of times S1 and F13 were sent from a communication disconnection state.
	Counting method	Select the counting method for the number of SECS-2 communication establishment attempts. • When "By message" was selected for the counting method, the number of times an S1F13 was sent from a communication suspended state is stored in the SECS-2 communication establishment attempt notification register. Initialized to 0 by a communication execution state transition. • When "Accumulate" was selected for the counting method, the number of times an S1F13 was sent from a communication suspended state is stored in the SECS-2 communication establishment attempt notification register. When the value reaches 65535, counting stops. Note that the number of message retries is not included in this count.
	Count clearing	Configure the trigger to initialize the value of the number of SECS-2 communication establishment attempts notification register to "0" at the arbitrary timing of the programmable controller CPU. After initialization is run, this trigger is switched OFF by the SECS/GEM communication software. Use this mainly to clear the accumulated number.

Retry operations during T3 timeouts

The following diagram is an example of retry operations during T3 timeouts

Ex.

When "3" was configured, the 1st normal-send plus 3 retry-sends equals 4 sends.

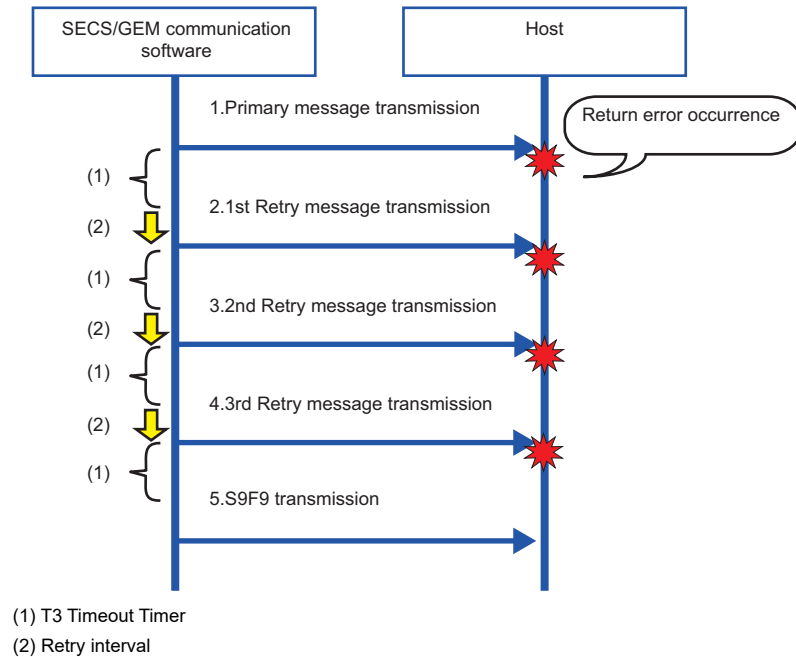

CA Status

Series	SECS/GEM communication software		
	Non-GEM version	GEM version	GEM advanced version
MELSEC-Q series	<input type="radio"/>	<input type="radio"/>	<input type="radio"/>
MELSEC iQ-R series	<input type="radio"/>	<input type="radio"/>	<input type="radio"/>

Window

 [Setting]⇒[Option Setting]⇒[CA Status] tab

■MELSEC-Q series

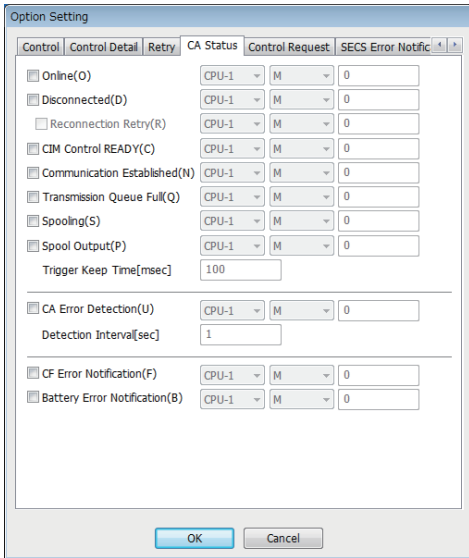

Option Setting

Control | Control Detail | Retry | CA Status | Control Request | SECS Error Notific

Online(O) CPU-1 M 0

Disconnected(D) CPU-1 M 0

Reconnection Retry(R) CPU-1 M 0

CIM Control READY(C) CPU-1 M 0

Communication Established(N) CPU-1 M 0

Transmission Queue Full(Q) CPU-1 M 0

Spooling(S) CPU-1 M 0

Spool Output(P) CPU-1 M 0

Trigger Keep Time[msec] 100

CA Error Detection(U) CPU-1 M 0

Detection Interval[sec] 1

CF Error Notification(F) CPU-1 M 0

Battery Error Notification(B) CPU-1 M 0

OK Cancel

■MELSEC iQ-R series

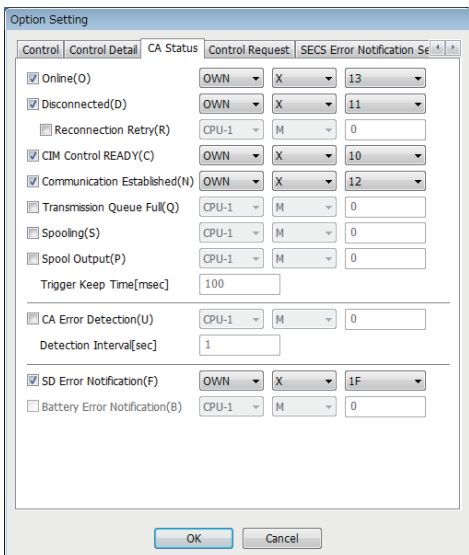

Option Setting

Control | Control Detail | CA Status | Control Request | SECS Error Notification Se

Online(O) OWN X 13

Disconnected(D) OWN X 11

Reconnection Retry(R) CPU-1 M 0

CIM Control READY(C) OWN X 10

Communication Established(N) OWN X 12

Transmission Queue Full(Q) CPU-1 M 0

Spooling(S) CPU-1 M 0

Spool Output(P) CPU-1 M 0

Trigger Keep Time[msec] 100

CA Error Detection(U) CPU-1 M 0

Detection Interval[sec] 1

SD Error Notification(F) OWN X 1F

Battery Error Notification(B) CPU-1 M 0

OK Cancel

Displayed items

Item	Description
Online	Configure the relay to notify the programmable controller CPU when an online status (S1F1→S1F2) was established between the host and equipment. S1F1/F2 is treated as a special transaction.
Disconnected	— Configure the relay to notify the programmable controller CPU when the line was disconnected between the host and equipment. The relay is ON immediately after start-up of the SECS/GEM communication software. In the case of HSMS, the relay is turned OFF when TCP/IP connection is completed, and Select.req⇒Select.rsp was received. For SECS-I communication, the relay remains OFF after the SECS/GEM communication software opens the port immediately after start-up. The relay cannot be turned ON even if the line was disconnected. (A T2 protocol timeout error occurs when sending data.) Do not use the relay as a disconnection detection condition of the Programmable Controller CPU.
	Reconnection Retry Configure the relay to notify the programmable controller CPU during a line reconnection when the line with the host was disconnected. The reconnection retry relay is switched OFF when reconnection was completed or the Maximum Number of Retries after Line Disconnection was exceeded. For configuration of the Maximum Number of Retries after Line Disconnection, see the following reference. ☞ Page 69 Control 1 To determine whether communication retries are being performed, see the following reference. ☞ Page 84 Reconnection Retrying
CIM Control READY	Configure the relay to notify the programmable controller CPU when the SECS/GEM communication software starts completely and enters a controllable state. Note that the processing should be programmed so that the programmable controller CPU does not detect errors before the CIM Control READY relay is turned ON.
Communication Established	Configure the relay to notify the programmable controller CPU when communication (S1F13→S1F14) was established between the host and equipment. Note that the determination of communication establishment depends on the setting that determines whether S1F13 is used for the communication establishment sequence. S1F13/F14 is treated as a special transaction. For setting content, see the following reference. ☞ Page 69 Control 1
Transmission Queue Full	Configure the relay to notify the programmable controller CPU when the sending message queue from the SECS/GEM communication software reaches a value set for "Number Of Transaction Queues For PLC Transmission". The SECS/GEM communication software performs sending processing until the sending queue is full. After that, however, even when sending is requested, sending fails, and the subsequent messages are not sent. Perform sending processing after clearing the sending queue full status.
Spooling ^{*1}	Configure the relay to notify the programmable controller CPU when messages subject to spooling have been spooled. For details on the spooling function, see the following reference. ☞ Page 106 Spool Definition Settings
Spool Outputting ^{*1}	— Trigger Keep Time ^{*1} Configure the relay to notify the programmable controller CPU when the SECS/GEM communication software is sending messages subject to spooling automatically. If there is no spool data when an S6F23 was received from the host, this relay is ON only for the time configured by the trigger keep time. For details on the spooling function, see the following reference. ☞ Page 106 Spool Definition Settings
CA Error Detection	— Detection period Configure the relay to verify that the SECS/GEM communication software application is running from the ladder program. The SECS/GEM communication software follows the configured detection period and turns OFF the CA Error Detection relay.
CF Error Detection ^{*2}	Configure the relay to notify of any error detection when the SECS/GEM communication software accessed the memory card.
SD Error Detection ^{*3}	
Battery Error Detection ^{*2}	Configure the relay to notify the programmable controller CPU that the built-in battery of the MELSEC-Q series SECS/GEM communication software pre-installed model module has died.

*1 Can be configured only by a non-GEM version.

*2 Can be configured for only the MELSEC-Q series SECS/GEM communication software pre-installed model module.

*3 Can be configured for only the MELSEC iQ-R series SECS/GEM communication software pre-installed model module.

Reconnection Retrying

Refer to the following table to determine whether a connection retry is being performed by combining the Disconnected relay and Reconnection retrying relay.

Disconnected relay	Connection retry relay	Status
ON	ON	Reconnection Retry
ON	OFF	Connection retry end

Point

The "Online" relay and "Communication established" relay are used to notify the programmable controller CPU that the exchange of some specific transaction was performed.

Such transactions are treated as special transactions of the SECS/GEM communication software.

For details on special transactions, see the following reference.

 Page 269 Special Transactions

Precautions

■ Setting an X device for each relay

It is possible to configure "OWN (host station)" as the CPU number and device to "X" when the MELSEC iQ-R series SECS/GEM communication software pre-installed model module is being used.

Control Request

Series	SECS/GEM communication software		
	Non-GEM version	GEM version	GEM advanced version
MELSEC-Q series	<input type="radio"/>	<input type="radio"/>	<input type="radio"/>
MELSEC iQ-R series	<input type="radio"/>	<input type="radio"/>	<input type="radio"/>

Window

 [Setting]⇒[Option Setting]⇒[Control Request] tab

■MELSEC-Q series

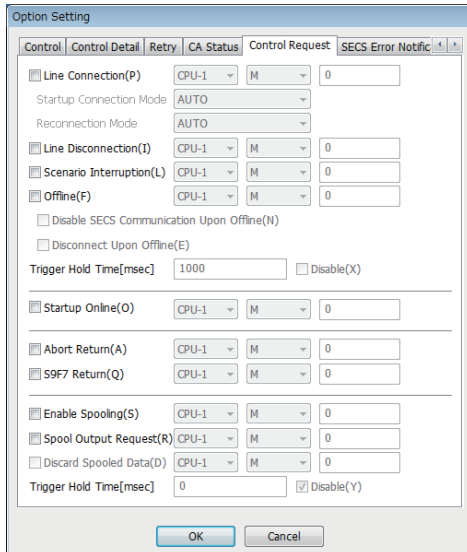

Option Setting

Control | Control Detail | Retry | CA Status | Control Request | SECS Error Notific...

Line Connection(P) CPU-1 M 0
Startup Connection Mode AUTO
Reconnection Mode AUTO

Line Disconnection(I) CPU-1 M 0

Scenario Interruption(L) CPU-1 M 0

Offline(F) CPU-1 M 0
 Disable SECS Communication Upon Offline(N)
 Disconnect Upon Offline(E)

Trigger Hold Time[msec] 1000 Disable(X)

Startup Online(O) CPU-1 M 0

Abort Return(A) CPU-1 M 0

S9F7 Return(Q) CPU-1 M 0

Enable Spooling(S) CPU-1 M 0

Spool Output Request(R) CPU-1 M 0

Discard Spooled Data(D) CPU-1 M 0

Trigger Hold Time[msec] 0 Disable(Y)

OK Cancel

■MELSEC iQ-R series

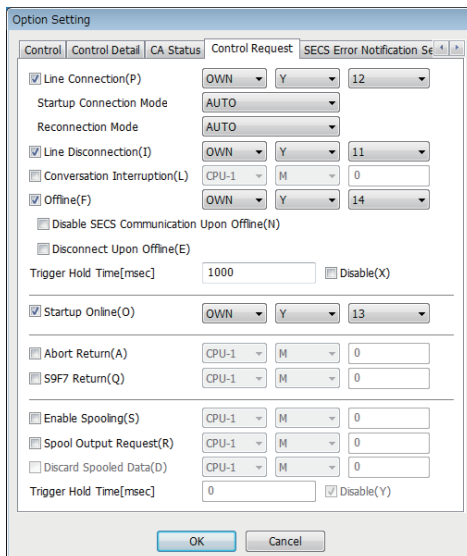

Option Setting

Control | Control Detail | CA Status | Control Request | SECS Error Notification Se...

Line Connection(P) OWN Y 12
Startup Connection Mode AUTO
Reconnection Mode AUTO

Line Disconnection(I) OWN Y 11

Conversation Interruption(L) CPU-1 M 0

Offline(F) OWN Y 14
 Disable SECS Communication Upon Offline(N)
 Disconnect Upon Offline(E)

Trigger Hold Time[msec] 1000 Disable(X)

Startup Online(O) OWN Y 13

Abort Return(A) CPU-1 M 0

S9F7 Return(Q) CPU-1 M 0

Enable Spooling(S) CPU-1 M 0

Spool Output Request(R) CPU-1 M 0





Discard Spooled Data(D) CPU-1 M 0

Trigger Hold Time[msec] 0 Disable(Y)

OK Cancel

Displayed items

Item	Description
Line Connection	<p>—</p> <p>Configure the line connection relay. In case of an HSMS connection, the line is connected, and a Select request is sent by the line connection relay trigger. In case of an SECS-I connection, the port is opened. The mode can be configured to specify an automatic connection attempt (AUTO) or a connection attempt based on a request from the programmable controller CPU (MANUAL) during startup and upon line disconnection detection. If the startup connection mode and the reconnection mode were configured to "MANUAL", the line connection relay only is the connection method.</p>
Startup Connection Mode	<p>Select the mode during start-up.</p> <ul style="list-style-type: none"> • AUTO After SECS/GEM communication software start-up, TCP/IP and HSMS connections are attempted automatically. • MANUAL After SECS/GEM communication software start-up, TCP/IP and HSMS connections are not attempted until there is a request by the line connection trigger.
Reconnection Mode	<p>Select the mode during disconnection detection.</p> <ul style="list-style-type: none"> • AUTO When a line disconnection was detected, such as a T6 Timer timeout, TCP/IP and HSMS connections are attempted automatically. If the disconnection was intentionally triggered by the disconnection trigger, TCP/IP and HSMS connections are not attempted until there is a request by the line connection trigger. • MANUAL Even when a line disconnection was detected, TCP/IP and HSMS connections are not attempted until there is a request by the line connection trigger.
Line Disconnection	<p>Configure the line disconnection relay. In case of an HSMS connection, the line is disconnected by the line connection relay trigger. In case of an SECS-I connection, the port is closed.</p>
Scenario Interruption ^{*1}	<p>Configure the scenario interruption relay. Scenario execution is interrupted by the trigger of the scenario interruption relay. T9 dialog interruption is also possible.</p>
Dialog Interruption ^{*2}	<p>Configure the dialog interruption relay. Dialog execution is interrupted by the trigger of the dialog interruption relay. T9 dialog interruption is also possible.</p>
Offline	<p>—</p> <p>Configure the offline relay. An offline transition is requested of the SECS/GEM communication software by the offline relay trigger. When the "Switch Into Offline Status Upon Disconnection" checkbox is cleared at the [Control 1] tab, the SECS/GEM communication software does not transition to offline other than by this request. Nothing occurs when this request was detected in an already offline state. The SECS/GEM communication software completes the transition to the offline state by this request. When there is an offline procedure, have it complete before this relay is switched ON. However, it is not necessary to wait for sending completion of an offline report message or secondary message reception. The SECS/GEM communication software switches OFF the offline relay immediately after detecting that the offline relay is ON. The relay is switched OFF immediately even when there is already an offline state. Completion of offline transition is checked by the "Online" relay.</p>
SECS communication is disabled by an offline transition ^{*3}	<p>Select this checkbox to configure a communication-disabled state following the offline transfer. In a communication-disabled state, messages other than S1F13/F14 received from the host are discarded. Furthermore, sending requests other than S1F13/14 are canceled.</p>
Disconnect Line By Offline Transition ^{*3}	<p>Select this checkbox to close the TCP/IP port after the Separate procedure following the offline transition. The reconnection procedure is not performed automatically. To start reconnection, use the line connection relay.</p>
Trigger Hold Time	<p>The times that the Line Connection, Line Disconnection, Scenario Interruption, Dialog Interruption, and Offline relays are held are monitored, and triggers are detected. If the "Not Monitored" checkbox is selected, trigger processing is carried out without hold monitoring.</p>
Online Start ^{*3}	<p>Configure the online-start relay to instruct a start in an online state. When you want to return to an online state after communication establishment (S1F13→F14) without performing an online transfer (S1F1→F2) because, for example, a reset was performed while maintaining an online state, set the online start relay to ON, and then start the SECS/GEM communication software. Use the programmable controller CPU to determine advisability of the online start.</p>

Item	Description
Abort Return	<p>Configure the abort return relay.</p> <p>While the abort return relay is ON, an abort message is returned, instead of a secondary message, after a primary message is received.</p> <p>For more details, see the following reference.</p> <p> Page 88 Operations of Abort Return and S9F7 Return</p>
S9F7 Return	<p>Configure the S9F7 return relay.</p> <p>While the S9F7 return relay is ON, an S9F7 message is returned, instead of a secondary message, after a primary message is received.</p> <p>For more details, see the following reference.</p> <p> Page 88 Operations of Abort Return and S9F7 Return</p>
Enable Spooling ^{*3}	<p>Configure in the Enable spooling relay to enable the spooling function.</p> <p>When the Enable spooling relay has been disabled, the spooling function is always available.</p> <p>If this is OFF during spooling, the Enable spooling relay to be defined at the [CA Status] tab is also OFF. However, all messages being spooled are sent, even after an operation to switch the Enable spooling flag from ON to OFF while spool data is being output.</p> <p>Regarding the spooling relay, see the following reference.</p> <p> Page 82 CA Status</p>
Spool Output Request ^{*3}	<p>Configure the spool output request relay to request an output of the spool (transfer or discarding).</p> <p>The SECS/GEM communication software outputs the spool upon receipt of the S6F23 (Spooled data request) from the host.</p> <p>This operation complies with GEM standards.</p> <p>However, this relay is used, and the spool is output when the spool request message is not used due to communication standards or the format of the spool request message differs from the standards.</p> <p>Turn ON the relay from a ladder program to start transfer of the spool. The SECS/GEM communication software turns OFF this relay either after all transfers are completed or the transfer process ends with an error. To determine whether all transfers were completed, check "No. of Spool Items".</p> <p>For "No. of Spool Items", see the following reference.</p> <p> Page 106 Spool Definition Settings</p> <p>When the spool is to be discarded, with the spool data disposal relay ON, turn ON the spool output request relay.</p>
Spool Data Disposal ^{*3}	<p>Configure the spool data disposal relay to discard the spool data and initialize it.</p> <p>This relay does not function on its own. This relay is referenced when the Enable spooling relay is switched ON or OFF or when the Spool output request relay is controlled to ON.</p> <p>After the spool data is discarded, the SECS/GEM communication software turns OFF the relay.</p> <p>To dispose of spool data, it is necessary for the programmable controller CPU to turn ON the relay before manipulating the spool enabled flag.</p>
Trigger Hold Time ^{*3}	<p>The times that the Enable Spooling, Spool Output Request, and Spool Data Disposal relays are held are monitored, and triggers are detected.</p> <p>If the "Not Monitored" checkbox is selected, trigger processing is carried out without hold monitoring.</p>

*1 Can be configured for only the MELSEC-Q series SECS/GEM communication software pre-installed model module.

*2 Can be configured for only the MELSEC iQ-R series SECS/GEM communication software pre-installed model module.

*3 Can be configured only by a non-GEM version.

Operations of Abort Return and S9F7 Return

Use to send an abort or S9F7 in accordance with the data content or return an abort or S9F7 when some processing is being carried out at the equipment after a primary message was received.

When a primary message was received, and a secondary message is to be sent, the SECS/GEM communication software refers to the status of this relay. If the relay is ON, it sends an abort or S9F7 message. If the relay is OFF, the prescribed secondary message is sent. Accordingly, it is necessary to carry out a sending request of a secondary message as usual, even when an abort or S9F7 is to be sent.

Furthermore, when Abort return or S9F7 return has been switched ON, the SECS/GEM communication software does not switch OFF the abort relay but switches OFF the S9F7 relay.

That is why the setting of Abort return is enabled when a transaction other than a special transaction is aborted due to processing being performed at the equipment.

Precautions

■Setting a Y device for each relay

It is possible to configure "OWN (host station)" as the CPU number and device to "Y" when the MELSEC iQ-R series SECS/GEM communication software pre-installed model module is being used.

When "Y" has been configured for the device, the SECS/GEM communication software does not switch the output signal (Y) from ON to OFF.

To enable the output signal again, switch the output signal one time from ON to OFF, and then from OFF to ON.

■Online Start Relay

- For the online start relay, configure the link relay of B devices, etc., and the M device specified to automatic refresh from the X device that directly inputs the equipment switch.
- Before CIM control READY is switched ON, the SECS/GEM communication software references the online start relay state. If it is ON, an online start is performed. After CIM control READY turns ON, an online start is not performed even when the online start relay is controlled.

■Abort Return Relay and S9F7 Return Relay

Regardless of the setting content, the receipt of primary messages is carried out by normal operation.

It is not the case that an automatic return is performed for primary messages while these relays are ON.

■Spool Control

Spool data is saved to the memory card in the SECS/GEM communication software pre-installed model module.

Configure so that the Enable spooling relay is not switched frequently during queuing, spool data output, and other spool processing.

About forced offline during emergencies

When the offline relay was switched ON, any unsent messages in the sending queue are discarded.

When there is an emergency offline transition after an offline report message was sent, the format specified "OFFLINE" function is used.

Ex.

When multiple messages that have accumulated in the sending queue are discarded, an offline report only is sent, and there is a transition to offline

Setting: configure the S6F101 format specification to "OFFLINE"

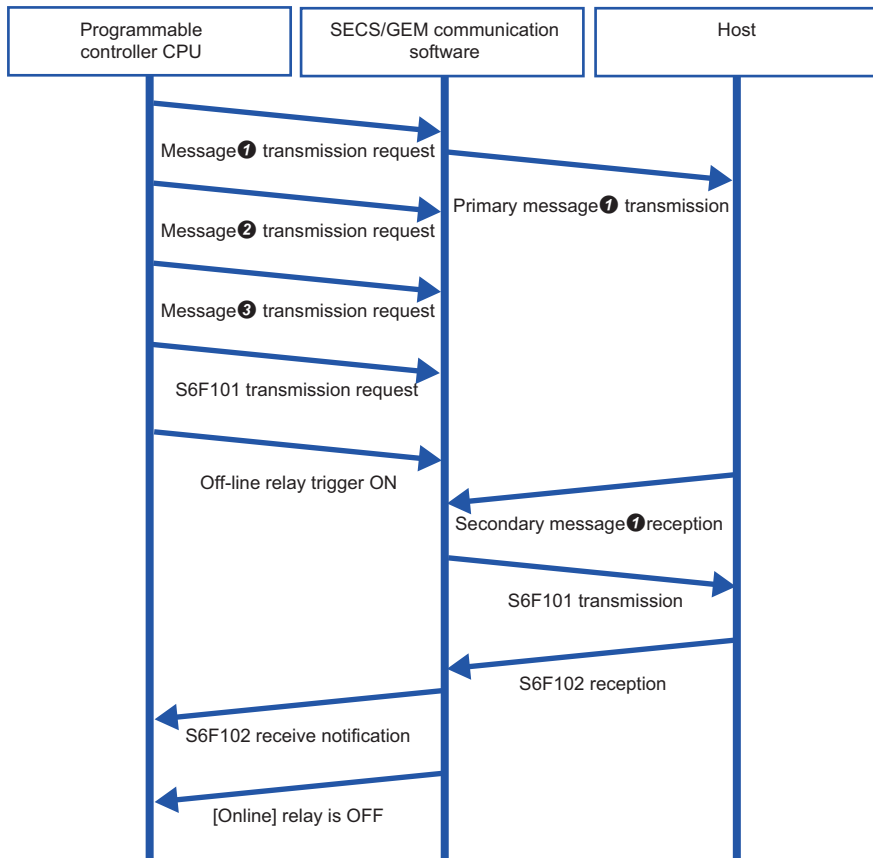

Same sequence applies for disconnection.

In the example above, the S6F101 "Trigger Hold Time" is configured to a value less than the offline "Trigger Hold Time". This is the setting to send S6F101 first when the S6F101 sending request trigger and offline trigger were switched ON simultaneously.

S6F101 is not sent until a secondary message of message 1 is received or a T3 timeout occurs. This function sends offline reports by priority for queued messages 2 and 3.

It does not prioritize and send just by a sending request of S6F101. Switching ON the offline trigger relay prioritizes and sends S6F101.

Messages 2 and 3 are discarded. However, the offline spool is configured to enabled, and messages subject to spooling are spooled.

When message 1 resulted in a T3 timeout, the operation differs by the retry setting. When the retry function is disabled or "Retry cancel" has been selected for offline transition, S6F101 is sent immediately. When "Retry priority" has been selected for offline transition, S6F101 is not sent until the retries are complete.

SECS Error Notification Setting

Series	SECS/GEM communication software		
	Non-GEM version	GEM version	GEM advanced version
MELSEC-Q series	<input type="radio"/>	<input type="radio"/>	<input type="radio"/>
MELSEC iQ-R series	<input type="radio"/>	<input type="radio"/>	<input type="radio"/>

Window

 [Setting]⇒[Option Setting]⇒[SECS Error Notification Setting] tab

■MELSEC-Q series

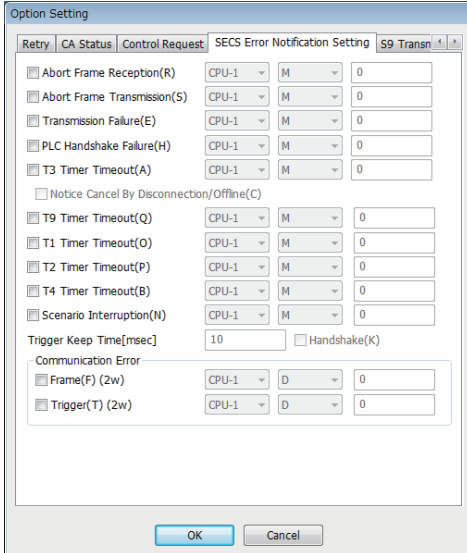

Option Setting

Retry | CA Status | Control Request | SECS Error Notification Setting | S9 Transn

Abort Frame Reception(R) CPU-1 M 0

Abort Frame Transmission(S) CPU-1 M 0

Transmission Failure(E) CPU-1 M 0

PLC Handshake Failure(H) CPU-1 M 0

T3 Timer Timeout(A) CPU-1 M 0

Notice Cancel By Disconnection/Offline(C)

T9 Timer Timeout(Q) CPU-1 M 0

T1 Timer Timeout(O) CPU-1 M 0

T2 Timer Timeout(P) CPU-1 M 0

T4 Timer Timeout(B) CPU-1 M 0

Scenario Interruption(N) CPU-1 M 0

Trigger Keep Time[msec] 10 Handshake(K)

Communication Error

Frame(F) (2w) CPU-1 D 0

Trigger(T) (2w) CPU-1 D 0

OK Cancel

■MELSEC iQ-R series

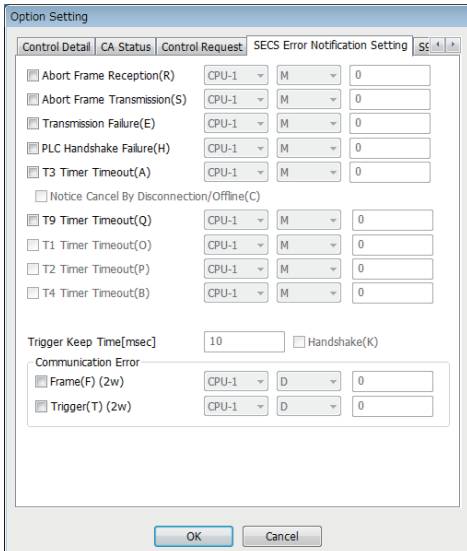

Option Setting

Control Detail | CA Status | Control Request | SECS Error Notification Setting | SC

Abort Frame Reception(R) CPU-1 M 0

Abort Frame Transmission(S) CPU-1 M 0

Transmission Failure(E) CPU-1 M 0

PLC Handshake Failure(H) CPU-1 M 0

T3 Timer Timeout(A) CPU-1 M 0

Notice Cancel By Disconnection/Offline(C)

T9 Timer Timeout(Q) CPU-1 M 0

T1 Timer Timeout(O) CPU-1 M 0

T2 Timer Timeout(P) CPU-1 M 0

T4 Timer Timeout(B) CPU-1 M 0

Trigger Keep Time[msec] 10 Handshake(K)



Communication Error

Frame(F) (2w) CPU-1 D 0

Trigger(T) (2w) CPU-1 D 0

OK Cancel

Displayed items

Item		Description
Abort Frame Reception		Configure the relay to notify the programmable controller CPU that the SECS/GEM communication software has received an abort message.
Abort Frame Transmission		Configure the relay to notify the programmable controller CPU that an abort message has been sent from the SECS/GEM communication software.
Sending Failure		Configure the relay to notify the programmable controller CPU that a data sending failure has occurred from the SECS/GEM communication software.
PLC Handshake Failure		Configure the relay to notify the programmable controller CPU that a handshake link with the programmable controller CPU failed during data receipt.
T3 Timer Timeout	—	Configure the relay to notify the programmable controller CPU that a response timeout occurred with the host.
	Notice Cancel By Disconnection/Offline	Configure the relay to notify the ladder program that the T3 timer is canceled for a transaction in a secondary message standby state due to a line disconnection or offline transition.
T9 Timer Timeout		Configure the relay to notify the programmable controller CPU that a timeout of T9 timer management occurred. For details on the T9 timer, see the following reference.  Page 52 Message Information
T1 Timer Timeout *1		Configure the relay to notify the programmable controller CPU that a timeout occurred between characters during reception from the host.
T2 Timer Timeout *1		Configure the relay to notify the programmable controller CPU that a protocol timeout occurred with the host.
T4 Timer Timeout *1		Configure the relay to notify the programmable controller CPU that a timeout occurred between message blocks during communication with the host.
Scenario Interruption *1		Configure the relay to notify the programmable controller CPU that the scenario execution was interrupted for some reason.
Trigger Keep Time		Configure the time to keep the configured notification relay.
Handshake		Select this checkbox to link handshakes between the programmable controller CPU and SECS/GEM communication software pre-installed model module with regard to SECS error notification. When this checkbox is selected, the specified relay is monitored for handshaking. Note that programmable controller CPU handshaking fails unless the specified relay is turned OFF by the programmable controller CPU within the time defined by the PLC response monitoring timer. For details on the PLC Response Monitoring Timer, see the following reference.  Page 69 Control 1
Communication error	Frame	Configure the register to write the number of the Stream Function that had a transmission error. The Stream number is written to the start register and the Function number is written into the next register.
	Trigger	Configure the register to write the type and number of the trigger relay that had a transmission error. The defined register is the first register, and the next register will also be used for registration. The device type is written to the start register and the device number is written into the next register. The following section shows the values to be written as device types. <ul style="list-style-type: none"> • Device type is M: 4 • Device type is B: 23

*1 Can be configured for only the MELSEC-Q series SECS/GEM communication software pre-installed model module.

S9 Transmission Notification

Series	SECS/GEM communication software		
	Non-GEM version	GEM version	GEM advanced version
MELSEC-Q series	<input type="radio"/>	<input type="radio"/>	<input type="radio"/>
MELSEC iQ-R series	<input type="radio"/>	<input type="radio"/>	<input type="radio"/>

Window

 [Setting]⇒[Option Setting]⇒[S9 Transmission Notification] tab

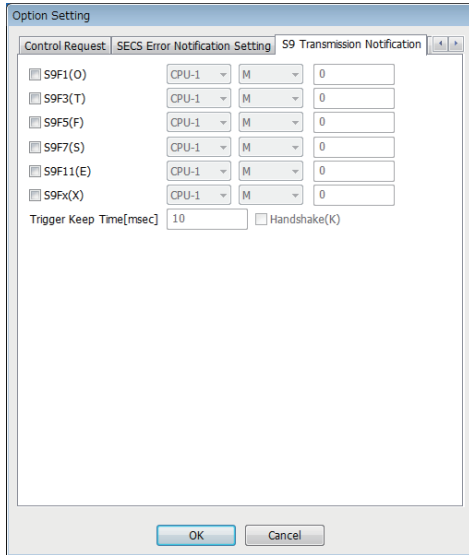

Displayed items

Item	Description
S9F1	Configure the register to notify the programmable controller CPU of sending of an undefined device ID message.
S9F3	Configure the register to notify the programmable controller CPU of sending of an undefined stream type message.
S9F5	Configure the register to notify the programmable controller CPU of sending of an undefined function type message.
S9F7	Configure the relay to notify the programmable controller CPU of sending of an incorrect data message.
S9F11	Configure the register to notify the programmable controller CPU of sending of a message with an incorrect data length.
S9Fx	Configure the relay to notify the programmable controller CPU when one of the following was sent: undefined device ID, undefined stream type, undefined function type, incorrect data, or message with incorrect data length. Operation of S9Fx relays is enabled regardless of the settings of the S9F1, S9F3, S9F5, S9F7, and S9F11 relays.
Trigger Keep Time	Configure the time to keep the notification relay.
Handshake	Select this checkbox to link handshakes between the SECS/GEM communication software pre-installed model module and programmable controller CPU with regard to S9 sending notification. If this checkbox is selected, S9 sending notifications are subject to handshake monitoring. Programmable controller CPU handshaking fails unless the notification relay is turned OFF by the programmable controller CPU within the time configured by the PLC Response Monitoring Timer. For details on the PLC Response Monitoring Timer, see the following reference. ☞ Page 69 Control 1 For details on programmable controller CPU handshake failures, see the following reference. ☞ Page 90 SECS Error Notification Setting

Precautions

- To send S9F7 when the data received from the host is illogical, enable the S9F7 return relay setting.
- Detect S9F9 by notification of the T3 timer timeout.
- Detect S9F13 by notification of the T9 timer timeout. Note that a message needs to be created by the programmable controller CPU since S9F13 is not automatically sent.

■When "S9Fx" and individual notification relays have been enabled

Ex.

When "S9Fx" and "S9F7" have been enabled

First, the S9Fx notification relay turns ON, and then the S9Fx notification relay is turned OFF by the programmable controller CPU. Next, the S9F7 notification relay turns ON, and then the S9F7 notification relay is turned OFF by the programmable controller CPU.

Console Setting

Series	SECS/GEM communication software		
	Non-GEM version	GEM version	GEM advanced version
MELSEC-Q series	<input type="radio"/>	<input type="radio"/>	<input type="radio"/>
MELSEC iQ-R series	—	—	—

Window

 [Setting]⇒[Option Setting]⇒[Console] tab

The screenshot shows the 'Option Setting' dialog box with the 'Console' tab selected. The 'Console Setting(U)' checkbox is checked. The 'User' field contains 'cseecs' and the 'Password' field contains 'cseecs'. The 'Serial Port' is set to 'COM1', 'Baud Rate' to '9600', 'Data Length' to '8B', 'Parity' to 'None', 'Stop Bit' to 'S1', and 'Flow Control' to 'None'. 'OK' and 'Cancel' buttons are at the bottom.

Displayed items

Item	Description
Console Setting	— Select this checkbox to acquire log data of the SECS/GEM communication software from the MELSEC-Q series SECS/GEM communication software pre-installed model module through serial communication. If this checkbox is selected, the console function always runs within the SECS/GEM communication software.
User	Configure the user name when logging into the console.
Password	Configure the password when logging into the console.
Serial port information	Configure the communication setting information for the console connection.
Baud Rate	
Data Length	
Parity	
Stop Bit	
Flow Control	

How to use the console

Use HyperTerminal, which is included with the Windows operating system, to connect the MELSEC-Q series SECS/GEM communication software pre-installed model module via serial communication.

HyperTerminal can be used with Windows 2000 and Windows XP.

■Start-up and login of HyperTerminal

1. Select Windows Start⇒[Programs]⇒[Accessories]⇒[Communication]⇒[HyperTerminal].
2. Enter the user name and password.

■Directory confirmation and manipulation

Use the following commands.

Command	Description
dir	Check a directory.
cd ***(directory name)	Move a directory.
mkdir ***(directory name)	Create a new directory.
rmdir ***(directory name)	Delete a directory.

■Downloading of files

Download a file from the current directory.

1. Enter the download command "down ***(filename)".
2. From the HyperTerminal menu, select [Transfer]⇒[Receive File].
3. Configure the file save destination, and configure the protocol to "Xmodem".
4. Click [Receive].

■Uploading of files

Upload a file to the current directory.

1. Enter the upload command "up ***(filename)".
2. From the HyperTerminal menu, select [Transfer]⇒[Send File].
3. Configure the file to be sent, and configure the protocol to "Xmodem".
4. Click the [Send] button.

■Browsing Help

Use the following commands.

Command	Description
help	Check the commands that can be used.

Version Information



Series	SECS/GEM communication software		
	Non-GEM version	GEM version	GEM advanced version
MELSEC-Q series	<input type="radio"/>	<input type="radio"/>	<input type="radio"/>
MELSEC iQ-R series	<input type="radio"/>	<input type="radio"/>	<input type="radio"/>

Window

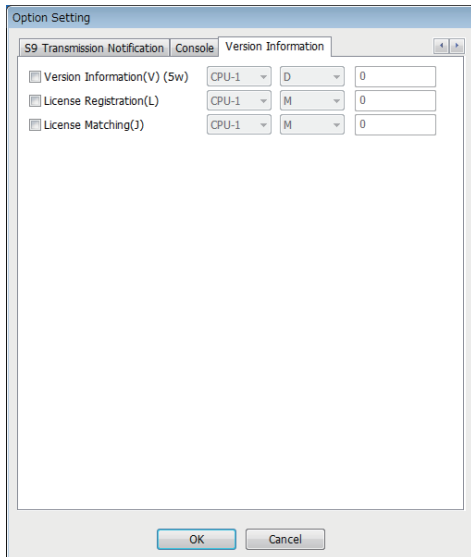
 [Setting]⇒[Option Setting]⇒[Version Information] tab



Displayed items

Item	Description
Version Information	Configure the register to store the version of the SECS/GEM communication software currently running. The version is stored as a character string in a register of 5 consecutive words starting from the configured register. The storage method is the same as the ASCII format item storage method. For the ASCII format item storage method, see the following reference.  Page 261 Data type conversion
License Registration	Configure the register to store the presence of the license file. If the license file is recognized, the SECS/GEM communication software turns ON the designated trigger. The activation destination of the license is the transfer destination (ROM or memory card) selected at the "Update Module" screen or "Update C intelligent module" screen. If the registration destination is different, the SECS/GEM communication software does not recognize the license file.
License Matching	Configure the relay to store the compliance regarding the content registered to the license file. When a genuine license is been registered, the SECS/GEM communication software turns ON the designated trigger. For license registration, see the following reference.  Page 27 License registration

7.7 Scenario definition

Series	SECS/GEM communication software		
	Non-GEM version	GEM version	GEM advanced version
MELSEC-Q series	○	○	○
MELSEC iQ-R series	—	—	—

Defining a scenario allows sequential operation of two or more transactions with a single bit trigger.

Window

[Setting]⇒[Scenario Setting]

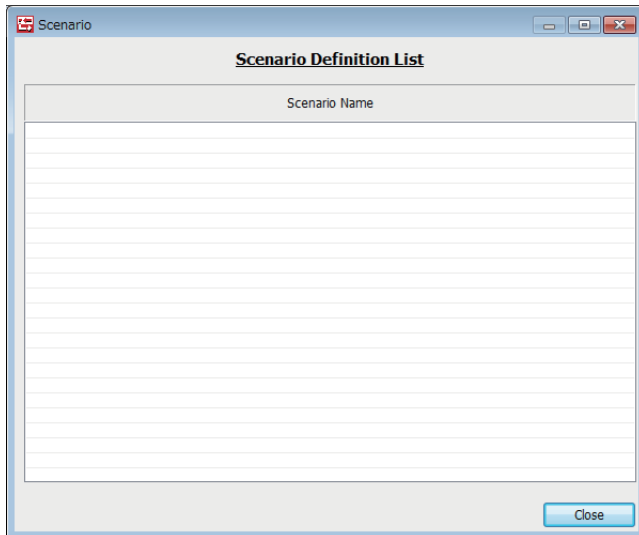

Operations of the Scenario List

Operation	Description
Right-click⇒Shortcut menu[Modify]	Display the "Scenario Setting" screen to modify the content of the selected scenario.
Right-click⇒Shortcut menu[Insert]	Add a new scenario.
Right-click⇒Shortcut menu[Duplicate]	Copy the selected scenario, and then copy the copied scenario to the row below.
Right-click⇒Shortcut menu[Move Up]	Move the selected scenario.
Right-click⇒Shortcut menu[Move Down]	
Right-click⇒Shortcut menu[Delete]	Delete the selected scenario.

Scenario Setting

Modify the scenario selected at the "Scenario" screen.

Window

Select a scenario at the "Scenario" screen, right-click⇒Shortcut menu [Edit]

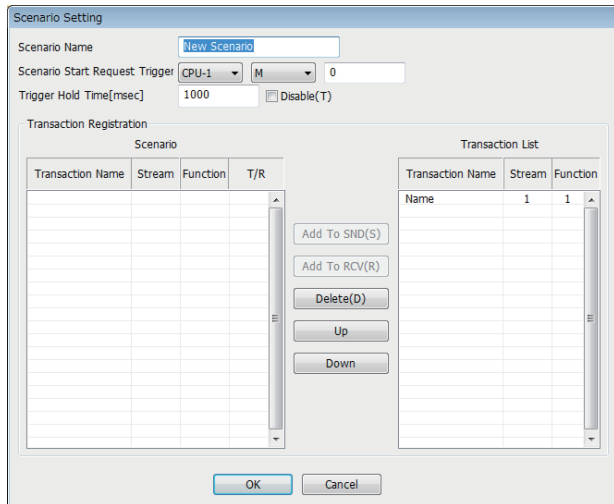

Displayed items

Item	Description
Scenario name	Configure the scenario name.
Scenario Start Request Trigger	Configure the trigger relay to request a scenario start from the programmable controller CPU.
Trigger Hold Time	When the scenario start request trigger is held for the configured time, a scenario start trigger results. If the "Disable" checkbox is selected, scenario start request trigger processing is carried out without hold monitoring.
Scenario	Lists the transactions registered to the scenario.
Definition transaction	Displays the defined transaction name and Stream and Function numbers. If an arbitrary transaction is selected, the [Add To SND] button or [Add To RCV] button can be clicked in correspondence with the transmission type of that transaction.
[Add To SND] button	Register the transaction selected by "Definition transaction" to the scenario.
[Add To RCV] button	
[Delete] button	Delete the transaction selected under "Scenario".
[Up] button	Change the order of transactions of "Scenario".
[Down] button	

Scenario transaction operation sequence

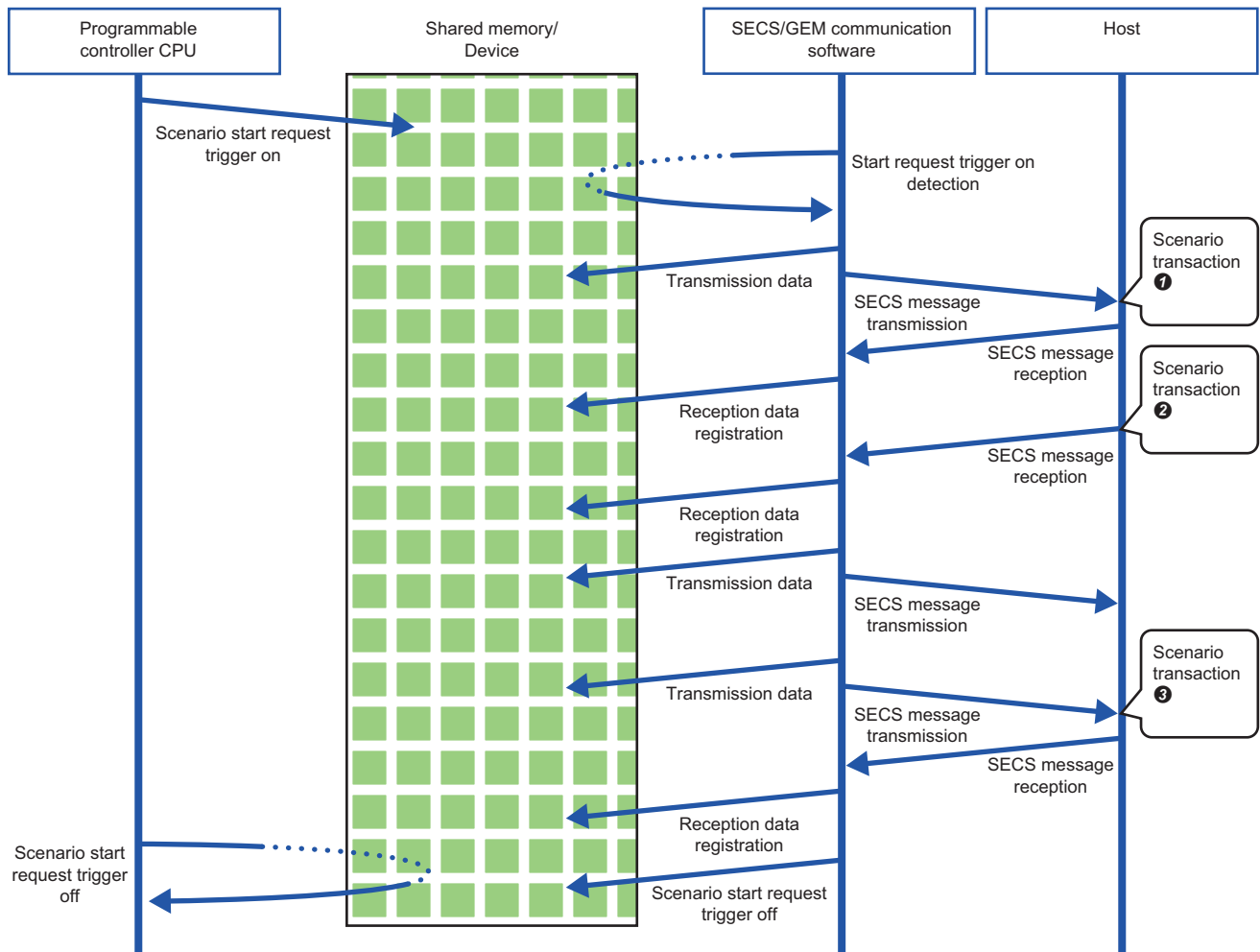

In the course of transaction operations within a scenario, the software refers to (for sending) or writes data to (for receiving) the related register without controlling the trigger relay.

Be aware that the registration-destination register is overwritten every time a message is received.

7.8 Alarm Definition (non-GEM version)

Alarm notification definitions allow arbitrary definition and sending of the content of the alarm notification used by S5F1. This is completed just by controlling the alarm occurrence/recovery trigger and the register that corresponds to the prescribed alarm at the programmable controller CPU.

Operations during Alarm Notification

When the occurrence of (or recovery from) an alarm has been detected, the fact that a prescribed alarm occurred (or was recovered from) is reported (S5F1 alarm sending) regarding a location in which the register status changed.

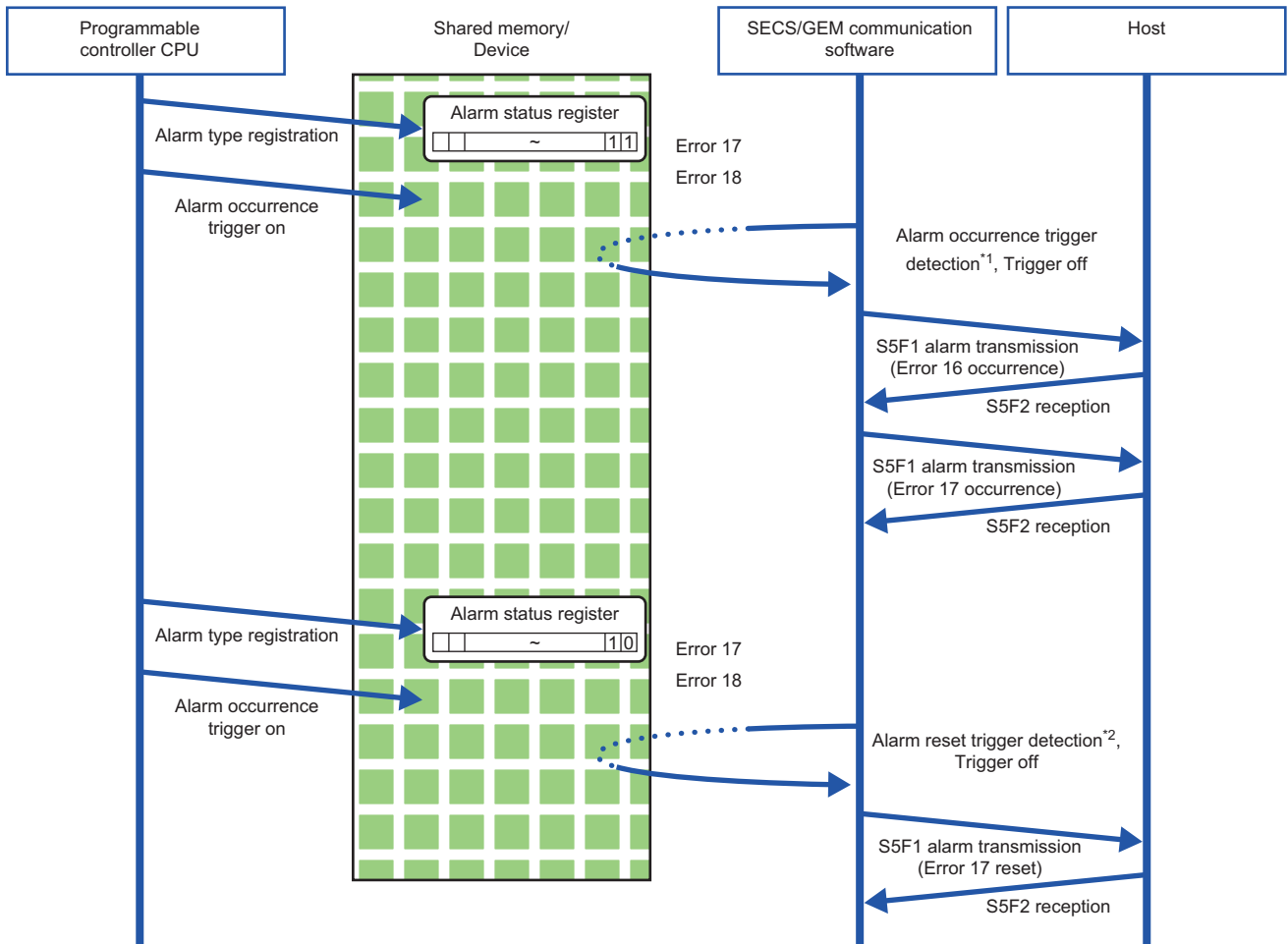

*1 Compares with the internal state to detect items in which the register status changed from 0 to 1. (For occurrence trigger)

*2 Compares with the internal state to detect items in which the register status changed from 1 to 0. (For recovery trigger)

Alarm List

Series	SECS/GEM communication software		
	Non-GEM version	GEM version	GEM advanced version
MELSEC-Q series	○	—	—
MELSEC iQ-R series	○	—	—

Displays a list of defined alarms.

Up to 4096 alarms can be defined here.

Window

 [Setting]⇒[Alarm]

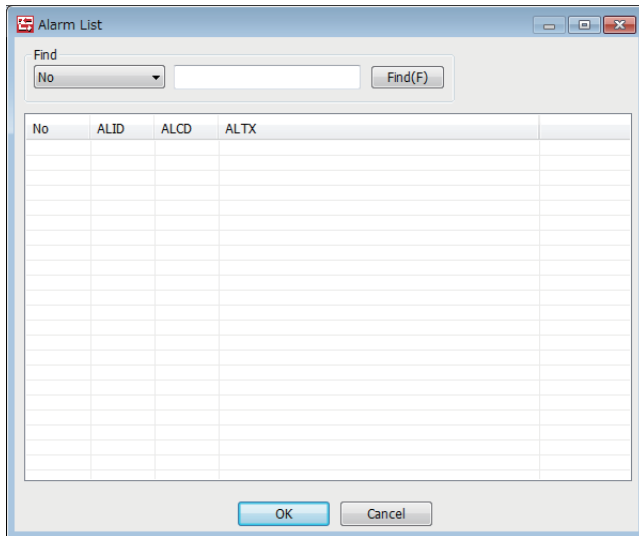

7

Operations of the Alarm List

Operation	Description
Right-click⇒Shortcut menu[Modify]	Display the "Alarm Settings" to modify the content of the selected alarm.
Right-click⇒Shortcut menu[Insert]	Add a new alarm.
Right-click⇒Shortcut menu[Duplicate]	Copy the selected alarm, and then copy the copied alarm to the row below.
Right-click⇒Shortcut menu[Move Up]	Move the selected alarm.
Right-click⇒Shortcut menu[Move Down]	
Right-click⇒Shortcut menu[Delete]	Delete the selected alarm.

Point

The content of the alarm list is saved to the following file.

(Project save destination)\ALARM.CSV

When the alarm content is large or redundant, it is convenient to use Microsoft Excel or another external editor to modify this file.

After the corresponding file is edited, the content is updated by opening the same project again.

Alarm Settings

Series	SECS/GEM communication software		
	Non-GEM version	GEM version	GEM advanced version
MELSEC-Q series	<input type="radio"/>	—	—
MELSEC iQ-R series	<input type="radio"/>	—	—

Window

 Select an alarm at the "Alarm List" screen, right-click⇒Shortcut menu [Edit]

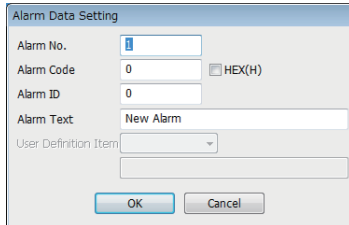

Displayed items

Item	Description
Alarm No.	Configure the number that corresponds to the prescribed alarm state register. (Start from 1)
Alarm code	Configure the content of the alarm code <ALCD > related to the alarm number.
Hexadecimal	Select this checkbox to convert the alarm code notation to hexadecimal. If this checkbox is cleared, the notation is decimal.
Alarm ID	Configure the content of the alarm ID <ALID > related to the alarm number.
Alarm text	Configure the content of the alarm text <ALTX > related to the alarm number.
User-defined items	Configure the content of the user-defined items related to the alarm number. To configure user-defined items, browse to the "Alarm Notification Settings" screen and configure "User-defined item quantity" in advance. For details on alarm notification settings, see the following reference.  Page 103 Alarm Notification Setting User-defined items can be used only for transactions with ALARM configured for the format specification. The content of user-defined items is sent by selecting the user-defined item name for the storage destination type of the item information.

Alarm Notification Setting



Series	SECS/GEM communication software		
	Non-GEM version	GEM version	GEM advanced version
MELSEC-Q series	○	—	—
MELSEC iQ-R series	○	—	—

Window

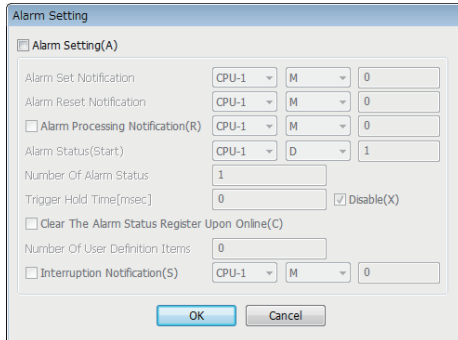
 [Setting]⇒[Alarm notification]



Displayed items

Item	Description
Alarm Notification Setting	— Select this checkbox to use the alarm notification setting.
Alarm Occurrence Notification	Configure the trigger relay to notify the SECS/GEM communication software of an alarm occurrence.
Alarm Reset Notification	Configure the trigger relay to notify the SECS/GEM communication software of an alarm reset.
Alarm Processing Notification	Configure the relay to report that alarm sending is being processed. Turned OFF by receipt of a secondary message of the final alarm message. It is possible to check that the ladder program is performing sending processing when a large number of alarms occur at once.
Alarm Status Register (Start)	Configure the register to display the alarm status.
No. of Alarm Status Registers	One register can manage the alarm status of 16 items. Configure the quantity of registers to be used according to the number of alarm items. Up to 256 registers can be configured (maximum alarm count is 4096).
Trigger Hold Time	A notification trigger results when the register configured for the alarm occurrence notification trigger or alarm recovery notification trigger was held for the configured time. If the "Not Monitored" checkbox is selected, notification trigger processing is carried out without hold monitoring.
Clearing the alarm status register during an online transition	Select this checkbox to clear the content of the alarm status register when an online state is established (S1F1/F2 transmission). When the alarm status register is cleared, the internal alarm status of the SECS/GEM communication software is cleared as well. If this checkbox is cleared, make the programmable controller CPU clear the alarm status register and internal alarm status as needed.
User-defined item quantity	Configure the maximum number of user-defined items used by transactions with ALARM configured for the format specification. For details on user-defined items, see the following reference.  Page 102 Alarm Settings
Report cancel notification relay	Configure the relay to report that the alarm is being canceled when a large number of alarms occurred at the same time. For more details, see the following reference.  Page 105 Alarm Cancel Notification

Precautions

■ Alarm report sending (S5F1/F2)

Alarm report sending (S5F1/F2) is a reserved transaction and is automatically sent. Configuring a transaction for this purpose is not required.

For details on reserved transactions, see the following reference.

☞ Page 268 List of reserved transactions and format

■ No. of Alarm Status Registers

When multiple registers are used, the consecutive registers from the specified start alarm status register up to the configured quantity targeted.

Make sure not to overlap with any register defined in other item settings.

■ Editing of ALARM.CSV

ALARM.CSV is a text file with items delimited by commas. When editing the data, take care not to change the file format.

Furthermore, back up and store the file before modifying it.

Alarm Cancel Notification

The SECS/GEM communication software may be affected when a large number of alarms occur at the same time.

To prevent this, the SECS/GEM communication software cancels alarms when 33 or more alarm reports are sent at the same time. Even when the number of alarm reports is 32 or less, alarm reports are canceled when the sending queue becomes full before all sending is finished.

With regard to canceled alarm reports, sending is started again by switching the alarm occurrence (or alarm recovery) trigger to ON, and the report cancel notification relay is switched OFF when all reports are completed.

In addition to the interlock of the alarm status register, a lock by the ladder program is necessary so that recovery processing is not performed until all alarm occurrences are completed when alarms are canceled during alarm occurrence processing.

Similarly, a lock is used to prevent occurrence processing midway when alarms are canceled during alarm recovery processing.

The following section shows the processing flow when 50 alarms have occurred.

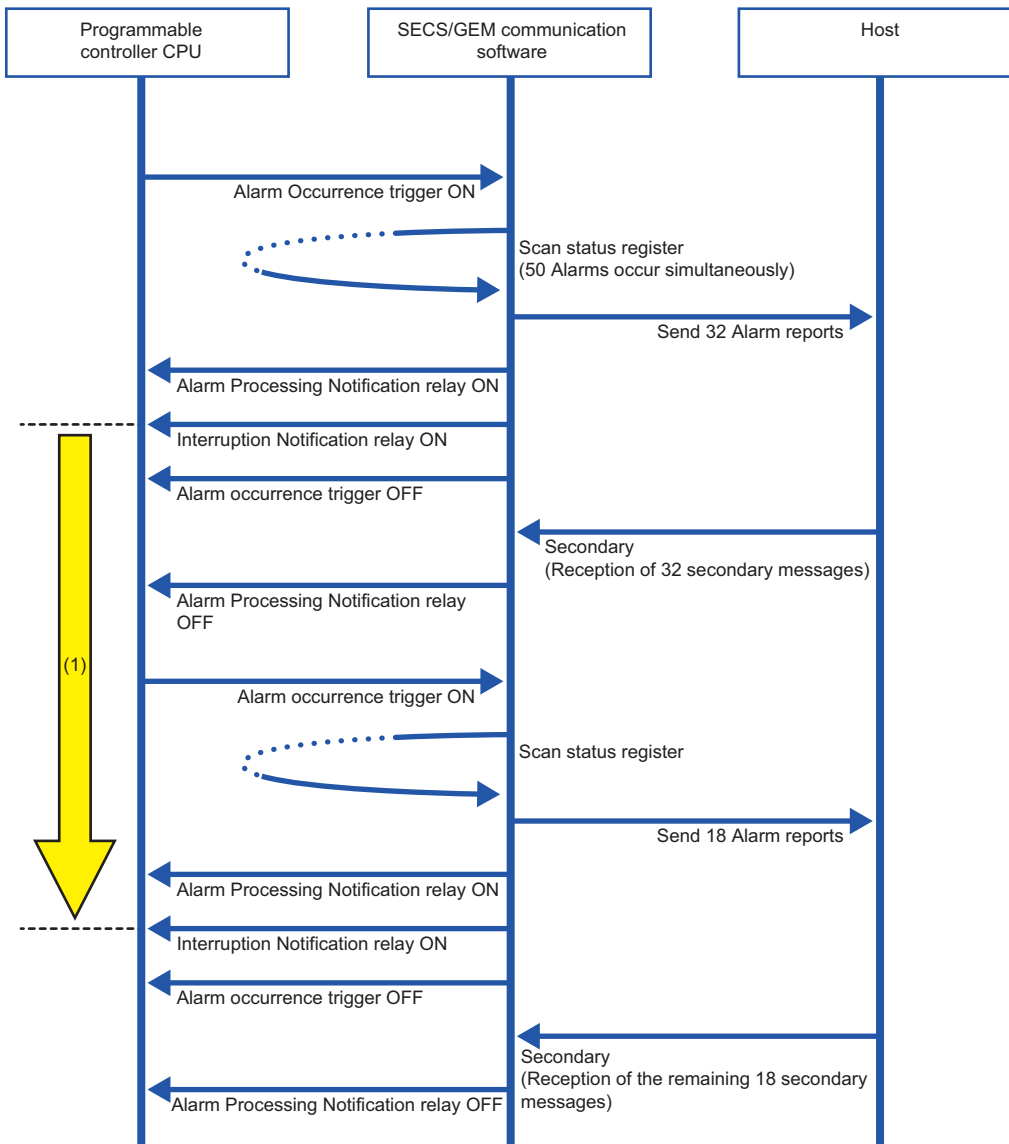

(1) Locked by the ladder program so that alarm recovery processing is not carried out until all alarm report sending is complete

7.9 Spooling function (non-GEM version)

Messages that failed to be sent for some reason can be kept as spool messages. Spooled messages can be resent when communication is recovered.

Spooled messages are stored on the memory card.

Spool Definition Settings

Series	SECS/GEM communication software		
	Non-GEM version	GEM version	GEM advanced version
MELSEC-Q series	<input type="radio"/>	—	—
MELSEC iQ-R series	<input type="radio"/>	—	—

Common Spool Definition settings

Window

[Setting]⇒[Spool]⇒[Spool Common Setting]

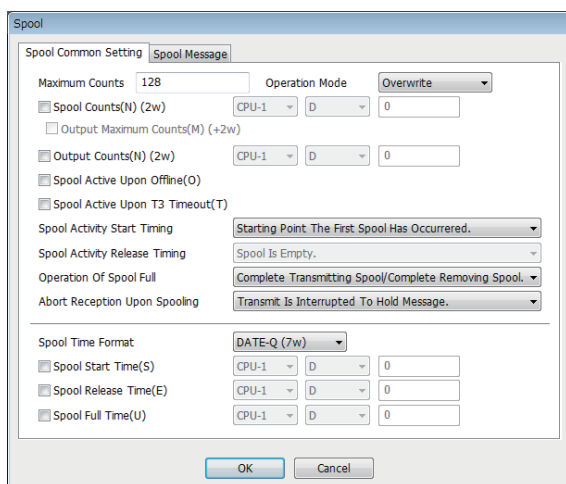

Displayed items

Item	Description
Maximum No. Of Spool Items	Configure the maximum number of messages to be spooled.
Action when data is exceeded	Select the operation method when the maximum number of items is exceeded. Overwrite: overwrite spooled messages. Discard: discard the overflow.
No. of Spool Items	—
Maximum number of data items output	Select this checkbox to output the maximum number of data items. The maximum number of data items output is stored from the register configured for spool items plus 2 word positions in data of two-word, 32-bit integers.
Number of output items	Configure the register to store the number of output items. The number of spool output items is stored to the register in 2-word, 32-bit integers.
Spool during offline	Select this checkbox to use the spool function in an offline state.
Spool due to a T3 timeout	Select this checkbox not to cancel communication and perform spooling due to a T3 timeout.
Spool activity start timing	Select the spool activity start timing. <ul style="list-style-type: none"> • Treat initial spool occurrence time as start: the spooling relay switches ON when messages were spooled, and the "Spool start time" is stored. • Treat communication error occurrence time as start: the spooling relay switches ON when a communication error (T3 timeout, etc.) occurred by a sending message, and the "Spool start time" is stored.
Spool activity cancel timing	Select the spool activity cancel timing. <ul style="list-style-type: none"> • Treated as cleared by empty spool: the spool is cleared when all spool messages of the spool buffer have been transferred or deleted.

Item	Description
Operation when spool is full	Select the spooling operation after the spool buffer becomes full. <ul style="list-style-type: none"> Spooling possible after spool transfer completion/deletion: after the number of spool items reaches the maximum, spooling is not possible again if the entire spool has not been transferred or deleted. Spooling possible with empty spool buffer: after the number of spool items has reached the maximum, spooling is possible, even when previous spool data remains, when the spool buffer could be emptied by spool transfer, etc.
Abort receipt during spool transmission	Select the operation when an abort message is sent for a spool transmission message. <ul style="list-style-type: none"> Message is retained and transfer is canceled: the transfer of the spool is canceled. At the next transfer, the transfer is started from a message that returned an abort. Skipped and transfer is continued: the spool transfer message that returned an abort is skipped, and transfer is continued automatically from the next spooled message. Transfer is completed when there is finally a spooled message.
Spool time storage format	Select the format of the spool start time, spool cancel time, and spool-full time to be stored to the specified register. For more details of each format, see the following reference.  Page 79 Register storage formats
Spool-start time	Configure the register to store the time the spool started.
Spool-cancel time	Configure the register to store the time the spool cancelled.
Spool-full time	Configure the register to store the time until the maximum number of spool items was reached.

■Number of output items

- The number of spool output items is counted from receipt of an S6F23 (Spooled data request) transfer request.
- Previous values are not retained due to a reset. (Values are not retained after reset.)
- Counted as output items when the spool was discarded.
- Counted as one item by spool transmission success. (When there is a W-bit, when a secondary message is received).
- The final result is stored before the Spooling relay or Spool outputting relay is turned OFF.
- Two words each are used for the number of spool items, maximum number of data items, and number of output items, so take care not to overlap with other register settings.

■Abort receipt during spool transmission setting

- If "Set communication as disconnected by receipt of an abort of message subject to spooling" is enabled at the [Control 1] tab of Option Configure tings and "Skip and continue transfer" is configured, "Skip and continue transfer" is prioritized, and communication is not disconnected when an abort message is received during spool transmission. At times other than spool transmission, communication is disconnected when the conditions are met.
- In the case of "Abort Frame Reception" at the SECS Error Notification Setting tab of the Option settings, a relay notification is performed regardless of the "Abort receipt during spool transmission" setting.

■Important points regarding spool definition settings

- The SECS/GEM communication software does not turn OFF the sending request relay unless message sending is completed. Accordingly, when primary messages are to be sent, it is necessary to describe the handshake response monitoring timer processing of the SECS/GEM communication software at the programmable controller CPU. At this time, the spooling relay turns ON when there are messages subject to spooling.
- When the spooling relay is ON, the SECS/GEM communication software does not send a message when the equipment attempts to send a primary message not subject to spooling. However, S1 and S9 related messages are sent.

■Considerations when switching the power ON or OFF

- Before turning OFF the power of the C Controller module, disable spooling or move the Mode switch of the C Controller module from RUN to STOP, and then wait 3 seconds or more. To prevent corruption of logs and spooling files, all file writing is stopped. Furthermore, return the Mode switch to RUN before turning ON the power. Operation may be affected because there are limits on file access during start-up.
- Before turning OFF the power of the C intelligent function module, disable spooling or unmount the SD card (by moving the Mode switch of the C intelligent function module from the center to SELECT for 3 seconds or more). To prevent corruption of logs and spooling files, all file writing is stopped. Furthermore, return the Mode switch to the center before turning ON the power. Operation may be affected because there are limits on file access during start-up.

Spool message settings

Window

[Setting]⇒[Spool]⇒[Spool Message Settings]

The screenshot shows the 'Spool Message' settings window. It features a 'Message Selection' section with a dropdown for 'Name (S1:F1)', an 'Item' dropdown, and a 'Find(F)' button. Below this is a 'Spool Flag Item Path' dropdown. There are 'Up', 'Down', 'Add(A)', 'Modify(C)', and 'Delete(D)' buttons. A table with columns 'Transaction Name', 'S..', 'F..', 'Item Name', and 'Spool Flag Item Path' is shown. At the bottom are 'OK' and 'Cancel' buttons.

Displayed items

Item	Description
Message selection	Select the defined message name and Stream/Function number.
Item specification	Select an item. Use when a spool flag is included in the item of a message subject to spool. In this way, the spool flag distinguishes between normal sending and spooling sending. <ul style="list-style-type: none">• Normal sending: conforms to item information• Spooling sending: fixed to "1" When the corresponding item is used as a spool flag, the defined item name is displayed for messages with the spool flag selected, so click the [Search] button. Confirm the message flag path, and then click and configure each button.
Spooling setting list display	A list of defined spool messages is displayed. If a message is selected, the message content and spool flag path are displayed.
[Up] button	Change the order of messages of "Spooling setting list display"
[Down] button	
[Add] button	Configure new spool messages.
[Modify] button	Change a spool flag of an already configured message.
[Delete] button	Cancel messages subject to spooling.

Precautions

The setting of the spool flag path is defined for content already configured. Accordingly, be aware that it is necessary to configure the spool flag path setting again when the corresponding message was changed.

Spooled message sending

Series	SECS/GEM communication software		
	Non-GEM version	GEM version	GEM advanced version
MELSEC-Q series	○	—	—
MELSEC iQ-R series	○	—	—

For messages subject spooling, operations are performed particular to the status.

The following section shows operations of messages that can and cannot be sent due to status.

Message classification	Online	Spooling online	Offline*1
Message subject to spooling	Sending possible	Spooling	Spooling
Message not subject to spooling	Sending possible	Sending not possible	Sending not possible (sending cancellation)
S1 message	Sending possible	Sending possible	Sending possible only for S1F1 and S1F13
S9 message*2	Sending possible (automatic)	Sending possible (automatic)	Sending possible (automatic)

*1 When the "Spool during offline" setting is enabled

*2 For S9 messages, sending is automatic, so handshakes are not performed.

Spooling Operation Sequence

If message sending fails due to a line disconnection, etc., messages subject to spooling are stored on the memory card. Also, messages subject spooling are not sent and are all stored on the memory card while the spooling relay is ON.

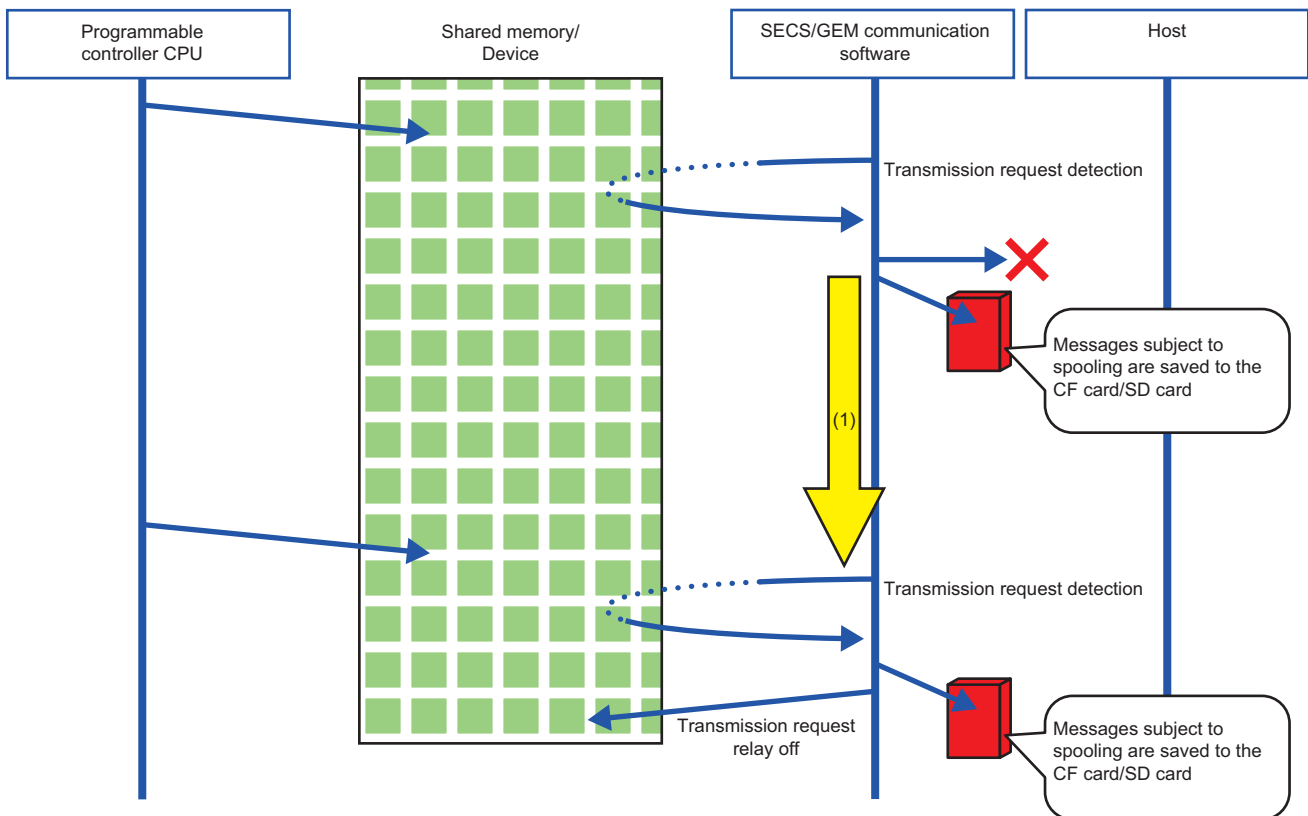

(1) The spooling relay is ON.

Operation sequence during spool message sending

All spool sending is performed by the SECS/GEM communication software.

The spool outputting relay is ON during spool sending, and then switches OFF when complete. At this time, the spooling relay is also OFF.

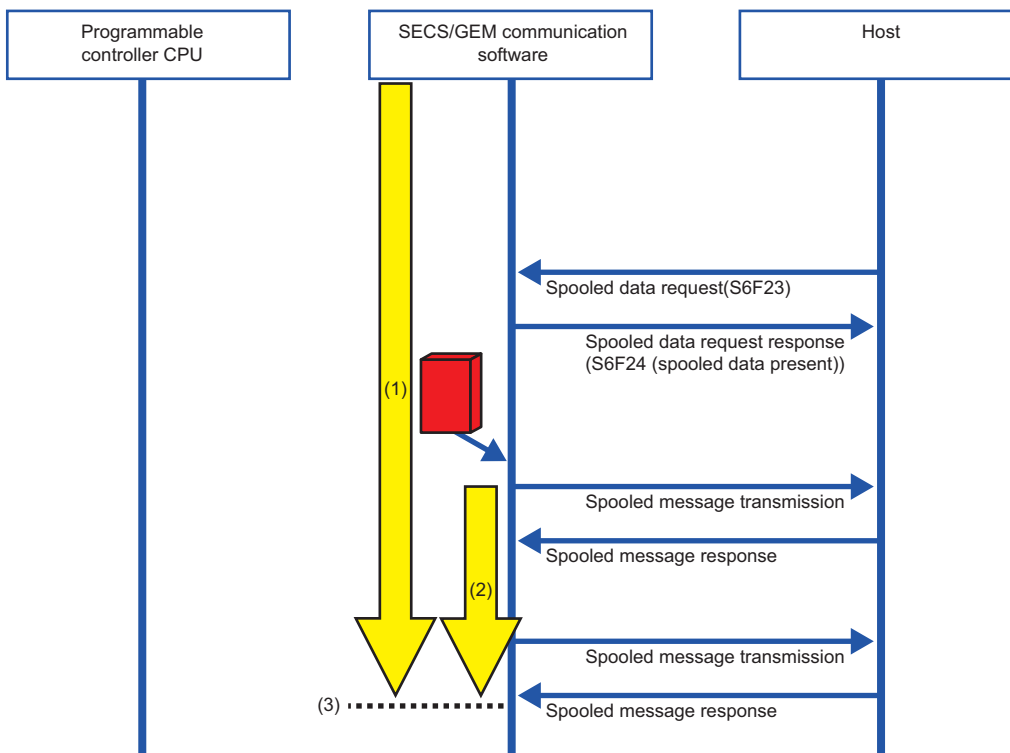

(1) The spooling relay switches ON.

(2) The spooling outputting relay switches ON.

(3) The spool outputting relay and spooling relay switch OFF.

7.10 Project Archive File Get

Series	SECS/GEM communication software		
	Non-GEM version	GEM version	GEM advanced version
MELSEC-Q series	<input type="radio"/>	<input type="radio"/>	<input type="radio"/>
MELSEC iQ-R series	<input type="radio"/>	<input type="radio"/>	<input type="radio"/>

Acquire the user definition archive (USRSET.LZH) transferred to the SECS/GEM communication software pre-installed model module and put it in the prescribed folder.

The user definition archive is obtained from the "Destination" configured by the C intelligent module update or C Controller update.

Point 

In the case of the MELSEC iQ-R series SECS/GEM communication software pre-installed model module, change "C Controller" to "C intelligent function module".

Window

 [Setting]⇒[Project Archive File Get]

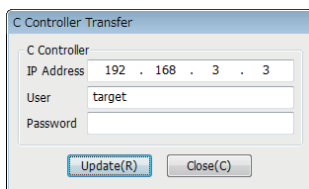

Displayed items

Item	Description
IP Address	Configure the IP address of the SECS/GEM communication software pre-installed model module.
User	Configure the username (login name) of the SECS/GEM communication software pre-installed model module.
Password	Configure the password of the SECS/GEM communication software pre-installed model module.

Operating procedure

1. Specify the folder to store the user definition archive to be acquired at the "Browse Folder" screen.
2. Configure the items of the "Project Archive File Get" screen.
3. Click [Get].
4. Click [OK].

7.11 Updating the SECS/GEM communication software pre-installed model module

Series	SECS/GEM communication software		
	Non-GEM version	GEM version	GEM advanced version
MELSEC-Q series	<input type="radio"/>	<input type="radio"/>	<input type="radio"/>
MELSEC iQ-R series	<input type="radio"/>	<input type="radio"/>	<input type="radio"/>

From the setting tool, connect to the SECS/GEM communication software pre-installed model module, and then update the setting file stored on the standard ROM or memory card.

If the file is updated, the setting tool is used to apply the configured content to the SECS/GEM communication software.

Precautions

- Always save the project before using this function.
- Set the same location (standard ROM or memory card) for the application installation destination, setting file update destination, and the license registration destination.
- When the application was installed on the standard ROM and memory card, the application on the memory card runs.
- Do not switch the power supply from OFF to ON while the SECS/GEM communication software pre-installed model module is updating. Otherwise, the internal file system may be corrupted.

Window

- 🔗 [Setting] ⇒ [Update C intelligent function module] (When a MELSEC iQ-R series SECS/GEM communication software pre-installed model module is used)
- [Setting] ⇒ [Update C Controller module] (When a MELSEC-Q series SECS/GEM communication software pre-installed model module is used)

Displayed items

Item		Description
C intelligent module		Select to transfer the setting file to the Standard ROM or memory card.
C Controller module		
SD card transfer		Select to save the setting file to the memory card via a card reader.
CF card transfer		
—	IP Address	Configure the IP address of the SECS/GEM communication software pre-installed model module.
	User	Configure the username (login name) of the SECS/GEM communication software pre-installed model module.
	Password	Configure the password of the SECS/GEM communication software pre-installed model module.
	Destination	Select the transfer destination of the setting file.
Operation After Updating		Select an operation after updating. For more details, see the following reference.  Page 113 Operation After Updating
Operations at start-up	Variable Setup ^{*1}	Select whether to change to match the variable definition content the next time the SECS/GEM communication software starts.
	Configuration File Browse ^{*1}	Select the setting file to be referenced the next time the SECS/GEM communication software starts.
Project Archive File Transfer		Select this checkbox to archive and transfer the setting file information. If the information is transferred, the file "USRSET.LZH" is created in the folder of the transfer destination.
Applications Install		Select this checkbox to transfer the application file of the SECS/GEM communication software from the SECS/GEM communication software pre-installed model module.

*1 Can be configured for only a GEM version and GEM advanced version.

Operation After Updating

The following section shows the operations after an update of the SECS/GEM communication software pre-installed model module.

■No Operation (Only Update)

The setting file is updated.

The setting content is applied the next time the SECS/GEM communication software pre-installed model module is started.

■Restart (Reboot the Software)

Update the setting file, and then restart only the SECS/GEM communication software. Do not restart the SECS/GEM communication software pre-installed model module.

The shared memory / device information is not changed.

The settings can be updated without stopping the equipment.

7.12 IP address setting

Series	SECS/GEM communication software		
	Non-GEM version	GEM version	GEM advanced version
MELSEC-Q series	<input type="radio"/>	<input type="radio"/>	<input type="radio"/>
MELSEC iQ-R series	<input type="radio"/>	<input type="radio"/>	<input type="radio"/>

You can change the IP address of the SECS/GEM communication software pre-installed model module using the setting tool. The IP address is stored in a register of the programmable controller CPU and can also be changed from the ladder program that uses this register.



Note that changes of the IP address of the SECS/GEM communication software pre-installed model module by this function are effective only when the SECS/GEM communication software is running.

By using this function, the IP address and subnet mask can be changed but not the default gateway.

This section shows the procedure to configure the IP address.

Operating procedure

1. Configure the IP address using one of the following methods.

-  Page 116 Changing the IP address from the setting tool
-  Page 117 IP Address Setting by PLC

2. Reset the SECS/GEM communication software pre-installed model module.

The IP address is changed after the reset. (An event is registered to the event history of the Setting/monitoring tools for the C Controller module or GX Works3.)

Point

To change the IP address of the SECS/GEM communication software pre-installed model module, it is recommended to use Setting/monitoring tools for the C Controller module or GX Works3.

Precautions

■Change of the IP address

Carefully check the IP address before changing it.

If the IP address of the MELSEC iQ-R series SECS/GEM communication software pre-installed model module is changed to an incorrect address, it may be necessary to initialize the MELSEC iQ-R series SECS/GEM communication software pre-installed model module.

Even when the IP address of the MELSEC-Q series SECS/GEM communication software pre-installed model module was changed to an incorrect address, the address can be corrected by obtaining the file and updating it via serial communication when the console of the Option settings is configured. If the console is not configured, it may be necessary to initialize the MELSEC-Q series SECS/GEM communication software pre-installed model module.

For details on initialization, see the following reference.

 MELSEC iQ-R C Intelligent Function Module User's Manual (Application)

 MELSEC-Q C Controller Module User's Manual

■Application of settings

The IP address is not changed during system operation. Always perform a reset to change the IP address.

■reset

Before performing a reset, make sure that the CIM control ready relay is ON.

In addition, if the MELSEC-Q series SECS/GEM communication software pre-installed model module is operating in the basic mode, two reset operations are required to change the IP address.

■When the IP address of the MELSEC iQ-R series SECS/GEM communication software pre-installed model module was changed

When this function is used to configure the IP address of the MELSEC iQ-R series SECS/GEM communication software pre-installed model module, 'IP address configuration file' remains in the standard ROM.

Therefore, IP address settings from GX Works3 to the MELSEC iQ-R series SECS/GEM communication software pre-installed model module are not effective when the SECS/GEM communication software is running.

Refer to the following file before deleting the IP address configuration file without initializing the Standard ROM.

- (CA-SECS installation folder)/RECOVERY/ReadMe.txt

Changing the IP address from the setting tool

Change the IP address of the SECS/GEM communication software pre-installed model module from the setting tool.

Point

In the case of the MELSEC iQ-R series SECS/GEM communication software pre-installed model module, change "C Controller" to "C intelligent function module".

Window

[Function]⇒[IP Address Setting]

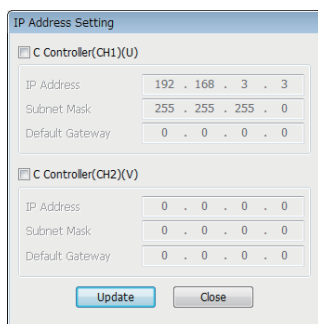

Operating procedure

1. Choose the Ethernet port to change the IP address.
2. Set each item.
3. Click the [Update] button.
4. A screen appears. Enter the IP address, user, and password of the target SECS/GEM communication software pre-installed model module.

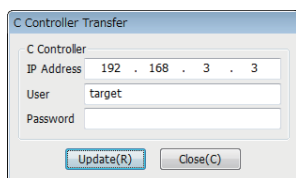

5. Click the [Update] button.

After transfer, the IP addresses is changed by resetting the SECS/GEM communication software pre-installed model module.

Precautions

- The default gateway cannot be changed by using this function.
- The MELSEC iQ-R series SECS/GEM communication software pre-installed model module has only one Ethernet port, so CH2 cannot be configured.

IP Address Setting by PLC

The IP address of the SECS/GEM communication software pre-installed model module can be changed by a handshake with the SECS/GEM communication software.

Use this procedure, for example, when changing the IP address from the equipment display.



In the case of the MELSEC iQ-R series SECS/GEM communication software pre-installed model module, change "C Controller" to "C intelligent function module".

Window

[Function]⇒[IP Address Setting by PLC]

Displayed items

Item		Description
IP Address (CH1) Setting By PLC	—	Select this checkbox to change the IP addresses of CH1.
	Setting Request Trigger	Configure the trigger to configure the IP address of CH1.
	Start Register (12w)	Configure the register to store the IP address information to be configured to CH1.
IP Address (CH2) Setting By PLC	—	Select this checkbox to change the IP addresses of CH2.
	Setting Request Trigger	Configure the trigger to configure the IP address of CH2.
	Start Register (12w)	Configure the register to store the IP address information to be configured to CH2.

Operating procedure

1. Configure "Setting Request Trigger" and "Start Register" at the "IP Address Setting By PLC" screen.
2. The IP address information is configured by the ladder program as shown below.

Storage destination register	Description
0 to +3	IP Address
+4 to +7	Subnet Mask
+8 to +11	Not used

3. Configure the setting trigger.

The SECS/GEM communication software switches OFF the setting trigger.

The file necessary to change the IP address on the SECS/GEM communication software pre-installed model module is created by the SECS/GEM communication software.

4. Reset the SECS/GEM communication software pre-installed model module.

After resetting, the IP address of the SECS/GEM communication software pre-installed model module is changed.

Precautions

- The default gateway cannot be changed by using this function.
- The MELSEC iQ-R series SECS/GEM communication software pre-installed model module has only one Ethernet port, so CH2 cannot be configured.

IP address information

The IP address, subnet mask, and default gateway are configured by four words each.

When the SECS/GEM communication software starts, the IP address information currently configured for the SECS/GEM communication software pre-installed model module is stored in the IP address information.

The following section shows a configuration sample.

Register	Description			
	+0W	+1W	+2W	+3W
+0W (IP address)	192	168	3	3
+4W (Subnet mask)	255	255	255	0
+8W (Unused)	0	0	0	0

7.13 Data Mapping Settings

Series	SECS/GEM communication software		
	Non-GEM version	GEM version	GEM advanced version
MELSEC-Q series	<input type="radio"/>	<input type="radio"/>	<input type="radio"/>
MELSEC iQ-R series	<input type="radio"/>	<input type="radio"/>	<input type="radio"/>

The mapping function can add sending request trigger relays and reception notification trigger relays to the selected transactions and map offsets to the data control register as a command.

In this way, it is possible to configure as shown below for one transaction definition.

- Sending message: report data from control registers with different offsets by separating sending request trigger relays.
- Receiving message: assign control registers and reception notification trigger relays to register reception data by the values of items.

Window

 [Function]⇒[Data Mapping Setting]

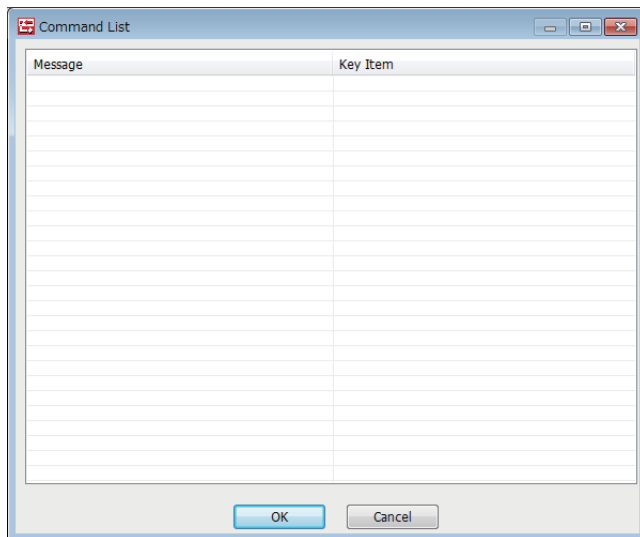

Operations of the Command List

Operation	Description
Right-click⇒Shortcut menu[Modify]	Display the "Command Setting" screen to modify the content of the selected command setting.
Right-click⇒Shortcut menu[Insert]	Add a new command setting.
Right-click⇒Shortcut menu[Duplicate]	Copy the selected command setting, and then add the copied command setting to the row below.
Right-click⇒Shortcut menu[Move Up]	Move the selected command setting.
Right-click⇒Shortcut menu[Move Down]	
Right-click⇒Shortcut menu[Delete]	Delete the selected command setting.

Command Setting

Window

Select a command setting at the "Command List" screen, right-click⇒Shortcut menu [Edit]

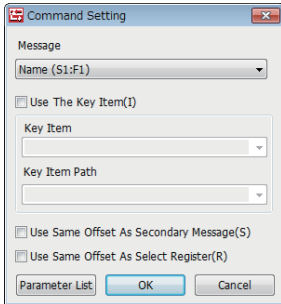

Displayed items

Item	Description
Message	Select the message to configure the command setting.
Use The Key Item	Select this checkbox to use the item property defined in the transaction as the key item. The checkbox selection is fixed when a primary message to be received is selected.
Key Item	Select the item property to serve as the key item.
Key Item Path	Select the item path for the item property selected as the key item. When there are multiple names identical to the key item within the same message, select the corresponding key item path.
Use Same Offset As Secondary Message	Select this checkbox to use the same offset in the transmission area of the secondary message information of the selected message.
Use Same Offset As Select Register	Select this checkbox to use the same offset Select Register of the selected message.

Parameter List

Window

Select a command setting at the "Command List" screen, right-click⇒Shortcut menu [Edit]⇒[Parameter List]

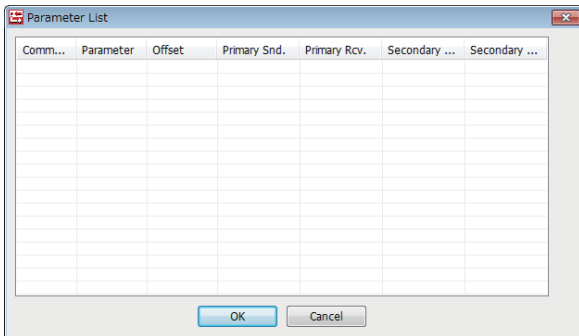

Operations of the Parameter List

Operation	Description
Right-click⇒Shortcut menu[Modify]	Display the "Parameter Setting" screen to modify the content of the selected parameter.
Right-click⇒Shortcut menu[Insert]	Add a new parameter.
Right-click⇒Shortcut menu[Duplicate]	Copy the selected parameter, and then copy the copied parameter to the row below.
Right-click⇒Shortcut menu[Move Up]	Move the selected parameter.
Right-click⇒Shortcut menu[Move Down]	
Right-click⇒Shortcut menu[Delete]	Delete the selected parameter.

Parameter setting

Window

Select a parameter to be configured at the "Parameter List" screen, right-click⇒Shortcut menu [Edit]

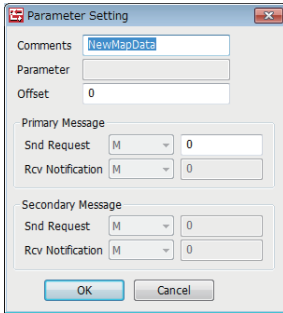

Displayed items

Item	Description
Comment	Enter a comment.
Parameter	Configure the value of the key item defined in the command setting. The value depends on the item property data type specified as the key item.
Offset	Configure the offset value for the control register to be defined by the item information.
Primary message	Configure the sending request trigger relays and reception notification trigger relays to be added to the primary messages subject to command settings. The device type retains the settings of target primary messages.
Secondary message	Configure the sending request trigger relays and reception notification trigger relays to be added to the secondary messages subject to command settings. The device type retains the setting of target secondary messages.

Mapping Setting Example

The following section describes an example of the register configuration and settings of the mapping by command function. In this example, transmission messages have the following structure.

Message format	Notes
<Message>	
<L, 2>	
A <KeyItem>	
<L, 256>	
U2 <Item1>	Control Register: W(0x0000)
U2 <Item2>	Control Register: W(0x0001)
U2 <Item3>	Control Register: W(0x0002)
⋮	⋮
U2 <Item256>	Control Register: W(0x00FF)

Sending message example

Select the transactions of trigger settings below for targets of command settings.

Because this is a primary message sending example, the reception notification trigger of the primary message and the sending request trigger of the secondary message are not defined.

Primary message information		Secondary message information	
Sending request trigger	Reception notification trigger	Sending request trigger	Reception notification trigger
B100	—	—	B400

The parameters are configured by the command settings as indicated below.

Parameter	Offset	Primary message information		Secondary message information	
		Sending request trigger	Reception notification trigger	Sending request trigger	Reception notification trigger
ParameterA	100	B101	—	—	B401
ParameterB	200	B102	—	—	B402

When a message added by parameter settings is sent, the specified offset is executed for the control register devices of each item defined in the message by the sending procedure as shown below, and the command register to be used is changed.

Control Register		Operation Procedure
W 0x0000	Item1	When B100 was switched ON as the sending request trigger, the software acquires data from the control registers configured in the items defined in the message.
	Item2	
	Item3	
	⋮	
	Item256	
W 0x0100	Item1	When B101 was switched ON as the sending request trigger, the software acquires data from the register area that offsets the device numbers of the control registers configured in the items defined in the message by 100.
	Item2	
	Item3	
	⋮	
	Item256	
W 0x0200	Item1	When B102 was switched ON as the sending request trigger, the software acquires data from the register area that offsets the device numbers of the control registers configured in the items defined in the message by 200.
	Item2	
	Item3	
	⋮	
	Item256	

Reception message example

Select the transactions of trigger settings below for targets of command settings.

Because this is a primary message receiving example, the sending request trigger of the primary message and the reception notification trigger of the secondary message are not defined.

Primary message information		Secondary message information	
Sending request trigger	Reception notification trigger	Sending request trigger	Reception notification trigger
—	B200	B300	—

The parameters are configured by the command settings as indicated below.

Parameter	Offset	Primary message information		Secondary message information	
		Sending request trigger	Reception notification trigger	Sending request trigger	Reception notification trigger
ParameterA	100	—	B201	B301	—
ParameterB	200	—	B202	B302	—

When a message added by parameter settings is received, the specified offset is executed for the control register devices of each item defined in the message by the reception procedure as shown below, and the command register to be used is changed.

Control Register		Operation Procedure
W 0x0000	Item1	When the value of the received key item does not match the value configured for the parameter, configure the data to the control register configured by the item defined in the message.
	Item2	
	Item3	
	⋮	
	Item256	
W 0x0100	Item1	When the value of the received key item matches "ParameterA", configure the data to the register area offset by 100 to the number of the control register configured by the item defined in the message.
	Item2	
	Item3	
	⋮	
	Item256	
W 0x0200	Item1	When the value of the received key item matches "ParameterB", configure the data to the register area offset by 200 to the number of the control register configured by the item defined in the message.
	Item2	
	Item3	
	⋮	
	Item256	

Precautions

Comparison of values of key items is determined after removing the space padding of the received item value.

7.14 Conversion Table Setting

Series	SECS/GEM communication software		
	Non-GEM version	GEM version	GEM advanced version
MELSEC-Q series	<input type="radio"/>	<input type="radio"/>	<input type="radio"/>
MELSEC iQ-R series	<input type="radio"/>	<input type="radio"/>	<input type="radio"/>

The data before and after replacement can be registered to the conversion table.

Flexible data transfer between the programmable controller CPU and SECS/GEM communication software is possible by applying a conversion table to the message items.

Window

 [Function]⇒[Data Convert Setting]

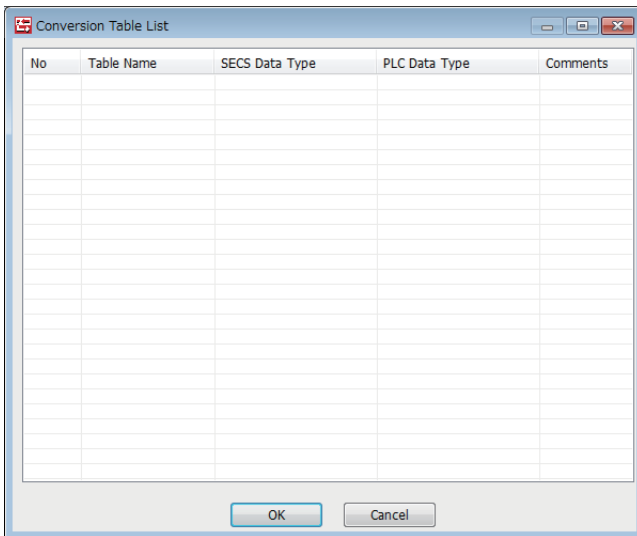

Operations of the Conversion Table List

Operation	Description
Right-click⇒Shortcut menu[Modify]	Display the "Conversion Table" screen to modify the content of the selected conversion table.
Right-click⇒Shortcut menu[Insert]	Add a new conversion table.
Right-click⇒Shortcut menu[Duplicate]	Copy the selected conversion table, and then copy the copied conversion table to the row below.
Right-click⇒Shortcut menu[Move Up]	Move the selected conversion table.
Right-click⇒Shortcut menu[Move Down]	
Right-click⇒Shortcut menu[Delete]	Delete the selected conversion table.

Conversion Table Setting

Window

Select a conversion table at the "Conversion Table List" screen, right-click⇒Shortcut menu [Edit]

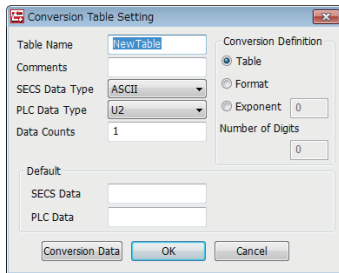

Displayed items

Item	Description	
Table name	Configure the table name.	
Comment	Configure the comment.	
SECS Data Type	Select the data type to be handled in SECS messages. The number of data sets and variable length setting are in accordance with the definition of the item to be applied.	
PLC Data Type	Select the data type to be handled in control registers.	
Data Counts	Configure the number of data sets when saving to a register. Set from 1 through 128 when "ASCII" or "JIS8" is the SECS and PLC data type Set 0 or 1 in other cases.	
default value	SECS Data	Configure the default value of data to be handled in SECS messages. Data is regarded as before replacement during reception and after replacement during sending. When the data does not match the conversion data created at the "Conversion data definition" screen, operation is performed using this value.
	PLC Data	Configure the default value of data to be handled in control registers. Data is regarded as after replacement during reception and before replacement during sending. When the data does not match the conversion data created at the "Conversion data definition" screen, operation is performed using this value.
Conversion definition	Table	Select to register data before and after replacement to the conversion table. Clicking the [Conversion Data] button displays the Conversion Data List screen.
	Format	Select to define the conversion string format to be applied to the data before replacement. Clicking the [Conversion Data] button displays the Format Conversion Definition Setting screen.
	Exponent	—
	Number of digits in the integer part ^{*1}	Select to define n of the index (nth power of 10) to be applied to the data before replacement. The exponential range is from -6 to 6. Specify the number of digits in the integer part. The number of digits is 0 to 16. If the integer part is less than the number of digits, fill it with "0". If 1 is specified, 0 suppression results; if 0 is specified, 0 suppression also results for the fractional part as well.
[Conversion Data] button	Configure the details when "Table" or "Format" was selected at "Conversion Definition".	

*1 Cannot be configured by a GEM or GEM advanced version of the MELSEC iQ-R series SECS/GEM communication software pre-installed model module.

Precautions

Comparison with the conversion table is determined after removing the space padding of the received item value.

Conversion Data List

Window

Click the [Conversion Data] button at the "Conversion Table" screen.

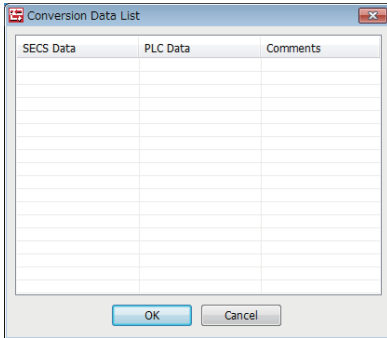

Operations of the Conversion Data List

Operation	Description
Right-click⇒Shortcut menu[Modify]	Display the "Conversion Data" screen to modify the content of the selected conversion data.
Right-click⇒Shortcut menu[Insert]	Add a new conversion data.
Right-click⇒Shortcut menu[Duplicate]	Copy the selected conversion data, and then copy the copied conversion data to the row below.
Right-click⇒Shortcut menu[Move Up]	Move the selected conversion data.
Right-click⇒Shortcut menu[Move Down]	
Right-click⇒Shortcut menu[Delete]	Delete the selected conversion data.

Conversion Data Setting

Window

Select conversion data at the "Conversion Data List" screen, right-click⇒Shortcut menu [Edit]

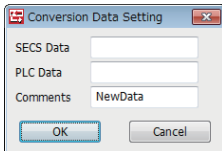

Displayed items

Item	Description
SECS Data	Configure the data to be handled in SECS messages. Data is regarded as before replacement during reception and after replacement during sending.
PLC Data	Configure the data to be handled in control registers. Data is regarded as after replacement during reception and before replacement during sending.
Comment	A comment can be entered.

Example of Conversion Table Use

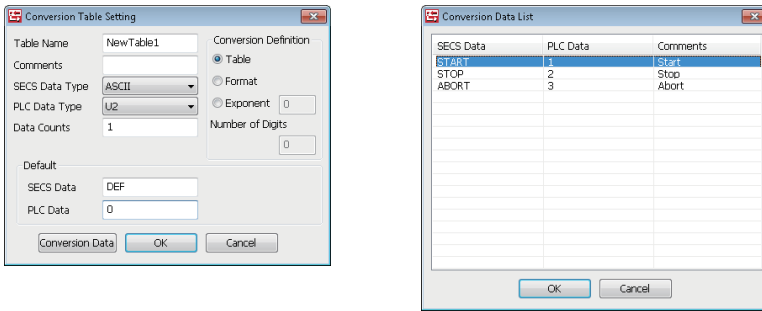

Message sending

Register Value	Description
1	Send START.
2	Send STOP.
3	Send ABORT.
Other than above	Send DEF (default value). When a default value (SECS data) has not been entered, sending fails.

Message reception

Reception Data	Operation
START	Configures "1" to the item storage register.
STOP	Configures "2" to the item storage register.
ABORT	Configures "3" to the item storage register.
Other than above ("SETUP," etc.)	Configures "0" to the item storage register. When a default value (stored data) has not been entered, S9F7 is returned.

Format conversion definition setting

While normally BIN → ASCII conversion format is left-aligned with space padding, the format conversion definition setting function allows you to freely define the format, such as right-aligned with zeros suppressed.

At the "Conversion Table Setting" screen, configure all items below, and then click [Conversion Data]. The "Format Conversion Definition Setting" screen opens.

- SECS Data Type: ASCII
- Conversion Definition: Format

Window

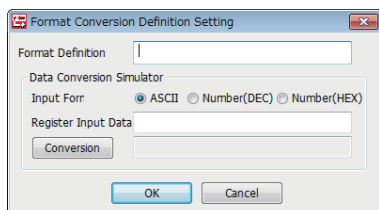

Displayed items

Item	Description
Format Definition	Configure the conversion string format. For the format, see the following reference. Page 129 Conversion string format
Input Form	Configure how conversion string data is to be treated. <ul style="list-style-type: none">• ASCII: Conversion strings are treated as ASCII.• Decimal: Conversion strings are treated as a numerical value (decimal).• Hexadecimal: Conversion strings are treated as a numerical value (hexadecimal).
Register Input Data	Configure the conversion verification value. The value is configured as test data for verifying the format defined as the format conversion format.
[Conversion] button	Check the conversion results of the defined format definition.

Precautions

"ASCII" must be configured for the SECS data type. When a data type other than ASCII is configured in an item on the reception side, a format invalid (S9F7) error occurs.

Conversion string format

The format is as follows: %[Flag][Field width].[Accuracy][h/l modification][Conversion string].

The following table indicates the details of each item.

■Flag

Flag	Description	
-	Outputs the conversion string justified to the right when the field width is specified.	
+	Outputs the conversion string with a leading positive or negative (+/-) sign.	
Blank	Outputs the conversion string with a leading space (single-byte space) for positive values, and aligns the conversion string with a negative sign for negative values.	
0	Fills areas corresponding to spaces with zeros for numerical output of a specified field width.	
#	#0	Adds a leading zero to octal data.
	#x, #X	Adds a leading '0x' to hexadecimal data.
	#f	Always adds a zero to outputs.

■Field Width

Field Width	Description
Numerical value	Specifies the output width. Left pads with spaces when the number of significant digits is less than the specified width. Ignores the width specification and outputs the significant digits of the data when the number of significant digits specified is greater than the specified width. Counts a decimal point as one place when the width is specified for a real number.

■h/l Modification

h/l Modification	Description
h	Indicates that the corresponding argument is "short int" or "unsigned short int" when the conversion string is d, i, o, u, x, or X.
l	Indicates that the corresponding argument is "long int" or "unsigned long int" when the conversion string is d, i, o, u, x, or X.

■Conversion String

Conversion String	Description
%s	Outputs the string as a character string.
%d, %i	Outputs the string in decimal format.
%u	Outputs the string in unsigned decimal format.
%o	Outputs the string in octal format.
%x, %X	Outputs the string in hexadecimal format. x is output as lower case, and X is output as upper case.
%f	Outputs the string as floating decimal point data in decimal format. The conversion result always includes a decimal point. Applicable when numbers do not continue after the decimal point as well. Determines the number of significant digits after the decimal point according to the specified accuracy. (Default: 6 digits)

Ex.

To send a control register value (binary value) in 5 digit (zero suppression) format, configure "%05d".

Precautions

To perform conversion in units of single characters, use %s. (%c cannot be used.)

7.15 Device Find/Replace

Series	SECS/GEM communication software		
	Non-GEM version	GEM version	GEM advanced version
MELSEC-Q series	<input type="radio"/>	<input type="radio"/>	<input type="radio"/>
MELSEC iQ-R series	<input type="radio"/>	<input type="radio"/>	<input type="radio"/>

This section explains the find and replace method for devices used in the project.

The following table shows the ranges of devices that can be found/replaced.

Device	Range of devices that can be found/replaced			
	MELSEC-Q series		MELSEC iQ-R series	
	Non-GEM version	GEM version, GEM advanced version	Non-GEM version (Ver.1.28E or later) ^{*1}	GEM version, GEM advanced version
B	B0 to BFFFF	B0 to BFFFF	B0 to B7FFFFFFF	B0 to BFFFF
D	D0 to D32767	D0 to D32767	D0 to D2147483647	D0 to D32767
M	M0 to M2147483647	M0 to M2147483647	M0 to M2147483647	M0 to M2147483647
R	R0 to R32767	R0 to R32767	R0 to R2147483647	R0 to R32767
W	W0 to W7FFF	W0 to W7FFF	W0 to W7FFFFFFF	W0 to W7FFF
X	X0 to X7FFF	X0 to X7FFF	X0 to X7FFF	X0 to X7FFF
Y	Y0 to Y7FFF	Y0 to Y7FFF	Y0 to Y7FFF	Y0 to Y7FFF
ZR	ZR0 to ZR2147483647	ZR0 to ZR2147483647	ZR0 to ZR2147483647	ZR0 to ZR2147483647

*1 When using Ver.1.27D or earlier, the ranges of devices that can be found/replaced are the same as those of non-GEM version of MELSEC-Q series.

Window

 [Setting]⇒[Device Find/Replace]

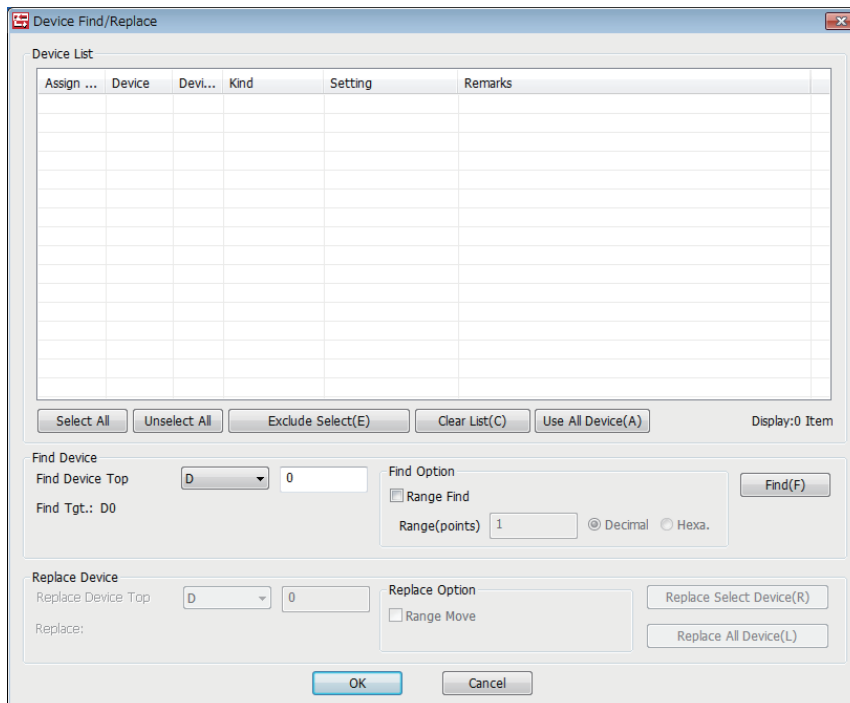

Displayed items

Item	Description
Device List	For details of items displayed in the device list, see the following reference.  Page 131 Device list

Item		Description
Find device	Find Device Top	Configure devices to be found.
	Find Tgt.	Displays the top of the device to be found.
Find Option	Range Find	Configure the search range.
	Range(points)	Configure the number of points to be found.
Replace Device	Replace Device Top	Configure devices to be replaced.
	Replace	Displays the top of the device to be replaced.
Replace Option	Range Move	Configure whether to replace the specified range. Replace the range from "Replace Device Top" to the number of points specified by "Range (points)".
[Select All] button		Select all rows in the device list.
[Unselect All] button		Unselect selections in the device list.
[Exclude Select] button		Delete selected rows from the device list.
[Clear List] button		Clear the device list.
[Use All Device] button		Display all devices in use in the project.
[Find] button		Search for devices that match the conditions of "Find device" and "Find Option".
[Replace Select Device] button		Replace the devices selected in the device list with the devices configured by "Replace Device" and "Replace Option".
[Replace All Device] button		Replace all devices selected in the device list with the devices configured by "Replace Device" and "Replace Option".

■ Device list

Item	Description	Notes
Assignment	Shared memory	Device allocated CPU shared memory
	I/O assignment	I/O assignment device
	No assignment	Device not assigned
Device	Device type and device number	—
Points	n	Consecutive quantity in use
Kind	Option Setting	By setting type
	Cache settings	
	Primary sending settings	
	Primary sending (interval) settings	
	Primary receiving settings	
	Secondary sending settings	
	Secondary receiving settings	
	Item settings	
	Item (selection register) settings	
	Command mapping settings (primary sending)	
	Command mapping settings (primary receiving)	
	Command mapping settings (secondary sending)	
	Command mapping settings (secondary receiving)	
	Variable settings ^{*1}	
	Variable cache settings ^{*1}	
	Event settings (sending) ^{*1}	
Event settings (receiving) ^{*1}		
GEM trigger information settings ^{*1}		
Model state notification settings ^{*1}		
Setting	Setting location	Setting item name, etc.
Remarks	Remarks	User comments, setting item explanations, etc.

*1 Can be used with the GEM version and GEM advanced version.

Display all devices in use

Display all devices in use in the project.

Replacement is not possible while devices are being displayed by this function.

Operating procedure

1. Click [Use All Device].

Device Search

Search for devices.

Search by device

Find specified devices.

Operating procedure

1. Configure "Find Device Top".
2. Click [Find].

Range search

Find devices in the specified range.

Operating procedure

1. Configure "Find Device Top".
2. Select the "Range Find" checkbox.
3. Configure "Range(points)".
4. Click [Find].

Replace Device

Replace found devices.

The correspondence of device types that can be replaced is as follows.

Before replacement	After replacement
B, M	B, M
X	B, M, X
Y	B, M, Y
D, R, W, ZR	D, R, W, ZR

Precautions

Devices cannot be replaced while all devices in use are displayed.

Replace by device

Replace specified devices.

Operating procedure

1. Select devices to be replaced in the Device List.
2. Configure "Replace Device Top".
3. Click the [Replace Select Device] or [Replace All Device] button.

Replacement by range

Group and replace consecutive devices.

Ex.

Replace (move) devices included in the range from D0 through D99 to D100 through D199.

Specifying a range and replacing can only be done when a range was specified and devices were found.

Operating procedure

1. Select devices to be replaced in the Device List.
2. Configure "Replace Device Top".
3. Select the "Range Move" checkbox.
4. Click the [Replace Select Device] or [Replace All Device] button.

Application of replacement results

Apply the results of device replacement to settings.

Operating procedure

1. In the "Device Find/Replace" screen, click the [OK] button.
2. In the confirmation screen, click [OK].

The replacement results are applied to the settings.

7.16 Log Output

Logs of device access with the programmable controller CPU registers and logs of SECS communication with the host can be output.

Log Output Setting

Configure the details of the logs to be output.

Common Setting

Series	SECS/GEM communication software		
	Non-GEM version	GEM version	GEM advanced version
MELSEC-Q series	<input type="radio"/>	<input type="radio"/>	<input type="radio"/>
MELSEC iQ-R series	<input type="radio"/>	<input type="radio"/>	<input type="radio"/>

Configure the common settings of the log output function.

Window

[Log] ⇒ [Log Output Setting] ⇒ [Common Setting] tab

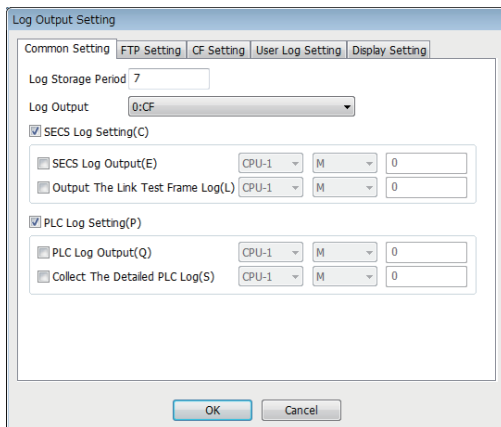

Displayed items

Item	Description
Log Storage Period	Configure the number of days to store log data. The log data is compiled into time-sliced files (in increments of hours), and saved for the specified number of days. A log outputted according to FTP settings to the FTP server is not deleted using the SECS/GEM communication software.
Log Output	Configure the log output destination. <ul style="list-style-type: none"> ■ MELSEC-Q series <ul style="list-style-type: none"> • 0: CF • 1: FTP ■ MELSEC iQ-R series <ul style="list-style-type: none"> • 0: SD • 1: FTP

Item		Description
SECS Log Setting	—	Select this checkbox to enable SECS log collection.
	SECS Log Output	Select this checkbox to control the start or end of log collection by a trigger from the programmable controller CPU. By specifying the trigger relay, SECS log collection will be started when the specified trigger relay turns ON and will be terminated when the trigger relay turns OFF. If this item is not configured, SECS communication logs are always collected from when the SECS/ GEM communication software starts.
	Output The Link Test Frame Log	Select this checkbox to save the host link test log in the SECS communication log. By specifying the trigger relay, the link test log with the host is output to the SECS communication log when the specified trigger relay turns ON and the log collection of link tests will be ended when the trigger relay turns OFF. When this item is not configured, the link test log is not output.
Programmable controller log setting	—	Select this checkbox to enable Programmable controller log collection.
	Programmable controller log output trigger	Select this checkbox to control the start or end of log collection by a trigger from the programmable controller CPU. By specifying the trigger relay, programmable controller log acquisition will be started when the specified trigger relay turns ON and will be terminated when the trigger relay turns OFF. When the detailed programmable controller CPU log will not be collected, only the status change of the device assigned to the sending request trigger relay and reception notification trigger relay of the message is recorded. If this item is not configured, programmable controller logs are always output from when the SECS/ GEM communication software starts.
	Collect The Detailed PLC Log	Select this checkbox to record the status change of all relays defined to the device assignment to the programmable controller log. By specifying the trigger relay, a detailed log is output to the programmable controller log when the specified trigger relay turns ON and will be terminated when the trigger relay turns OFF. When this item is not configured, the detailed programmable controller log is not output.

FTP Setting

Series	SECS/GEM communication software		
	Non-GEM version	GEM version	GEM advanced version
MELSEC-Q series	<input type="radio"/>	<input type="radio"/>	<input type="radio"/>
MELSEC iQ-R series	<input type="radio"/>	<input type="radio"/>	<input type="radio"/>

Configure the details for access the FTP server.

By using this setting, it is possible to output logs to the FTP server.

By outputting the logs to the FTP server, the number of writes to the memory card can be mitigated.

Window

 [Log] ⇒ [Log Output Setting] ⇒ [FTP Setting] tab

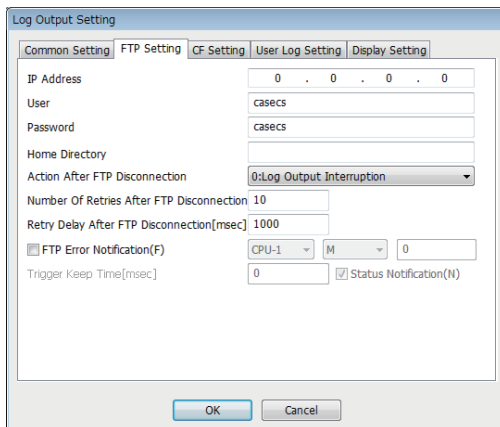

Displayed items

Item	Description
IP Address	Configure the IP address of the FTP server.
User	Configure the username of the FTP account.
Password	Configure the password of the FTP account.
Home Directory	Configure when the log will be output to a sub directory of the FTP account. When left blank, the logs are output under the home directory of the FTP account.
Action After FTP Disconnection	Select the operation when the connection with the FTP server has been disconnected. <ul style="list-style-type: none"> ■MELSEC-Q series • 0: Cancel log output: Logs are not output after FTP disconnection • 1: Output to CF: Logs are output to the CF card after FTP disconnection. ■MELSEC iQ-R series • 0: Cancel log output: Logs are not output after FTP disconnection • 1: Output to SD: Logs are output to the SD memory card after FTP disconnection.
Number of Retries After FTP Disconnection	Specify the number of retries to connect with the FTP server after FTP disconnection.
Retry Delay At FTP Disconnection	Specify the delay time for connection retries after FTP disconnection. The time is configured in increments of 10 (msec).
FTP Error Notification	Select this checkbox to turn ON the notification relay to report when log output to the FTP server has failed. Furthermore, configure the device to be used as the notification relay.
Trigger Keep Time	Hold the trigger relay for FTP error notification for the specified time. The time is configured in increments of 10 (msec).
State Notification	Select this checkbox to enable the trigger keep time. Furthermore, switch OFF the FTP error notification relay by the SECS/GEM communication software after reconnecting with the FTP server.

Precautions

- When a subdirectory has not been created in the FTP server, Action After FTP Disconnection results, even when an FTP subdirectory has been configured. However, the FTP error notification relay does not turn ON.
- When the MELSEC iQ-R series SECS/GEM communication software pre-installed model module is used, FTP log output uses the same network as SECS communication.

CF Setting

Series	SECS/GEM communication software		
	Non-GEM version	GEM version	GEM advanced version
MELSEC-Q series	○	○	○
MELSEC iQ-R series	—	—	—

Configure the storage destination of log files to be output to the CF card.

Window

 [Log] ⇒ [Log Output Setting] ⇒ [CF Setting] tab

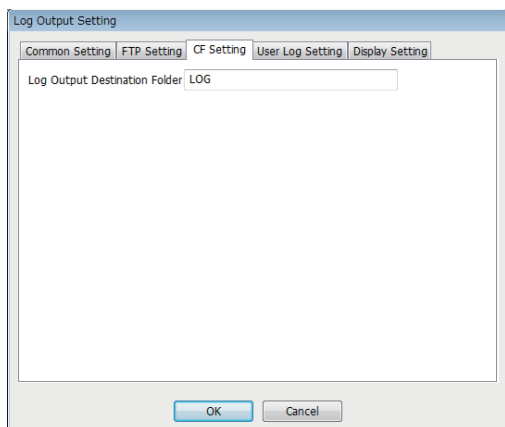

Displayed items

Item	Description
Log Output Destination Folder	Configure the home directory on the CF card to output the log files.

User Log Setting

Series	SECS/GEM communication software		
	Non-GEM version	GEM version	GEM advanced version
MELSEC-Q series	<input type="radio"/>	<input type="radio"/>	<input type="radio"/>
MELSEC iQ-R series	<input type="radio"/>	<input type="radio"/>	<input type="radio"/>

The User Log Settings tab allows you to output string data stored in the specified register as a log when the specified trigger switching ON is detected and browse data using the "Log View" screen in the setting tool.

Window

 [Log] ⇒ [Log Output Setting] ⇒ [User Log Setting] tab

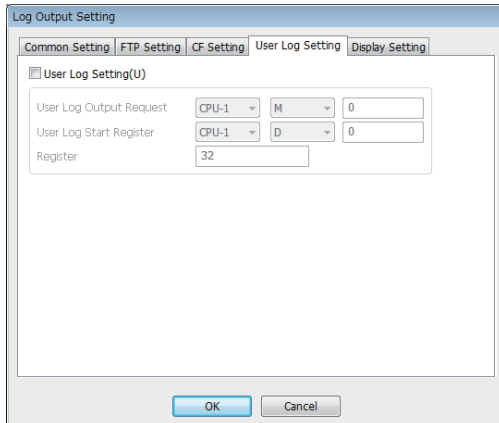

7

Displayed items

Item	Description
User Log Setting	— Select this checkbox to enable the user log setting.
User Log Output Request	Configure the user log output trigger. If the trigger is turned ON by the programmable controller CPU, and the log output ends, it is switched OFF by the SECS/GEM communication software.
User Log Start Register	Configure the start register where the data (ASCII strings) to be output to a log are to be stored.
Register Counts	Configure the number of registers (number of words) to be used for data storage counting. When the data does not satisfy this size, fill the terminating byte with NULL characters (0x00).

Display Setting

Series	SECS/GEM communication software		
	Non-GEM version	GEM version	GEM advanced version
MELSEC-Q series	<input type="radio"/>	<input type="radio"/>	<input type="radio"/>
MELSEC iQ-R series	<input type="radio"/>	<input type="radio"/>	<input type="radio"/>



Configure the details to display logs on a display.

Window

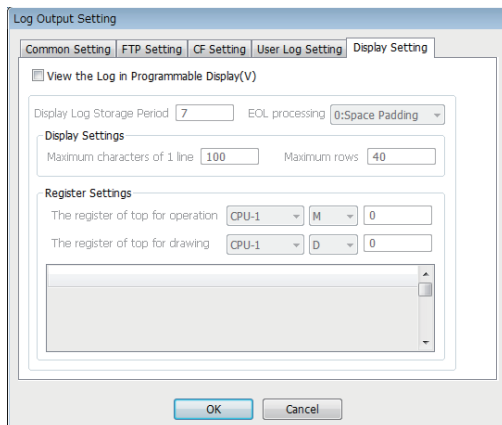
 [Log] ⇒ [Log Output Setting] ⇒ [Display Setting] tab



Displayed items

Item	Description
View the Log in Programmable Display	— Select this checkbox to view the log on the Programmable Display (GOT, etc.).
Display Log Storage Period	Configure the number of days to store log data to be displayed on the Programmable Display. The log data is compiled into time-sliced files (in increments of hours) and saved for the specified number of days.
EOL processing	Select the end-of-line processing when the number of characters per line is less than the maximum number of characters.
Maximum characters of 1 line	Configure the maximum number of characters to be displayed on one line on the Programmable Display.
Maximum rows	Configure the maximum number of rows to be displayed on one screen on the Programmable Display.
The register of top for operation (16bit)	Configure the device to be used for the operation register. The 16 continuous points from the configured device can be used as the operation register. Select "CPU-OWN" to specify an M device of the host station for the MELSEC-Q series SECS/GEM communication software pre-installed model module. For details on the operation register, see the following reference.  Page 149 View the Log on Display Device (GOT)
The register of top for drawing (5448Word)	Configure the device to be used for the display register. The 5448 continuous words from the configured device can be used as the display register. Select "CPU-OWN" to specify a D device of the host station for the MELSEC-Q series SECS/GEM communication software pre-installed model module. For details on the display register, see the following reference.  Page 149 View the Log on Display Device (GOT)

Precautions

- The display log file is saved to the SD memory card when the MELSEC iQ-R series SECS/GEM communication software pre-installed model module is being used.
- When a MELSEC-Q series SECS/GEM communication software pre-installed model module is being used, the display log file is saved to the directory configured by the following setting: [CF Setting] ⇒ [Log Output Destination Folder].
- When a device of this host station is used, it must be configured in advance at a row lower than a device of another station in the "I/O assignment" of the "Device Assignment Setting" screen.

Real Time Trace Setting

Series	SECS/GEM communication software		
	Non-GEM version	GEM version	GEM advanced version
MELSEC-Q series	○	○	○
MELSEC iQ-R series	○	○	○

The real-time trace function allows you to display SECS communication and device I/O information in real-time using a GOT.

Window

 [Log]⇒[Real Time Trace Setting]

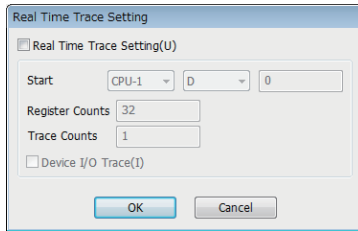

Displayed items

Item	Description
Real Time Trace Setting	—
Start	Select this checkbox to use the real time trace function.
Register Counts	Configure the start register where the data (ASCII strings) used for a real-time trace is to be stored.
Trace Counts	Configure the number of registers (number of words) to be used for data storage counting. When the output message does not satisfy the register count, NULL characters (0x00) are stored at the message end.
Device I/O Trace	Configure the number of real time traces to be output.
	Select this checkbox to display the device I/O information in real time.

Precautions

In case of multi-line output of real time trace, the total number of registers to be used is calculated as [Register Counts] × [Trace Counts].

Real Time Trace Output Message List

Example of output messages of communication trace

Type	Message example
Message sending	S1,F1 SEND 2008/10/21 17:06:05:100
Message reception	S1,F1 RECEIVE 2008/10/21 17:06:05:100
Message spool	S6,F11 SPOOL 2008/10/21 17:06:05:100
Message spool output	S66,F115 SPOOL OUT 2008/10/21 17:06:05:100
CA-SECS start-up	CA-SECS READY 2008/10/21 17:06:05:100
Connection (TCP/IP)	CONNECT 2008/10/21 17:06:05:100
Disconnection	DISCONNECT 2008/10/21 17:06:05:100
Communication established (COMMUNICATING)	COMMUNICATING 2008/10/21 17:06:05:100
ONLINE	ONLINE 2008/10/21 17:06:05:100
OFFLINE	OFFLINE 2008/10/21 17:06:05:100
Spool start	SPOOL ACTIVE 2008/10/21 17:06:05:100
Spool stop	SPOOL INACTIVE 2008/10/21 17:06:05:100

■ Example of output messages of device I/O trace

Type	Message example		
Device relay ON	M101	ON(EQ)	2008/10/21 17:06:05:100
CA-SECS relay ON	M1024	ON(CA-SECS)	2008/10/21 17:06:05:100
Device relay OFF	M5	OFF(EQ)	2008/10/21 17:06:05:100
CA-SECS relay OFF	M28	OFF(CA-SECS)	2008/10/21 17:06:05:100
Registry read error	D2049	READ ERROR	2008/10/21 17:06:05:100
Registry write error	D16	WRITE ERROR	2008/10/21 17:06:05:100
Handshake error	M512	HANDSHAKE ERROR	2008/10/21 17:06:05:100

Log View

Series	SECS/GEM communication software		
	Non-GEM version	GEM version	GEM advanced version
MELSEC-Q series	<input type="radio"/>	<input type="radio"/>	<input type="radio"/>
MELSEC iQ-R series	<input type="radio"/>	<input type="radio"/>	<input type="radio"/>

Display the log acquired from the SECS/GEM communication software pre-installed model module.

Window

 [Log]⇒[Log View]

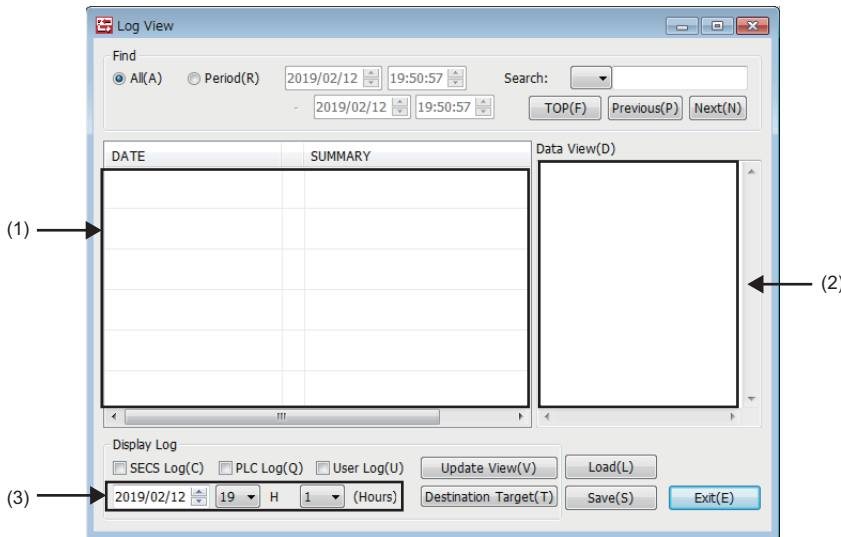

Displayed items

Item	Description	
Find	All	Select to find all logs.
	Period	Select to specify the period for search.
	Search conditions	To find for log data that matches conditions, either select from the pulldown lists of the search conditions or enter character strings, and then click the [TOP], [Previous], or [Next] button.
	[TOP] button	Move to the start of the search target.
	[Previous] button	Move to the previous search target.
	[Next] button	Move to the next search target.
(1)Log list	Displays log data as a list. If the title "DATE" is clicked, the data is sorted by date in ascending or descending order. If data in the Log list is right clicked while SECS logs or user logs are displayed, the content displayed in the Data View can be selected by a shortcut menu.	
(2)Data View	Displays content of log data.	
Display Log	SECS Log	Select this checkbox to display SECS logs.
	Programmable controller log	Select this checkbox to display programmable controller logs.
	User Log	Select this checkbox to display user logs.
	(3)Time specification	Specify the date, hour, and minute of logs to be displayed.
	[Update View] button	Import and display the updated log data from the SECS/GEM communication software pre-installed model module.
	[Destination Target] button	Configure the SECS/GEM communication software pre-installed model module to import log data.
[Load] button	Open a saved log data file.	

Item	Description
[Save] button	<p>Save the log data currently displayed.</p> <p>The following file formats can be selected.</p> <ul style="list-style-type: none"> • Binary log file (file extension: .log): The binary log data is saved as it is. Use the [Load] button on the screen to view the log later. • Text log file (file extension: .txt): The log data is configured as a list and saved as text data. The text data can be opened and browsed with any text editor.

Log Types

Display the correspondence of the symbols displayed in log data and log types.

Symbol	Description	Log Types
O(Output)	Log for which the SECS/GEM communication software changed the relay status	Programmable controller log
I(Input)	Log for which the programmable controller CPU changed the relay status	Programmable controller log
S(Send)	Message sending log	SECS Log
R(Receive)	Message reception log	SECS Log
U(User)	User Log	User Log
M(Management)	Log to display the SECS status by the SECS/GEM communication software	SECS status message
E(Error)	Error Log	Error Log

SECS Log

The following section shows the display of SUMMARY.

Item	Description
S	Stream number
F	Function number
Dev	Device ID
No.	Line number
LEN	Byte length

If an SECS log is selected in the Log list, the content of the SECS communication log appears in the Data View.

The following section explains the operations of the Log list.

■Summary display

Provides a summary view showing the data header in binary in the Data View.

 Right-click⇒Shortcut menu[Summary]

■Dump display

Dumps the SECS communication data content in the Data View.

 Right-click⇒Shortcut menu[Dump]

■Text display

Shows the SECS communication data content in the Data View in a tree structure.

 Right-click⇒Shortcut menu[Text]

Programmable controller log

The following section shows the display of SUMMARY.

Item	Description
CPU	CPU No.
Ch	Channel number (0: 0xFF, other than 0: Channel number for communication function)
Ex	STA#
Dev	Device type
No	Device number and status (ON/OFF display)

If a programmable controller log is selected in the Log list, the content of the I/O log appears in the Data View.

User Log

The following section shows the display of SUMMARY.

Item	Description
TYPE	Log type (TEXT: Text log, BINARY: Binary log)
LEN	Byte length

If a user log is selected in the Log list, the content of the user log appears in the Data View.

The following section explains the operations of the Log list.

■Summary display

Provides a summary view showing the data header in binary in the Data View.

 Right-click⇒Shortcut menu[Summary]

■Dump display

Dumps the user log content stored in the specified register in the Data View.

 Right-click⇒Shortcut menu[Dump]

■Text display

Displays the user log content stored in the specified register in the Data field.

Even when the data is long, a new line will not be created. A new line appears when "CR + LF" exists within the data.

 Right-click⇒Shortcut menu[Text]

SECS status message

Log to display the SECS status managed by the SECS/GEM communication software.

The following table shows the item content to be displayed.

Message	Description	Notes
CIMREADY	CIM control is ready.	Output is enabled only when the SECS communication log output trigger is not used (SECS logs are always acquired).
CONNECT(Selected)	The line is connected.	Indicates a Selected state for HSMS communication.
DISCONNECT(NotSelected)	Disconnection was detected.	Indicates a Not Selected state for HSMS communication.
Communicating	Communication is established.	Indicates that the S1F13 transaction was successful.
NotCommunicating	Communication is disconnected.	—
ON-LINE	The mode transitioned to online.	—
OFF-LINE	The mode transitioned to offline.	—
SpoolEnabled	The spool function is configured to enabled.	The ON status of the Enable spooling relay is detected.
SpoolDisabled	The spool function is configured to disabled.	The OFF status of the Enable spooling relay is detected.
SpoolActive	Spooling has started.	—
SpoolInactive	Spooling has stopped.	—
SpoolTransmitStart	Spool transmission has started.	Triggered by S6F23 (Spooled data request) reception.
SpoolTransmitFailure	An error occurred during spool transmission, resulting in transmission cancellation.	T3 timeout, line disconnection, etc.
SpoolTransmitComplete	All spool transmission has been completed.	—
PurgeSpool	The spool was purged.	Triggered by S6F23 (Spooled data request) reception or the use of the spool data discard trigger.
ControllerClock-Changed	The controller time was changed.	—

Precautions

The order of log output before and after a SECS status message may differ from the actual time series.

Error Log

Error logs are displayed in red characters.

The following table shows the details of error messages.

■Programmable controller CPU error messages

Message	Description	Notes
READ_ERR(error code)	Data was not read.	An error code is added at the end of the message.
WRITE_ERR(error code)	Data was not written.	An error code is added at the end of the message.
Assignment invalid	An area not defined in device assignments was specified in an item storage register, etc.	—
Response monitoring timeout	There was no programmable controller CPU response (OFF) to a SECS/GEM communication software trigger notification (ON) within the response monitoring timer setting, causing the trigger to be forcibly turned OFF.	When a handshake is specified for the reception notification trigger, SECS error notification, etc.

■SECS error messages

Message	Description	Notes
DM reception error	Reception error	<ul style="list-style-type: none"> • HSMS: Data with unknown communication level • SECS1: Checksum error^{*1} • SECS2: Full-queue error
DM sending error	DM was not sent.	—
CM sending error	CM sending error	—
Sending DM creation failed (1)	Initialization failed.	CPU reset is recommended.
Sending DM creation failed (2)	Creation failed.	This error also applies to the register read error, which is often caused by an incorrect register assignment setting.
DM sending failure	Sending Failure	The SECS/GEM communication software may be under load.
Secondary request timeout	After reception of a primary message, no secondary sending request trigger was detected within the response monitoring timer setting.	This error is not output for a secondary reception notification handshake timeout.
Reception data format error	The reception data includes an incorrect SECS header.	—
Data length invalid	Reception error (too long)	S9F11 sending
Incorrect format	Incorrect format	S9F7 sending, the message received from the host is different from the one configured in terms of item type, list structure, or data length.
Incorrect device ID	Incorrect device ID	S9F1 sending
Undefined SF code	Undefined SF code	S9F3/F5 sending, a message is regarded as an undefined message if the reception notification trigger option is not selected in the Message Property window.
Data error	Reception data error	This error also applies to the register write error, which is often caused by an incorrect register assignment setting.
Full SECS queue	A memory acquisition error occurred when creating a reception data storage buffer	The CPU must be reset.
Full reception queue	Full reception queue	This error may also occur even for single transactions when the software continuously receives the same message and fails to establish handshaking.
Full transmission queue	Full transmission queue	<ul style="list-style-type: none"> • This error may also occur even for multi-transactions if sending processing is delayed due to too much load. • No spooling is available.
Full multi-transaction queue	The multi-transaction queue for sending is full.	—
Message discarded because no communication has been established	The requested sending message was discarded because communication has not been established.	An attempt was made to send a message other than S1F13 before communication was established.
Message discarded because it is out of spool scope	A non-spooled sending message requested during spooling was discarded.	—
Message discarded due to full spool	A spooled sending message requested during spooling was discarded because the spool is full.	<ul style="list-style-type: none"> • The spool must be transferred or discarded. • This error is not output during overwriting.

Message	Description	Notes
Message discarded because spooling is disabled	A spooled sending message requested during spooling was discarded because spooling is disabled.	Check the Enable spooling relay. Note that the Enable spooling relay can be configured only by a non-GEM version.
Cyclic measurement cancelled	Although the cyclic message sending request trigger is ON, sending was cancelled due to an offline status, etc.	<ul style="list-style-type: none"> Offline, line disconnected, spooling in progress (excluding cases where the message is a spooled message) An error is output periodically until either the status changes to sending enabled or the request trigger is turned OFF. (Measurement resumes once the status changes to sending enabled.)
Sending cancelled due to offline (1)	Although a message sending request trigger was detected, sending was not performed because the status was offline.	<ul style="list-style-type: none"> An attempt was made to send a message other than S1F1 while offline. Cyclic messages are excluded.
Sending cancelled due to offline (2)	Although a message sending request trigger was detected, a message was not created since the status was offline and the message is a non-spooled message.	<ul style="list-style-type: none"> When the "Spool during offline" option is enabled Cyclic messages are excluded.
Sending cancelled due to offline (3)	Although a message sending request trigger was detected, a message was not created because the status was offline and the spooling is disabled.	<ul style="list-style-type: none"> When the "Spool during offline" option is enabled Cyclic messages are excluded.
Sending cancelled due to line disconnection (1)	Although a message sending request trigger was detected, the message was not sent because the line is disconnected.	This error is for secondary messages only.
Sending cancelled due to line disconnection (2)	Although a message sending request trigger was detected, the message was not created because the line is disconnected and the message is a non-spooled message.	Cyclic messages are excluded.
Sending cancelled due to line disconnection (3)	Although a message sending request trigger was detected, a message was not created because the line is disconnected and spooling is disabled.	Cyclic messages are excluded.
Dialog interrupted due to dialog violation	A message with the response message monitoring (dialog) setting was sent, but a notification was received from the host regarding a message other than the one subject to monitoring.	The output SF is the one of the sending message with the dialog setting.
Dialog monitoring target	This error is output in combination with "Dialog interrupted due to dialog violation" or "T9 timeout error".	The SF output is the one of the monitoring target configured to dialog.
T1 timeout error	T1 timeout	Only for SECS-I
T2 timeout error	T2 timeout	Only for SECS-I
T3 timeout error	T3 timeout	S9F9 sending
T4 timeout error	T4 timeout	Only for SECS-I
T6 timeout error	T6 timeout	Only for HSMS
T7 timeout error	T7 timeout	Only for HSMS
T8 timeout error	T8 timeout	Only for HSMS
T9 timeout error	T9 timeout	The output SF is the one of the sending message with the dialog setting.
Reception notification trigger not set	Although there is a format definition, notification of message reception is not possible since the reception notification trigger is disabled.	For primary messages, an abort is returned after detection of this error. For secondary messages, this error is not detected.
Unclear secondary reception	A secondary message that is not transaction-monitored by the SECS/GEM communication software has been received.	<ul style="list-style-type: none"> A T3 timeout already occurred for the secondary message. The SF code does not match the code of the sent primary message (the stream is different; the function is not primary message +1). A response was returned from the host for a primary message without a wait bit. The host sent a message with even-numbered functions as a primary message.
Abort reception (transfer continued)* ²	An abort message was received during spool transmission.	Issued when the "Abort receipt during spool transmission" setting of Common Spool Setting is configured to "Skip and continue transfer".
Abort reception (transfer interrupted)* ²	An abort message was received during spool transmission.	Issued when the "Abort receipt during spool transmission" setting of Common Spool Setting is configured to "Retain message and cancel transfer".

*1 Displayed for only the MELSEC-Q series SECS/GEM communication software pre-installed model module.

*2 Appears in the non-GEM version only.

View the Log on Display Device (GOT)

Series	SECS/GEM communication software		
	Non-GEM version	GEM version	GEM advanced version
MELSEC-Q series	<input type="radio"/>	<input type="radio"/>	<input type="radio"/>
MELSEC iQ-R series	<input type="radio"/>	<input type="radio"/>	<input type="radio"/>

Using a register, display logs saved to the memory card on the display.

Since the data has been displayed via a register, you do not need to configure the script in the Programmable Display.

If the SECS/GEM communication software receives an operation instruction by an operation register, the logs are deployed to the display register.

To display logs on the display, select the checkbox of "View the log in Programmable Display" in the Log Output Settings.

Configure the devices used by the operation register and display register in the device assignment settings.

The following image shows when a log is displayed on a GOT.

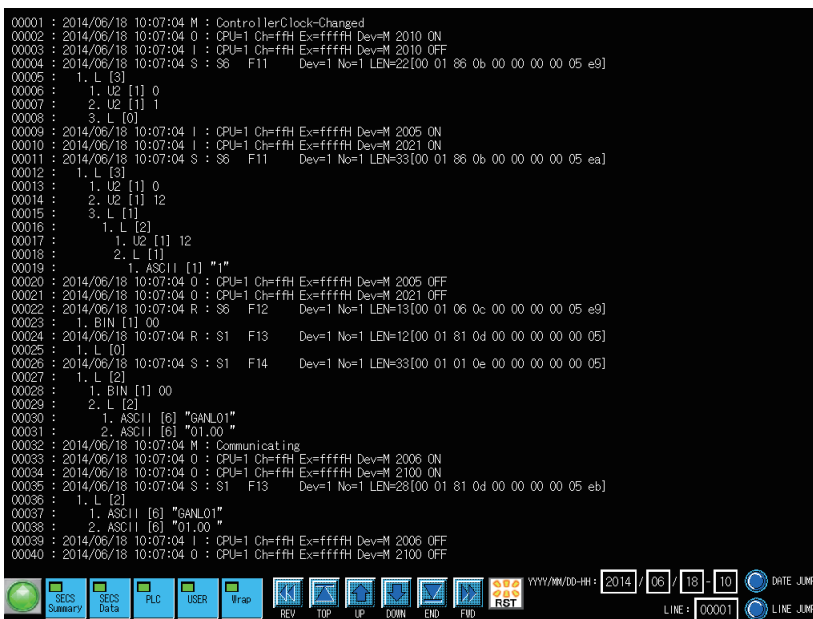

Precautions

To display a log on a GOT, a screen must be created on the GOT in advance.

For the GOT drawing method, see the following reference.

GT Designer3 Version1 Screen Design Manual (Fundamentals)

GT Designer3 Version1 Screen Design Manual (Functions)

Operation Register List

No.	Name	Description	Programmable Display Setting Operation
1	Prev_Time	ON = Move to the previous hour.	Bit set ^{*1}
2	Next_Time	ON = Move to the next hour.	
3	Prev_Page	ON = Move to the previous page.	
4	Next_Page	ON = Move to the next page.	
5	Top_Line	ON = Move to the top line.	
6	End_Line	ON = Move to the end line.	
7	Jump_Data	ON = Move to the specified date and time.	
8	Jump_Line	ON = Move to the specified line.	

No.	Name	Description	Programmable Display Setting Operation
9	SECS_S_Mask	ON = Display the target log. OFF = Do not display the target log.	Bit invert
10	SECS_D_Mask		
11	PLC_Mask		
12	USER_Mask		
13	WRAP	ON = Wrap at the maximum number of characters. OFF = Do not wrap at the maximum number of characters.	
14	CLEAR	ON = Clear the screen.	Bit set ^{*1}
15	Info	ON: Operation error (when there is no move-destination file) OFF: Operation normal	Reference ^{*2}
16	Not used	Not used	Not used

*1 Turned OFF by the SECS/GEM communication software.

*2 Switched ON/OFF by the SECS/GEM communication software.

Display Register List

No.	Name	Description	Size (Word)	Programmable Display Setting Operation
1	Log_Year	Enter the year of the log to be displayed. (YYYY: 0000 to 9999)	1	Read/Write ^{*1}
2	Log_Month	Enter the month of the log to be displayed. (MM: 01 to 12)	1	
3	Log_Day	Enter the day of the log to be displayed. (DD: 01 to 31)	1	
4	Log_Hour	Enter the time of the log to be displayed. (HH: 00 to 23)	1	
5	Line_No	Enter the line number of the jump destination.	2	Read/Write ^{*2}
6	Not used	Not used	2	Not used
7	Log_Area	Start register of the log display area.	5440	Read ^{*3}

*1 Data format is unsigned BIN16.

*2 Data format is unsigned BIN32.

*3 Display by an ASCII string.

Precautions

Log_Area (log display area) does not support the new line character in text display objects.

Set only single line text in each text display object.

Ex.

Ex.) Display text is 100 characters, 40 lines and start is from D0 device.

Text display objects that can display 100 characters are arranged as 40 units.

The text display objects that can display 100 characters will be arranged into 40 items. Each register will be assigned consecutively as D0, D50, D100, D150...D1800, D1850, D1900, and D1950.

Considerations when the log output function is used

- If a large volume of logs are collected in a short interval, the control function performance of the SECS/GEM communication software may be affected. Fully take this precaution into account when collecting log data during normal operation.
- If logs are referenced, the control function performance of the SECS/GEM communication software may be affected. It is recommended to terminate log data collection (turn OFF the output trigger relay) before referencing log data.
- If logs are collected during operation of the SECS/GEM communication software, log collection may fail. In such cases, collect the logs again.
- Log data is stored on the memory card. See the log on the memory card.
- Log writing occurs at an interval of 10 seconds. Logs are not output just after operation.

Considerations when switching the power ON or OFF

Never switch the power supply of the SECS/GEM communication software pre-installed model module OFF during log output. Perform one of the following actions before switching OFF the power supply.

- Make sure that the log output bit is OFF.
- Unmount the SD card of the MELSEC iQ-R series SECS/GEM communication software pre-installed model module (by moving the Mode switch of the MELSEC iQ-R series SECS/GEM communication software pre-installed model module from the center to SELECT for 3 seconds or more)
- Move the Mode switch of the MELSEC-Q series SECS/GEM communication software pre-installed model module from RUN to STOP, and then wait 3 seconds or more

To prevent corruption of logs and spooling files, all file writing is stopped.

Furthermore, perform the following actions before switching ON the power supply.

- Return the Mode switch of the MELSEC iQ-R series SECS/GEM communication software pre-installed model module to the center.
- Return the Mode switch of the MELSEC-Q series SECS/GEM communication software pre-installed model module to RUN.

Operation may be affected because there are limits on file access during start-up.

7.17 Documentation

Series	SECS/GEM communication software		
	Non-GEM version	GEM version	GEM advanced version
MELSEC-Q series	<input type="radio"/>	—	<input type="radio"/>
MELSEC iQ-R series	<input type="radio"/>	<input type="radio"/>	<input type="radio"/>

The definition information of the SECS/GEM communication software is output as electronic data.

You can check the SECS message definitions, device assignment definitions, and other setting content as a list.

Window

 [Documentation]⇒[Documentation]

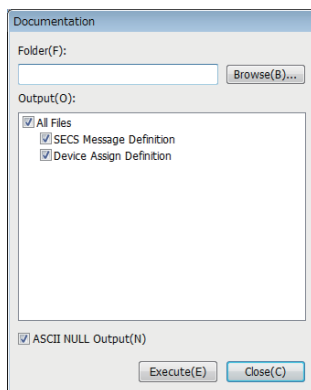



Displayed items

Item	Description
Folder	Specify the folder to output the file.
Output	Select the data to output as a file.
ASCII NULL output	Select this checkbox to output device assignment definitions when one word was added to the NULL stopper register for an ASCII-format item for which an even number is configured for the data count.



Non-GEM version

The following files can be output by a non-GEM version.

File name	Form at	Description	Notes
SECS Message Definition	csv	Output the content of SECS messages as a list.	For more details, see the following reference.  Page 154 SECS Message Definition
Device assignment definition	csv	Output devices that have undergone device assignment definition as a list.	For more details, see the following reference.  Page 155 Device Assignment Definition



GEM version

The following files can be output by a GEM version.

File name	Form at	Description	Notes
SECS Message Definition	csv	Output the content of SECS messages as a list.	For more details, see the following reference.  Page 154 SECS Message Definition
Device assignment definition	csv	Output devices that have undergone device assignment definition as a list.	For more details, see the following reference.  Page 155 Device Assignment Definition

GEM advanced version

The following files can be output by an advanced GEM version.

File name	Format	Description	Notes
GEM settings	csv	Output GEM settings as a list.	—
GEM Compliant Table	csv	Output GEM performance definitions as a list.	—
Alarm Definition	csv	Output alarms as a list.	Contents same as GEMALM.CSV.
Spool Definition	csv	Output spools as a list.	Contents same as GEMSPL.CSV.
Variable Definition	csv	Output variables as a list.	Contents same as VALLST.CSV.
Report Definition	csv	Output reports as a list.	Contents same as RPTLST.CSV.
Event Definition	csv	Output events as a list.	Contents same as EVTLST.CSV.
Limit Attribute Definition	csv	Output limit attributes as a list.	Contents same as LMTLST.CSV.
Communication State Model	doc	Output a communication state model diagram.	Copy the file created in advance.
Control State Model	doc	Output a control state model diagram.	Copy the file created in advance.
Processing State Model	doc	Output a processing state model diagram.	Copy the file created in advance.
Alarm State Model	doc	Output an alarm state model diagram.	Copy the file created in advance.
Spool State Model	doc	Output a spool state model diagram.	Copy the file created in advance.
Limit State Model	doc	Output a limit state model diagram.	Copy the file created in advance.
SECS Message Definition	csv	Output the content of SECS messages as a list.	For more details, see the following reference.  Page 154 SECS Message Definition
Device Assignment Definition	csv	Output devices that have undergone device assignment definition as a list.	For more details, see the following reference.  Page 155 Device Assignment Definition

SECS Message Definition

Output SECS messages created in transaction definitions to a .csv format file.

The following section describes the keywords listed in each line of the file.

Keyword	Description
TR	Transaction information
PM	Primary message information
SM	Secondary message information
IT	Item information

Device Assignment Definition

Output devices configured by device assignment as a .csv file.

Because the files are sorted in order of device number before output, it is possible to check for duplicate settings.

The following section describes the keywords listed in each line of the file.

Keyword	Description
PM-SND	Control relay for sending request trigger of the primary message
PM-RCV	Control relay for reception notification trigger of the primary message
SM-SND	Control relay for sending request trigger of the secondary message
SM-RCV	Control relay for reception notification of the secondary message
IT	Control register for item information screen
SC	Scenario Start Request Trigger
OP	Trigger setting of option settings
CM-PM-SND	Primary message sending request trigger defined by the mapping setting function
CM-PM-RCV	Primary message reception notification trigger defined by the mapping setting function
CM-SM-SND	Secondary message sending request trigger defined by the mapping setting function
CM-SM-RCV	Secondary message reception notification trigger defined by the mapping setting function
PM-SND-INTREG	Primary message interval storage register
CM-IT	Offset value of the mapping setting function
VAL ^{*1}	Storage register of variable
GEMTRG ^{*1}	Control relay of each GEM function
STSMDL-COM ^{*1}	State notification relay of the communication state model
STSMDL-CNT ^{*1}	State notification relay of the control state model
STSMDL-PRC ^{*1}	State notification relay of the processing state model
STSMDL-SPL ^{*1}	State notification relay of the spool state model
CCH ^{*1}	Register defined by variable cache settings
EVT-SND ^{*1}	Control relay for sending request trigger of event definition
EVT-RCV ^{*1}	Control relay for reception notification trigger of event definition

*1 Output by the GEM version and GEM advanced version.

8 GEM Compliant Functions

8.1 GEM PERFORMANCE DEFINITION SETTING

Series	SECS/GEM communication software		
	Non-GEM version	GEM version	GEM advanced version
MELSEC-Q series	—	○	○
MELSEC iQ-R series	—	○	○

Configure the GEM performance definition conditions implemented by the SECS/GEM communication software. Select the checkboxes of performances to be implemented at the "GEM Performance Definition" screen.

Window

 Main screen ⇨ [GEM Performance] tab

Displayed items

■ Messages used in basic requirements of GEM

Performance	Used message	Message name	Direction	Notes
Communication state model	—	—	—	See S1F13/F14 scenario started by host, communication establishment
Control state model	—	—	—	See control (started by operator), control (started by host)
	S6F11/12	Event Report Send/Event Report Acknowledge	H←E	Transition of control state
Device process state	S6F11/12	Event Report Send/Event Report Acknowledge	H←E	Process start/end, process state change
S1F13/F14 scenario started by host	S1F13/14	Establish Communication Request/ Establish Communication Request Acknowledge	H→E	—
Event notification	S6F5/6	Multi-Block Data Send Inquire/Multi-Block Grant	H←E	—
	S6F11/12	Event Report Send/Event Report Acknowledge	H←E	—
	S6F15/16	Event Report Request/Event Report Data	H→E	—
Online check	S1F1/2	Are You There Request/On Line Data	H→E	—

Performance	Used message	Message name	Direction	Notes
Error message	S9F1	Unrecognized Device ID	H←E	Automatic SECS/GEM communication software transmission upon detection
	S9F3	Unrecognized Stream Type	H←E	Automatic SECS/GEM communication software transmission upon detection
	S9F5	Unrecognized Function Type	H←E	Automatic SECS/GEM communication software transmission upon detection
	S9F7	Illegal Data	H←E	Automatic SECS/GEM communication software transmission upon detection
	S9F9	Transaction Timer Timeout	H←E	Automatic SECS/GEM communication software transmission upon detection
	S9F13	Conversation Timeout	H←E	Defined by user and transmitted upon request from ladder program
Control (started by operator)	S1F1/2	Are You There Request/On Line Data	H←E	Implements Operator offline setting; operator local switching
Documentation	—	—	—	Supported by GEM advanced version

■ Messages used in additional GEM performance

Performance	Used message	Message name	Direction	Notes
Communication establishment	S1F13/14	Establish Communication Request/ Establish Communication Request Acknowledge	H←E	—
Dynamic event report setting change	S2F33/34	Define Report/Define Report Acknowledge	H→E	—
	S2F35/36	Link Event Report/Link Event Report Acknowledge	H→E	—
	S2F37/38	Enable/Disable Event Report/Enable/ Disable Event Report Acknowledge	H→E	—
	S2F39/40	Multi-Block Inquire/Multi-Block Grant	H←E	—
Variable data acquisition	S6F19/20	Individual Report Request/Individual Report Data	H→E	—
Trace data acquisition	S2F23/24	Trace Initialize Send/Trace Initialize Acknowledge	H→E	Supported by GEM advanced version
	S6F1/2	Trace Data Send/Trace Data Acknowledge	H←E	Supported by GEM advanced version
State data acquisition	S1F3/4	Selected Equipment Status Request/ Selected Equipment Status Data	H→E	—
	S1F11/12	Status Variable Namelist Request/ Status Variable Namelist Reply	H→E	—
Alarm management	S5F1/2	Alarm Report Send/Alarm Report Acknowledge	H←E	—
	S5F3/4	Enable/Disable Alarm Send/Enable/ Disable Alarm Acknowledge	H→E	—
	S5F5/6	List Alarm Request/List Alarm Data	H→E	—
	S5F7/8	List Enabled Alarm Request/List Enabled Alarm Data	H→E	Supported by MELSEC-Q series SECS/ GEM communication software pre-installed model module
	S6F11/12	Event Report Send/Event Report Acknowledge	H←E	—
Remote control	—	—	—	Requires message definition by user
Device constant	S2F13/14	Equipment Constant Request/ Equipment Constant Data	H→E	—
	S2F15/16	New Equipment Constant Send/New Equipment Constant Acknowledge	H→E	—
	S2F29/30	Equipment Constant Namelist Request/Equipment Constant Namelist	H→E	—
	S6F11/12	Event Report Send/Event Report Acknowledge	H←E	—

Performance	Used message	Message name	Direction	Notes
Process recipe management	S7F17/18	Delete Process Program Send/Delete Process Program Acknowledge	H→E	Supported by GEM advanced version
	S7F19/20	Current EPPD Request/Current EPPD Data	H→E	Supported by GEM advanced version
	S7F23/24	Formatted Process Program Send/Formatted Process Program Acknowledge	H→E	Requires message definition by user
Material transfer	S6F11/12	Event Report Send/Event Report Acknowledge	H←E	Transport event
Device terminal service	—	—	—	Requires message definition by user
Clock	S2F17/18	Date and Time Request/Date and Time Data	H↔E	—
	S2F31/32	Date and Time Set Request/Date and Time Set Acknowledge	H→E	—
Limit monitoring	S2F45/46	Define Variable Limit Attributes/Variable Limit Attribute Acknowledge	H→E	Supported by GEM advanced version
	S2F47/48	Variable Limit Attribute Request/Variable Limit Attributes Send	H→E	Supported by GEM advanced version
	S6F11/12	Event Report Send/Event Report Acknowledge	H←E	Inter-area transition event
Spooling	S2F43/44	Reset Spooling Streams and Functions/Reset Spooling Acknowledge	H→E	—
	S6F23/24	Request Spooled Data/Request Spooled Data Acknowledgment Send	H→E	—
	S6F11/12	Event Report Send/Event Report Acknowledge	H←E	Spooling stopped//transfer failure
Control (started by the host)	S1F15/16	Request OFF-LINE/OFF-LINE Acknowledge	H→E	—
	S1F17/18	Request ON-LINE/ON-LINE Acknowledge	H→E	—

8.2 About State Model Management

Series	SECS/GEM communication software		
	Non-GEM version	GEM version	GEM advanced version
MELSEC-Q series	—	○	○
MELSEC iQ-R series	—	○	○

Of the state models required by GEM, communication state, control state, and spooling state are managed automatically by the SECS/GEM communication software.





Therefore, define the notification destination register of the default state (state arbitrarily definable by the equipment) and state number for the setting content.

The current processing state of the equipment must be managed by the programmable controller CPU by the processing state model, and, in addition to the above, the setting content must define the notification content for changes to the SECS/GEM communication software.

Regardless of the state, the operation of the state model must be understood. The following section provides explanatory notes for the state model.

Check the transfer operation of each model by each item.

For the message content and scenario operations, see the GEM standards document.

State Model	Description
	State name
	Transition destination
	Initial state
	Historical selector (return to previous state)
	Conditional Selector

8.3 GEM MODEL STATE NOTIFICATION SETTING

Series	SECS/GEM communication software		
	Non-GEM version	GEM version	GEM advanced version
MELSEC-Q series	—	○	○
MELSEC iQ-R series	—	○	○

The model state notification setting is used to display the model state, such as the communication state or control state, on an external display device such as a GOT.

Each state is assigned to a relay device.

To enable this function, select [GEM Function]⇒[Model State Notification].

Window

 [GEMFunction] ⇒ [Model State Notification Settings]

Displayed items

Item	Description
Communication state model	Select this checkbox to report the state of the communication state model. The state is reported using 8 relays from the start.
Control State Model	Select this checkbox to report the state of the control state model. The state is reported using 8 relays from the start.
Processing State Model	Select this checkbox to report the state of the processing state model. The state is reported using 8 relays from the start. This model state can be output processing unit-wise as far as the processing state is concerned No. of relay devices equal to (8 items from the top × no. of processing units) are used, based on the no. of processing units set in the "Processing State Settings" screen.
Spooling state model	Select this checkbox to report the state of the spooling state model. The state is reported using 8 relays from the start.

Details of state notification relays

■ State notification relays used in communication state model

Relay (from top)	Value
1	DISABLED (Communication disabled)
2	ENABLED(Communication enabled)
3	NOT COMMUNICATING Communication interrupted)
4	WAIT CR FROM HOST
5	WAIT CRA
6	WAIT DELAY
7	COMMUNICATING (Communication in progress)
8	Reserved

■ State notification relays used in control state model

Relay (from top)	Value
1	OFF-LINE
2	EQUIPMENT OFF-LINE
3	ATTEMPT ON-LINE
4	HOST OFF-LINE
5	ON-LINE
6	LOCAL
7	REMOTE
8	Reserved

■ State notification relays used in processing state model

Relay (from top)	Value
1	IDLE
2	PROCESSING ACTIVE
3	PROCESS
4	SETUP
5	READY
6	EXECUTING
7	PAUSE
8	Reserved

■ State notification relays used in spooling state model

Relay (from top)	Value
1	SPOOL INACTIVE(Spool stopped)
2	SPOOL ACTIVE(Spool activity)
3	NO SPOOL OUTPUT
4	SPOOL OUTPUT(Spool output)
5	TRANSMIT SPOOL
6	PURGE SPOOL
7	SPOOL NOT FULL
8	SPOOL FULL(Spool full)

8.4 COMMUNICATION STATE MODEL MANAGEMENT

Series	SECS/GEM communication software		
	Non-GEM version	GEM version	GEM advanced version
MELSEC-Q series	—	○	○
MELSEC iQ-R series	—	○	○

Communication link state between host and SECS-II level is managed using the following state model.

Communication between the device and the host is established once the state becomes COMMUNICATING (communication in progress).

The communication state model is completely managed by the SECS/GEM communication software.

Using the communication state settings, configure the device assignment, default values of the communication state, etc. to notify the programmable controller CPU about the current communication state.

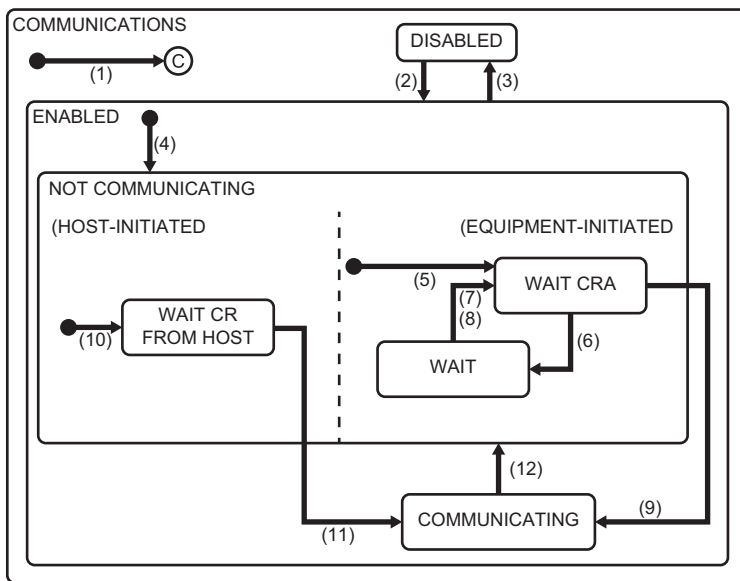

No.	Current state	Trigger	New state	Operation	Comments
(1)	(Enter COMMUNICATIONS state)	System initialization	System default state	Disabled	System default state can be either Communication DISABLED or ENABLED state
(2)	DISABLED (Communication disabled)	Operator switches from communication disabled to enabled	ENABLED (Communication enabled)	Disabled	SECS-II communication is enabled
(3)	ENABLED (Communication enabled)	Operator switches from communication enabled to disabled	DISABLED (Communication disabled)	Disabled	SECS-II communication is disabled
(4)	(Enter to communication ENABLED)	Communication enabled state is activated.	NOT COMMUNICATING (Communication interrupted)	Disabled	Communication enabled state is activated during system initialization, or alternately it can be switched into by operator
(5)	(Enter equipment initiated connect)	(Entered NOTCOMMUNICATING state)	WAIT CRA (Awaiting communication establishment request confirmation)	Communication initialization Communication delay timer is set for timeout S1F13 is sent	Communication establishment is started through equipment initiated connect
(6)	WAIT CRA (Awaiting communication establishment request confirmation)	S1F13 transaction failure ^{*1}	WAIT DELAY (Awaiting delay timer timeout)	Communication delay timer is initialized All messages awaiting transmission are removed from the queue ^{*2}	Timeout is awaited
(7)	WAIT DELAY (Awaiting delay timer timeout)	Communication delay timer is timed out	WAIT CRA (Awaiting communication establishment request confirmation)	S1F13 is sent	S1F14 is awaited (In some cases S1F13 may be received from the host)

No.	Current state	Trigger	New state	Operation	Comments
(8)	WAIT DELAY (Awaiting delay timer timeout)	A message other than S1F13 is received	WAIT CRA (Awaiting communication establishment request confirmation)	Message is discarded (no response) Communication delay timer is set for timeout S1F13 is sent	It means that there is a possibility of communication establishment
(9)	WAIT CRA (Awaiting communication establishment request confirmation)	S1F14 with COMMACK = 0 is received as expected	COMMUNICATING (Communication in progress)	Disabled	Communication shall be established
(10)	(Enter host initiated connect)	(Entered NOTCOMMUNICATING state)	WAIT CR FROM HOST (Awaiting communication establishment)	Disabled	S1F13 is awaited from the host
(11)	WAIT CR FROM HOST (Awaiting communication establishment from the host)	S1F13 is received	COMMUNICATING (Communication in progress)	S1F14 is sent with COMMACK=0	Communication is established.
(12)	COMMUNICATING (Communication in progress)	Communication loss	NOT COMMUNICATING (Communication interrupted)	All messages awaiting transmission are removed from the queue	Messages removed from the queue are spooled if necessary

*1 Communication loss, response timeout, etc.

*2 Messages to be transmitted from the queue are spooled in the order of creation.

Communication state model setting

Configure the details of the communication state model.

Default

Window

[GEMFunction] ⇒ [Communication State] ⇒ [Default] tab

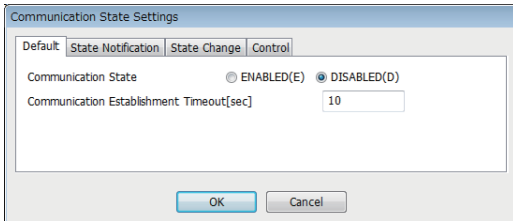

Displayed items

Item	Description
Default communication state	Select the default communication state of the SECS/GEM communication software upon power. This setting is reflected in the equipment variable DefaultCommunicationsState.
Communication establishment timeout	Configure the timeout value for communication delay timer. Values from 1 to 240 seconds can be specified. This setting is reflected in the equipment variable EstablishCommunicationsTimeout.

State notification

Window

[GEMFunction] ⇒ [Communication State] ⇒ [State Notification] tab

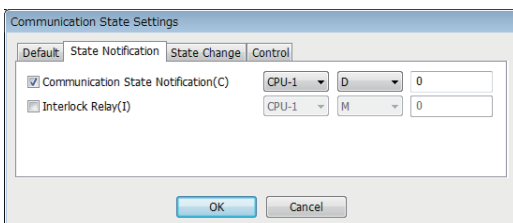

Displayed items

Item	Description
Communication state notification	Set the register used by the SECS/GEM communication software to notify the current state of the communication state model to the Programmable Controller CPU. This setting is reflected in the state variable CommunicationsState. For more details of values, see the following reference. Page 198 Variables defined by default
Interlock relay	To lock transition of the communication state and transition operations, use an interlock relay to switch this relay ON from the programmable controller CPU.

State Change

Window

 [GEMFunction] ⇒ [Communication State] ⇒ [State Change] tab

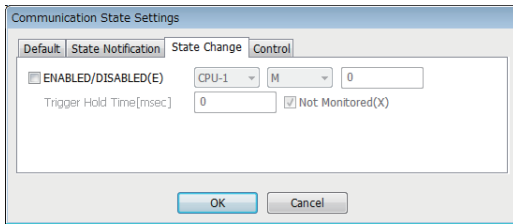

Displayed items

Item		Description
ENABLED/DISABLED	—	This relay enables the Programmable Controller CPU to change the communication state of the SECS/GEM communication software. When this setting is enabled, turn the trigger ON to configure an ENABLED state and turn the trigger OFF to configure a DISABLED state.
	Trigger Hold Time	An ENABLED/DISABLED trigger results when the ENABLED/DISABLED relay was held for the configured time. If the "Not Monitored" checkbox is selected, ENABLED/DISABLED trigger processing is carried out without hold monitoring.

Control

Window

 [GEMFunction] ⇒ [Communication State] ⇒ [Control] tab

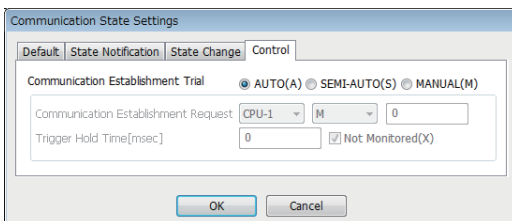

Displayed items

Item		Description
Communication establishment attempt	—	Select whether communication establishment is to be attempted automatically by the SECS/GEM communication software or upon request from the programmable controller CPU. <ul style="list-style-type: none"> AUTO: SECS/GEM communication software attempts to establish communication automatically. SEMI-AUTO: Attempted automatically by the SECS/GEM communication software only when the Communication establishment request relay is ON. MANUAL: Attempts to establish communication upon request from the programmable controller CPU. Determine the value of the communication state notification register by the programmable controller CPU and switch ON the communication establishment relay defined below.
	Communication establishment request	Configure the relay to notify the SECS/GEM communication software about the communication establish attempt when SEMI-AUTO/MANUAL was selected. When this relay is switched ON, the SECS/GEM communication software attempts to establish communication.
	Trigger Hold Time	A communication establishment request trigger results when the communication establishment request relay is held for the configured time. If the "Not Monitored" checkbox is selected, Communication establishment request trigger processing is carried out without hold monitoring.

8.5 CONTROL STATE MODEL MANAGEMENT

Series	SECS/GEM communication software		
	Non-GEM version	GEM version	GEM advanced version
MELSEC-Q series	—	○	○
MELSEC iQ-R series	—	○	○

The following state model is used by the host to manage the state of the 3 control levels (high: remote, medium: local, low: offline) of the equipment.

- Remote: the equipment can be controlled from host
- Local: the host can access the information of the equipment, but operations are limited
- Offline: the equipment cannot be controlled from the host, and access to information is also limited

SECS/GEM communication software manages the control state model completely, such as device assignment for notifying the current control state to the Programmable Controller CPU, assignment of the control transition switch relay and setting of the control state default value.

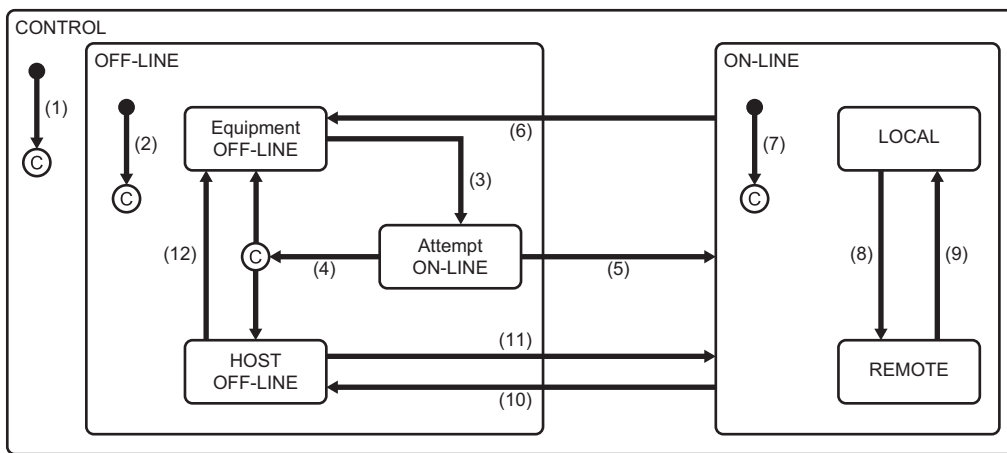

No.	Current state	Trigger	New state	Operation	Comments
(1)	(Enter CONTROL state)	System initialization	System default state	Disabled	System default state is set to online or offline
(2)	(Enter OFF-LINE state)	Enters offline state	OFF-LINE (Offline) Any one of these. • EQUIPMENT OFF-LINE • HOST OFF-LINE • ATTEMPT ON-LINE	Disabled	Equipment enters any of the lower states of the offline state in accordance with default setting
(3)	EQUIPMENT OFF-LINE (Equipment offline)	Operator changes the switch to online	ATTEMPT ON-LINE (Online establishment attempt)	S1F1 is sent.	On entering the ATTEMPT ON-LINE state, S1F1 shall be sent definitely
(4)	ATTEMPT ON-LINE (Online establishment attempt)	Any one of these. • Communication loss • S1F1 reply timeout • Received S1F0	Depends on the setting conditions	Disabled	Depending on the setting, equipment is set to offline or host is set to online.
(5)	ATTEMPT ON-LINE (Online establishment attempt)	Expected S1F2 is received	ON-LINE (Online)	Disabled	No.(7) is entered and transition to online is notified to the host.
(6)	ON-LINE (Online)	Operator changes the switch to offline	EQUIPMENT OFF-LINE (Equipment offline)	Disabled (Event occurrence)	"Equipment offline" event occurs ¹ . In offline state reply to the event is discarded
(7)	(Enter ON-LINE state)	Enters Online state	ON-LINE (Online) The lower state is determined based on remote/local switch setting	Disabled (Event occurrence)	"Control state local" event or "control state remote" event occurs. The actual online lower state to which the transition is done is indicated
(8)	LOCAL (Local)	Operator sets the switch to remote	REMOTE (Remote)	Disabled (Event occurrence)	"Control state remote" event occurs.

No.	Current state	Trigger	New state	Operation	Comments
(9)	REMOTE (Remote)	Operator sets the switch to local	LOCAL (Local)	Disabled (Event occurrence)	"Control state local" event occurs
(10)	ON-LINE (Online)	S1F15 (transition to offline) is received	HOST OFF-LINE (Host offline)	Disabled (Event occurrence)	"Host offline" event occurs
(11)	HOST OFF-LINE (Host offline)	S1F17 (online transition request) is received and accepted	ON-LINE (Online)	Disabled	No.(7) is entered and transition to online is notified to the host.
(12)	HOST OFF-LINE (Host offline)	Operator sets the switch to offline	EQUIPMENT OFF-LINE (Equipment offline)	Disabled (Event occurrence)	"Equipment offline" event occurs.

*1 When there is a transaction started by the host, the SECS/GEM communication software sends an abort message after event message transaction completion.

Control state model setting

Configure the details of the control state model.

Default

Window

[GEMFunction] ⇒ [Control State] ⇒ [Default] tab

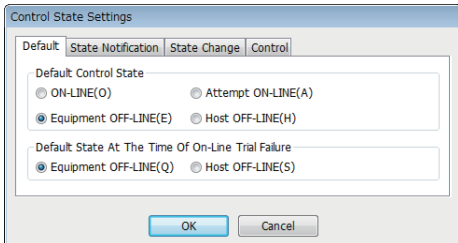

Displayed items

Item	Description
Default control state	Select the control state of the SECS/GEM communication software when the power is turned ON. This cannot be changed from the Programmable Controller CPU. This setting is reflected in the equipment variable DefaultControlState.
Default setting at the time of online attempt failure	Select the default state when online transition fails. This cannot be changed from the Programmable Controller CPU. This setting is reflected in the equipment variable DefaultOfflineState.

State notification

Window

[GEMFunction] ⇒ [Control State] ⇒ [State Notification] tab

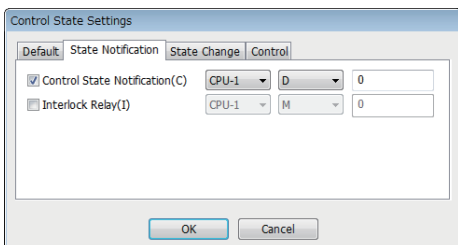

Displayed items

Item	Description
Control state notification	Set the register used by the SECS/GEM communication software to notify the current state of the control state model to the Programmable Controller CPU. This value is the state variable ControlState. For more details of values, see the following reference. Page 198 Variables defined by default
Interlock relay	To lock transition of the control state, use an interlock relay to switch this relay ON from the programmable controller CPU.

State Change

Window

[GEMFunction] ⇒ [Control State] ⇒ [State Change] tab

Control State Settings

Default | State Notification | State Change | Control

ON-LINE/OFF-LINE(O) CPU-1 M 0
Trigger Hold Time[msec] 0 Not Monitored(X)

REMOTE/LOCAL(R) CPU-1 M 0
Trigger Hold Time[msec] 0 Not Monitored(Y)

OK Cancel

Displayed items

Item		Description
ON-LINE/OFF-LINE	—	Set the relay used to notify the SECS/GEM communication software about the transition to ON-LINE/OFF-LINE from the Programmable Controller CPU. When this setting is enabled, turn the trigger ON to configure an ON-LINE state and turn the trigger OFF to configure an OFF-LINE state.
	Trigger Hold Time	An ON-LINE/OFF-LINE trigger results when the ON-LINE/OFF-LINE relay is held for the configured time. If the "Not Monitored" checkbox is selected, ON-LINE/OFF-LINE trigger processing is carried out without hold monitoring.
REMOTE/LOCAL	—	Configure the relay to notify the SECS/GEM communication software from the programmable controller CPU of a REMOTE/LOCAL switch. When this setting is enabled, turn the trigger ON to configure a REMOTE state and turn the trigger OFF to configure a LOCAL state.
	Trigger Hold Time	A REMOTE/LOCAL trigger results when the REMOTE/LOCAL relay is held for the configured time. If the "Not Monitored" checkbox is selected, REMOTE/LOCAL trigger processing is carried out without hold monitoring.

8

Control

Window

[GEMFunction] ⇒ [Control State] ⇒ [Control] tab

Control State Settings

Default | State Notification | State Change | Control

On-Line Establishment Trial AUTO(A) MANUAL(M)

On-Line Request CPU-1 M 0
Trigger Hold Time[msec] 0 Not Monitored(X)

OK Cancel

Displayed items

Item		Description
Attempt ON-LINE	—	Select whether online establishment is to be attempted automatically by the SECS/GEM communication software or upon request from the programmable controller CPU. <ul style="list-style-type: none"> • AUTO: SECS/GEM communication software attempts to establish an online state automatically. • MANUAL: Attempts to establish an online state upon request from the programmable controller CPU. Determine the value of the control state notification register by the programmable controller CPU and switch ON the online request relay defined below.
	Online request	Configure the relay to notify the SECS/GEM communication software about the online establishment attempt when MANUAL was selected for "On-Line Establishment Trial". When this relay is switched ON, the SECS/GEM communication software attempts to establish an online state.
	Trigger Hold Time	An online request trigger results when the On-Line Request relay is held for the configured time. If the "Not Monitored" checkbox is selected, online request trigger processing is carried out without hold monitoring.

8.6 PROCESSING STATE MODEL MANAGEMENT

Series	SECS/GEM communication software		
	Non-GEM version	GEM version	GEM advanced version
MELSEC-Q series	—	○	○
MELSEC iQ-R series	—	○	○

The processing state of the equipment is managed with the following model. When the equipment enters a PROCESS state, it indicates that the process is ready or executing. When it enters an EXECUTING state, it means that the process is running. The programmable controller CPU must manage the processing state model.

Register assign or assign setting of state transition switch relay are implemented in SECS/GEM communication software to enable reception of a notification from the Programmable Controller CPU regarding the current processing state.

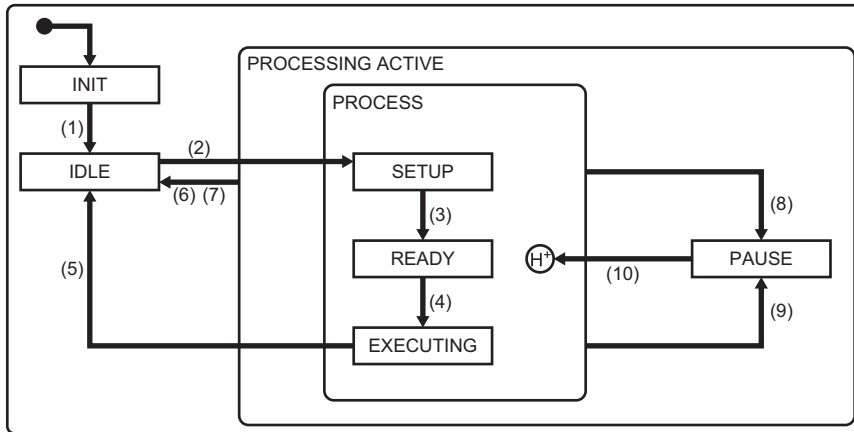

No.	Current state	Trigger	New state	Operation	Comments
(1)	INIT	System initialization	IDLE	Disabled	—
(2)	IDLE	Setup command is issued	SETUP	Disabled	—
(3)	SETUP	Setup is completed and preparation for reception of start instruction is also completed	READY	Depends on the equipment	—
(4)	READY	Start instruction (START) is received from the host or console	EXECUTING	Depends on the equipment	—
(5)	EXECUTING	Processing operation is completed	IDLE	Disabled	—
(6)	PROCESSING ACTIVE	Stop instruction (STOP) is received from the host or console	IDLE	Disabled	—
(7)	PROCESSING ACTIVE	Abort instruction (ABORT) is received from the host or console	IDLE	Depends on the equipment	—
(8)	PROCESS	Decided to pause the process due to alarm occurrence, etc.	PAUSE	Depends on the equipment	The decision about this transition is normally needs support from the operator
(9)	PROCESS	Pause instruction (PAUSE) is received from the host or console	PAUSE	Depends on the equipment	—
(10)	PAUSE	Resume instruction (RESUME) is received from the host or console.	PROCESS Previous state within the PROCESS	Depends on the equipment	Lower state is the previous state before transition to PAUSE

Process state model setting

Configure the details of the processing state model.

Default

Window

[GEMFunction] ⇒ [Processing State] ⇒ [Default] tab

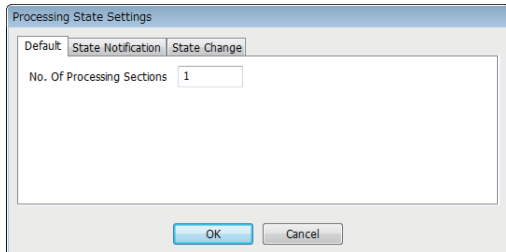

Displayed items

Item	Description
No. of processing units	Set the number of the processing units in the equipment. Up to 99 units can be set. This setting is reflected in the equipment variable ProcessPartsCount. 📖 Page 198 Variables defined by default

State notification

Window

[GEMFunction] ⇒ [Processing State] ⇒ [State Notification] tab

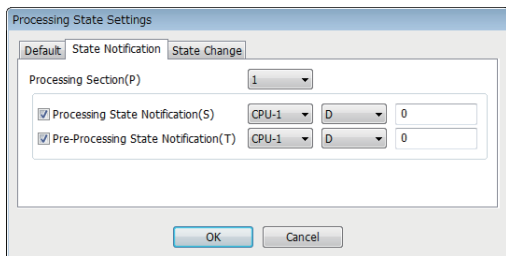

Displayed items

Item	Description
Processing Section	— Select the processing section to configure the register for state notification.
Processing state notification	Configure the register to notify the programmable controller CPU of the current processing state. This setting is reflected in the state variable ProcessState_part01. For more details of values, see the following reference. 📖 Page 198 Variables defined by default
Pre-Processing State Notification	Configure the register to notify the programmable controller CPU of the processing state before transition. This setting is reflected in the state variable PreviousProcessState_part01. For more details of values, see the following reference. 📖 Page 198 Variables defined by default

State Change

Window

[GEMFunction] ⇒ [Processing State] ⇒ [State Change] tab

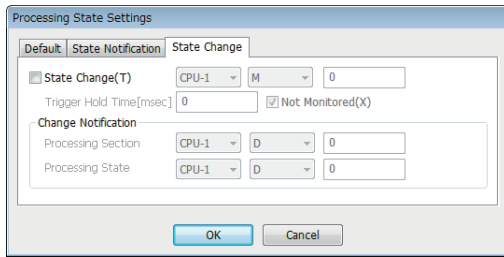

Displayed items

Item		Description
State change trigger	—	Set the replay used by the Programmable Controller CPU to notify SECS/GEM communication software about the transition of the processing state. The processor and processing state changes are reported when the trigger was detected.
	Processing Section	Configure the register to notify the SECS/GEM communication software from the programmable controller CPU of a processor number that changed its processing state. This setting is reflected in the discrete variable ProcessChangePart. For more details of values, see the following reference. Page 198 Variables defined by default
	Processing State	Configure the register to notify the SECS/GEM communication software from the programmable controller CPU of a processing state number that changed its processing state. This setting is reflected in the discrete variable ProcessChangeStatus.

■ Processing state numbers

For the processing state number to be stored to the processing state register, see the following reference.

No.*1	State/Command	Notes
1	IDLE	State variable ProcessState_part01
2	SETUP	State variable ProcessState_part01
3	READY	State variable ProcessState_part01
4	EXECUTING	State variable ProcessState_part01
5	PAUSE	State variable ProcessState_part01
32	SETUP	Setup command IDLE→SETUP
33	READY	Setup completed SETUP→READY
34	START	Start instruction READY→EXECUTING
35	COMPLETE	Processing completed EXECUTING→IDLE
36	STOP	Stop instruction Switch to IDLE
37	ABORT	Abort instruction Switch to IDLE
38	PAUSE	Pause instruction PROCESS→PAUSE
39	RESUME	Resume instruction PAUSE→PROCESS previous state

*1 From 6 through 31, specify any state as a user defined range.

8.7 Alarm Definition (GEM / GEM advanced version)

Alarm notification definitions allow arbitrary definition and sending of the content of the alarm notification used by S5F1. This is completed just by controlling the alarm occurrence/recovery trigger and the register that corresponds to the prescribed alarm at the programmable controller CPU.

For operations during alarm notifications, see the following reference.

 Page 100 Operations during Alarm Notification

Alarm List

Series	SECS/GEM communication software		
	Non-GEM version	GEM version	GEM advanced version
MELSEC-Q series	—	○	○
MELSEC iQ-R series	—	○	○

Displays a list of defined alarms.

Up to 4096 alarms can be defined.

Window

 [GEM Function]⇒[Alarm]

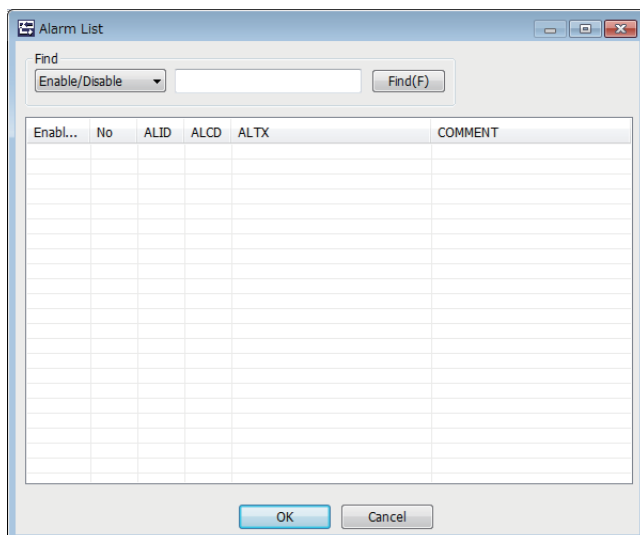

Operations of the Alarm List

The following section explains the operations of the "Alarm List" screen.

Operation	Description
Right-click⇒Shortcut menu[Modify]	Display the "Alarm Definition" screen to modify the content of the selected alarm.
Right-click⇒Shortcut menu[Insert]	Add a new alarm.
Right-click⇒Shortcut menu[Duplicate]	Copy the selected alarm, and then copy the copied alarm to the row below.
Right-click⇒Shortcut menu[Move Up]	Move the selected alarm.
Right-click⇒Shortcut menu[Move Down]	
Right-click⇒Shortcut menu[Delete]	Delete the selected alarm.

Point 

The content of the alarm list is saved to the following file.

(Project save destination)\GEMALM.CSV

When the alarm content is large or redundant, it is convenient to use Microsoft Excel or another external editor to modify this file.

After the corresponding file is edited, the content is updated by opening the same project again.

Alarm Definition

Series	SECS/GEM communication software		
	Non-GEM version	GEM version	GEM advanced version
MELSEC-Q series	—	○	○
MELSEC iQ-R series	—	○	○

Edit the alarm definition.

Window

Select an alarm in the "Alarm list" screen, right-click ⇒ Shortcut menu [Edit]

Displayed items

Item	Description	
Enable Alarm	Select this checkbox to use alarms. The alarm enabled status may be switched by instruction from the host.	
Alarm No.	Configure the number that corresponds to the prescribed alarm state register. (Start from 1)	
ALID	Configure the content of the alarm ID <ALID > related to the alarm number.	
ALCD	Configure the content of the alarm code <ALCD > related to the alarm number.	
Hexadecimal	Select this checkbox to configure ALCD in hexadecimal. If this checkbox is cleared, the notation is decimal.	
ALTX	Configure the content of the alarm text <ALTX > related to the alarm number.	
Comment	Configure the alarm comment. The content of the comment is not sent as an alarm message.	
Link Event	Alarm Occurrence	Select an event report to send when an alarm has occurred.
	Alarm Cancel	Select whether to send an event report when an alarm was cancelled.

Common Alarm Settings

Series	SECS/GEM communication software		
	Non-GEM version	GEM version	GEM advanced version
MELSEC-Q series	—	○	○
MELSEC iQ-R series	—	○	○

Configure the common settings to control the content configured by the Alarm list.

Common

Window

 [GEM Function]⇒[Common Alarm]⇒[Common] tab

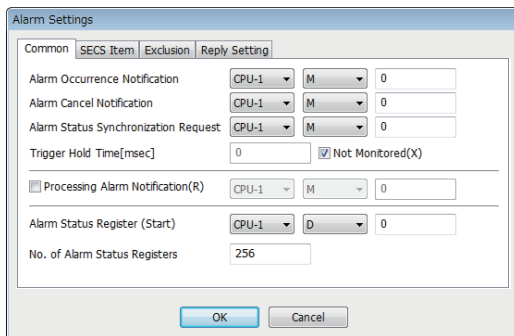

Displayed items

Item	Description
Alarm Occurrence Notification	Configure the trigger relay to notify the SECS/GEM communication software of an alarm occurrence.
Alarm Cancel Notification	Configure the trigger relay to notify the SECS/GEM communication software of an alarm reset.
Alarm Status Synchronization Request	Configure the trigger relay to match the alarm status managed by the programmable controller CPU internally and the alarm status managed by SECS/GEM communication software internally. Upon receiving this trigger request, the alarm state managed by the SECS/GEM communication software is revised to the contents of the prescribed state register.
Trigger Hold Time	A trigger results when the relays configured for Alarm Cancel Notification and Alarm Status Synchronization Request were held just for the configured time. If the "Not Monitored" checkbox is selected, trigger processing is carried out without hold monitoring.
Alarm Processing Notification	Configure the relay to report that alarm sending is being processed. Switches OFF when a secondary message of the final alarm message was received. It is possible to check that the ladder program is performing sending processing when a large number of alarms occur at once.
Alarm Status Register (Start)	Configure the register to display the alarm status. This setting is reflected in the state variable AlarmsSet. For more details of values, see the following reference.  Page 198 Variables defined by default
No. of Alarm Status Registers	One register can manage the alarm status of 16 items. Configure the quantity of registers to be used according to the number of alarm items. Up to 256 registers can be registered (maximum alarm count is 4,096).

SECS Item

Window

[GEM Function] ⇒ [Common Alarm] ⇒ [SECS Item] tab

Displayed items

Item	Description
Item	— Configure the data type and data count of items used by the message.
Data Type	Select the data type of the item.
Data Count	Configure the data count of the item.
Variable Length	Select this checkbox to configure the data count to a variable length.

Exclusion

Window

[GEM Function] ⇒ [Common Alarm] ⇒ [Exclusion] tab

Displayed items

Item	Description
Scenario	— Select the transaction in the GEM alarm scenario.
Enable	Select this checkbox to enable automated response of the selected transaction.
Processing Notification	Configure the relay for the SECS/GEM communication software to notify the programmable controller CPU that the selected scenario is being executed.
Data Lock	Configure the relay to deny the above-mentioned transaction request because of equipment processing, errors, etc. When this relay is ON, secondary messages are not returned when a message related to the selected transaction is received from the host.
ABORT	When the "ABORT" checkbox is selected, an S5F0 secondary message is sent.

Reply Setting

Window

[GEM Function] ⇒ [Common Alarm] ⇒ [Reply Setting] tab

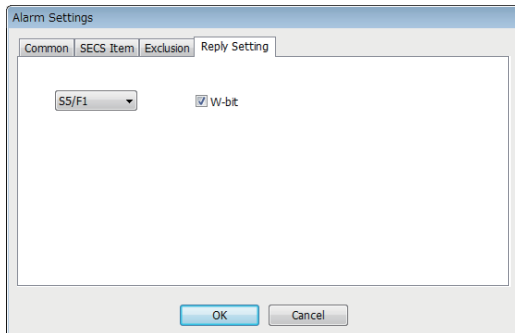

Displayed items

Item	Description
W-bit	Select this checkbox to send an S5F1 message with a W-bit. If this checkbox is cleared, the Alarm Processing Notification relay cannot be used because its original function is no longer satisfied.

Precautions

■ Alarm report sending (S5F1/F2)

Alarm report sending (S5F1/F2) is a reserved transaction, so transaction settings are not necessary.

For details on reserved transactions, see the following reference.

☞ Page 268 List of reserved transactions and format

■ No. of Alarm Status Registers

When multiple registers are used, the consecutive registers from the specified start alarm status register up to the configured quantity targeted.

Make sure not to overlap with any register defined in other item settings.

■ Editing of GEMALM.CSV

GEMALM.CSV is a text file with items delimited by commas. When editing the data, take care not to change the file format.

Furthermore, back up and store the file before modifying it.

■ When reporting multiple alarms simultaneously

If there are too many alarms to be reported simultaneously, some notifications to the host may be missed.

As a guideline, set up to 32 alarms to perform sending requests at one time.

8.8 Spool Function (GEM / GEM advanced version)

Messages that failed to be sent for some reason can be kept as spool messages. Spooled messages can be resent when communication is recovered.

Spooled messages are stored on the memory card.

For the spooling operation, see the following reference.

☞ Page 109 Spooling Operation Sequence

For the operation during spool message sending, see the following reference.

☞ Page 110 Operation sequence during spool message sending

Spool list

Series	SECS/GEM communication software		
	Non-GEM version	GEM version	GEM advanced version
MELSEC-Q series	—	○	○
MELSEC iQ-R series	—	○	○

Shows a list of messages subject to spooling.

Window

☞ [GEM Function]⇒[Spool]

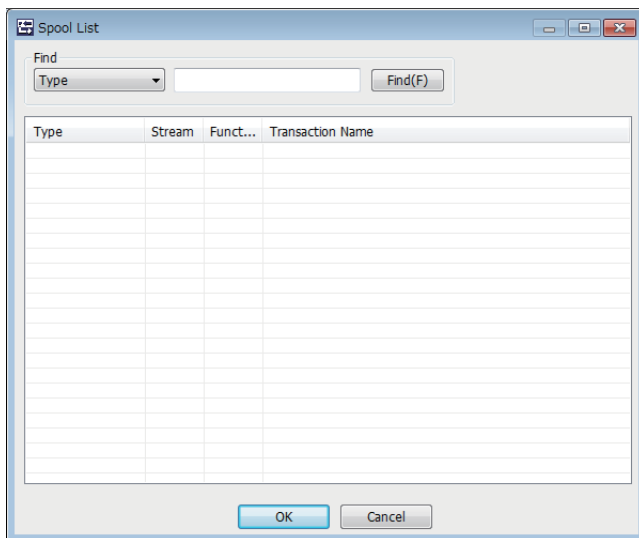

Operations of the Spool List

Operation	Description
Right-click⇒Shortcut menu[Modify]	Display the "Spool Definition" screen to modify the content of the selected spool.
Right-click⇒Shortcut menu[Insert]	Add a new spool.
Right-click⇒Shortcut menu[Move Up]	Move the selected spool.
Right-click⇒Shortcut menu[Move Down]	
Right-click⇒Shortcut menu[Delete]	Delete the selected spool.

Spool Definition

Series	SECS/GEM communication software		
	Non-GEM version	GEM version	GEM advanced version
MELSEC-Q series	—	<input type="radio"/>	<input type="radio"/>
MELSEC iQ-R series	—	<input type="radio"/>	<input type="radio"/>

Edit the spool definition.

Window

 Select a message in the "Spool list" screen, right-click ⇒ Shortcut menu [Edit]

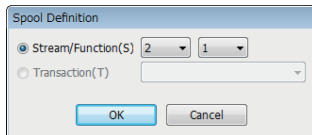

Displayed items

Item	Description
Stream/Function	Select when setting spool targets by Stream/Function.
Transaction	Select when setting a defined transaction to be subject to spooling.

Common Spool Definition settings

Series	SECS/GEM communication software		
	Non-GEM version	GEM version	GEM advanced version
MELSEC-Q series	—	○	○
MELSEC iQ-R series	—	○	○

Common

Window

 [GEM Function]⇒[Common Spool]⇒[Common]

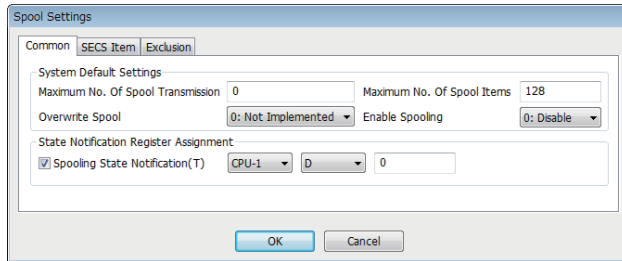

Displayed items

Item		Description
System Default Settings	Maximum No. of Spool Transmission	Specify the maximum number of spool data items to be sent at once from the equipment for an S6F23 (spooled data request) from the host. To have no limit on the maximum number, set 0. The maximum number is reflected in the equipment variable MaxSpoolTransmit and can be changed by an S2F15 (new equipment variable change) from the host.
	Maximum no. of spool items	Configure the maximum number of messages to be spooled at the equipment. This setting is reflected in the equipment variable MaxSpoolCount.
	Overwrite Spool	Select the operation method when the maximum number of spool items is exceeded. • "0: Not performed": discard the overflow. • "1: Perform": overwrite spooled messages. This setting is reflected in the equipment variable OverWriteSpool.
	Enable Spooling	Configure whether to use the spooling function. This setting is reflected in the equipment variable EnableSpooling.
State Notification Register Assignment	Spooling State Notification	This register enables the SECS/GEM communication software to notify the programmable controller CPU of spooling state. This setting is reflected in the state variable SpoolingState. For more details of values, see the following reference.  Page 198 Variables defined by default

SECS Item

Window

[GEM Function]⇒[Common Alarm]⇒[SECS Item]

Displayed items

Item	Description
Item	—
Data Type	Select the data type of the item.
Data Count	Configure the data count of the item.
Variable Length	Select this checkbox to configure the data count to a variable length.

Exclusion

Window

[GEM Function]⇒[Common Spool]⇒[Exclusion]

Displayed items

Item	Description
Scenario	—
Enable	Select the transaction in the GEM spool scenario. The following transactions can be selected. • S2F43: Reset Spooling Streams and Functions • S6F23: Spooled data request
Processing Notification	Select this checkbox to enable automated response of the selected transaction.
Data Lock	Configure the relay for the SECS/GEM communication software to notify the programmable controller CPU that the selected transaction is being executed.
ABORT	Configure the relay to deny the above-mentioned transaction request because of equipment processing, errors, etc. When this relay is ON, secondary messages are not returned when a message related to the selected transaction is received from the host.
	When the "ABORT" checkbox is selected, an SxF0 secondary message is sent.

Important points about spooling

- If spool transmission and trace and fixed cycle sending messages are implemented at the same time, performance may drop. It is recommended that trace / fixed-cycle sending messages are stopped during spool transmission.
- Spool data is saved as files on a memory card so the data is retained even after a power reset. However, if the power is cut suddenly during spooling, the spool files may be corrupted. If the files are corrupted, spooling does not function normally. Please restart the system after deleting the SPOOL.IDX file under the root folder of the memory card. In this case, spool data cannot be recovered.
- If the "overwrite spool" is not implemented, the maximum number of spool items may be lower than the specified spool maximum due to the size of messages to be spooled. When "overwrite spool" is implemented, operations are implemented with the minimum guaranteed number of items.
- The SECS/GEM communication software does not turn OFF the sending request relay if message sending is not complete. Accordingly, describe the handshake response monitoring timer processing of the SECS/GEM communication software at the programmable controller CPU, and switch OFF the sending request trigger relay during a timeout. When the message is subject to spooling at this time, the value of the spooling state notification (SpoolingState) is active.
- While the spooling state notification (SpoolingState) is active, the SECS/GEM communication software does not send a message when the equipment attempts to send a primary message not subject to spooling. However, S1 and S9 related messages are sent.

8.9 PROCESS PROGRAM

Series	SECS/GEM communication software		
	Non-GEM version	GEM version	GEM advanced version
MELSEC-Q series	—	—	○
MELSEC iQ-R series	—	—	○

The following actions are possible: an automatic return of S7F20 (current EPPD data) for an S7F19 (current EPPD request) from the host, deletion of a process program set by an S7F17 (process program deletion command) from the host, and automatic return of S7F18 (confirmation of deletion of process program).

If the process program was changed at the equipment, the host is notified of the change information of the process program by an S6F11 (event report sending).

This function supports the scenario that use S7F23 (Formatted Process Program Send).

In order to use an S7F3 (process program sending), define the transaction and use with the method for device association.

For usage method of process programs, see the following reference.

Page 248 Using the process program

Process Program Settings

Configure the details of the process program.

[GEMFunction] ⇒ [Process Program]

Directory

Sets the directory information and no. of directory entries that can be registered for the process program.

Window

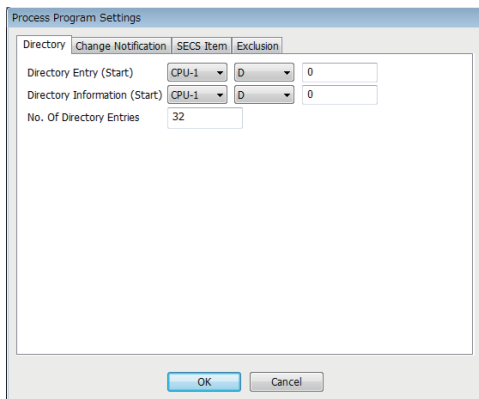

Displayed items

Item	Description
Directory Entry (Start)	Configure the start of the register to store the entry information of the process program directory. For more details of entry information, see the following reference. Page 186 Directory entry information of process program
Directory Information (Start)	Configure the start of the register to store the directory information. For more details of directory information, see the following reference. Page 186 Directory information of process program
No. Of Directory Entries	Configure the number of directory entries. Up to 1024 directory entries can be configured.

■Directory entry information of process program

Name	Required no. of devices	Description
USE flag	1	0 (disabled)/1 (enabled)
DevNo	1	Device no. of the EPPD to be associated

■Directory information of process program

Name	Required no. of devices	Description
PPID	41	Process program ID
ChangeStatus	1	0 (no state change)/1 (create)/2 (edit)/ 3 (delete)
Host delete instruction	1	0 (not specified)/1 (specified)
Selection state	1	0 (not selected)/1 (selected)
DSNAME	17	Data set name
UDStatus	1	0 (none)/1 (upload)/2 (download)
RECLEN	1	Discrete Maximum record length
RTYPE	1	0 (stream)/1 (discrete)
ACK	1	ACK value during upload/download

Change notification

Configure the trigger information to report that a process program was changed or selected from the programmable controller CPU to the SECS/GEM communication software.

To use the process program deletion function, select the [Enable S7F17 Scenario] checkbox, and then define the information of the device to detect notification of deletion, deletion completion, etc. by the programmable controller CPU.

Window

Displayed items

Item	Description
Process Program Change	Configure the trigger to report that the process program was changed at the equipment to the SECS/GEM communication software.
Process Program Select	Configure the trigger to report that the process program was selected at the equipment to the SECS/GEM communication software.
Directory State Synchronization Request	Configure the trigger to request directory state synchronization to the SECS/GEM communication software.
Trigger Hold Time	A trigger results when the relays configured for Process Program Change, Process Program Select, and Directory State Synchronization Request were held just for the configured time. If the "Not Monitored" checkbox is selected, trigger processing is carried out without hold monitoring.

Item		Description
Enable S7F17 Scenario	—	Select this checkbox to enable the S7F17 (Process program deletion instruction).
	Process Program Deletion Notification	Configure the trigger to report that an S7F17 (process program deletion command) was received from the host to the programmable controller CPU.
	Process Program Deletion Completion Notification	Configure the trigger to report that the process program was deleted to the SECS/GEM communication software.
	Trigger Hold Time	A notification trigger results when the relays configured for Process Program Deletion Notification and Process Program Deletion Completion Notification were held just for the configured time. If the "Not Monitored" checkbox is selected, notification trigger processing is carried out without hold monitoring.
	Register to Save Process Program Deletion Results	Configure the register to report that the process program was deleted by a deletion command to the SECS/GEM communication software.

SECS items

Configure the SECS-data item-format related to process programs.

Window

Displayed items

Item	Description
Item	—
Data Type	Select the data type of the item.
Data Count	Configure the data count of the item.
Variable Length	Select this checkbox to configure the data count to a variable length.

Exclusion

Window

Displayed items

Item	Description
Scenario	—
Enable	Select this checkbox to enable automated response of the selected transaction.
Processing Notification	Configure the relay for the SECS/GEM communication software to notify the programmable controller CPU that the selected scenario is being executed.
Data lock	Configure the relay to deny the above-mentioned transaction request because of equipment processing, errors, etc. When this relay is ON, secondary messages are not returned when a message related to the selected transaction is received from the host.
ABORT	If ABORT option is checked, S7F0 secondary message is sent.

8.10 CLOCK

Series	SECS/GEM communication software		
	Non-GEM version	GEM version	GEM advanced version
MELSEC-Q series	—	○	○
MELSEC iQ-R series	—	○	○

Clock function is used to synchronize internal time of the equipment with the host time.

The SECS/GEM communication software registers the time data received by an S2F18 (date and time data) or an S2F31 (date and time set request) from the host to the clock data storage destination register. The time of the equipment can be synchronized with the host by changing the clock data to this time at the programmable controller CPU.

When an S2F17 (date and time request) was received from the host, the clock data of the C Controller module or C intelligent function module is sent to the host by an S2F18 (date and time data) automatically.

- When the equipment requests the time from the host

An S2F17 (date and time request) is sent from the equipment, and the time of the host is configured to the equipment by an S2F18 (date and time data) received from the host.

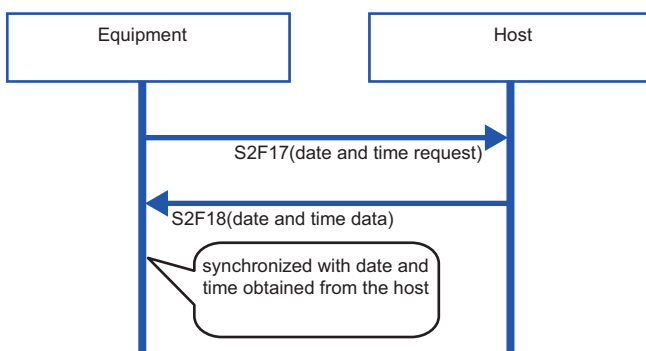

- When the time is designated by the host to the equipment

The time of the host is received by an S2F31 (date and time set request) from the host, and the equipment sends an S2F32 (date and time set Acknowledge).

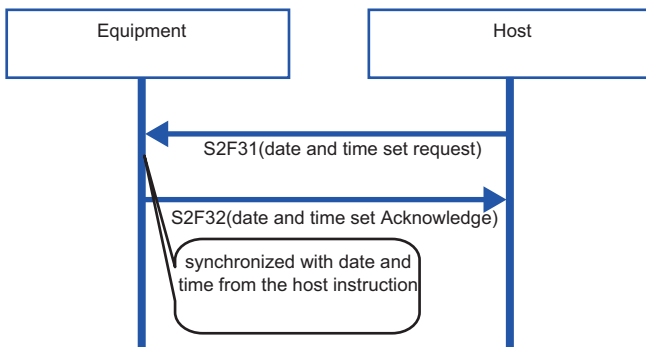

Clock setting

Configure the details of the clock function.

Common

Window

 [GEMFunction] ⇒ [Clock] ⇒ [Common] tab

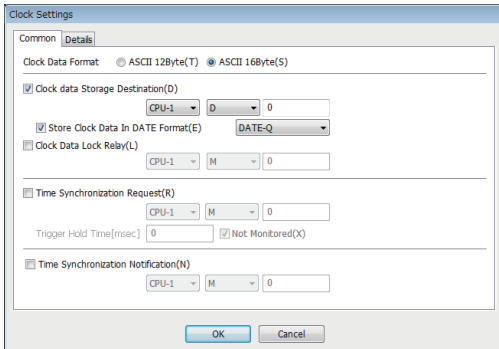

Displayed items

Item	Description
Clock Data Format	Selects whether clock data received in SECS message is of ASCII12Byte or ASCII16Byte. This setting is reflected in the equipment variable TimeFormat.
Clock data storage destination	Configure the register to notify the programmable controller CPU about the received clock data. This setting is linked to the state variable Clock. To convert received ASCII data to numerical data that the programmable controller CPU can process easily, select the "Store Clock Data In DATE Format" checkbox and select either "DATE-A" or "DATE-Q".
Clock Data Lock Relay	To lock the update of clock data, a clock-data lock relay is used, and this relay is turned ON from the Programmable Controller CPU.
Time Synchronization Request	Configure the relay to request sending of an S2F17 (date and time synchronization request) to the SECS/GEM communication software from the programmable controller CPU when there is a time synchronization request from the equipment to the host. It is necessary to select the checkbox in addition to "Request From Device To The Host (S2F17)" of Advanced Settings.
Time Synchronization Notification	Configure the relay for the SECS/GEM communication software to notify the programmable controller CPU of receipt of clock data when the host request time synchronization to the equipment.

Detail

Window

[GEMFunction] ⇒ [Clock] ⇒ [Details] tab

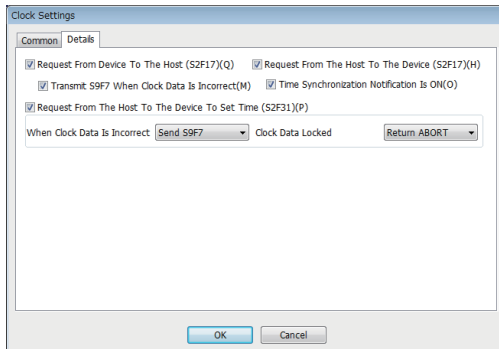

Displayed items

Item		Description
Request from Equipment to Host (S2F17)	—	Select this checkbox to send an S2F17 (date and time synchronization request) from the equipment to the host. It is necessary to also define the Time Synchronization Request relay of the Common settings.
	S9F7 transmission in case of incorrect clock data	Select this checkbox when it is necessary to send a S9F7 (incorrect format) message to the host when the received clock data is of an incorrect format.
Request from the Host to the Equipment (S2F17)	—	Select this checkbox to receive an S2F17 (date and time synchronization request) from the host.
	Time synchronization notification is set	Select this checkbox when a time synchronization notification to the programmable controller CPU is necessary. It is necessary to also define the Time Synchronization Notification relay of the Common settings.
Request from the Host to the equipment to set time (S2F31)	—	Select this checkbox to receive an S2F31 (date and time set request) at equipment from the host. Configure the content of the response message if the received clock data format is incorrect (Return TIACK = 1 / Return ABORT / Send S9F7 / No judgment) and the content of the response message if clock data update is locked (Return TIACK = 1 / Return ABORT).

8.11 VARIABLE SETTING

Series	SECS/GEM communication software		
	Non-GEM version	GEM version	GEM advanced version
MELSEC-Q series	—	○	○
MELSEC iQ-R series	—	○	○

Configure the various state variable data and equipment variables stored in the equipment.

Variable data can be reported as an event report. Furthermore, it is possible to change settings via instructions from the host and report list data.

Variable list

Display the default variable stored in the SECS/GEM communication software, and a list of added user defined variables.

Up to 65,535 variables can be configured.

Window

 [GEMData] ⇨ [Variable]

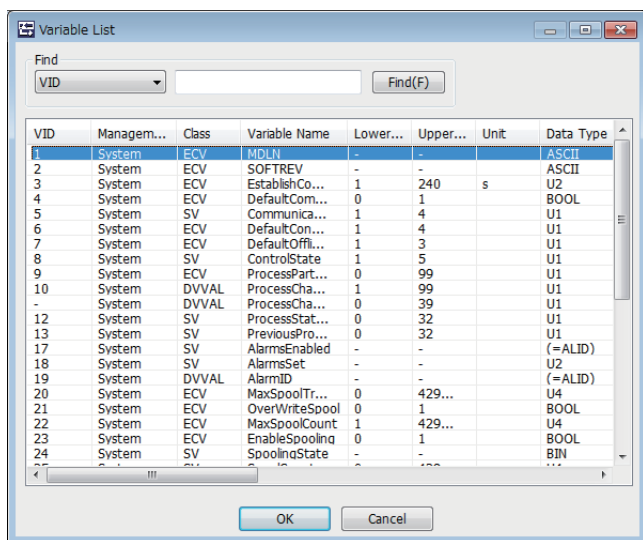

Operations of the Variable List

Operation	Description
Right-click⇨Shortcut menu[Modify]	Display the "Variable Definition" screen to modify the content of the selected variable.
Right-click⇨Shortcut menu[Insert]	Add a new variable.
Right-click⇨Shortcut menu[Duplicate]	Copy the selected variable, and then copy the copied variable to the row below.
Right-click⇨Shortcut menu[Move Up]	Move the selected variable.
Right-click⇨Shortcut menu[Move Down]	
Right-click⇨Shortcut menu[Delete]	Delete the selected variable.

Cache settings variables

If there are many storage registers of registered variables, and these are defined by I/O assignment, configure the cache settings to ensure performance.

Window

 [GEMData] ⇄ [Variable Cache]

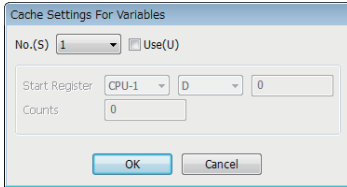

Operating procedure

1. Select the variable cache number to be configured by "Setting".
2. Select the "Use" checkbox.
3. Configure the first register to be used and the number of registers to be used.

Precautions

Up to 32 items for variable cache can be configured.

One cache setting must be up to 4 KB (2048 registers).

However, restrict the range of cache registration to a smaller one, to secure the SECS/GEM communication software operation performance.

Variable definition

Configure the variables.

Basic

Window

Select a variable in the "Variable list" screen, right-click ⇒ Shortcut menu [Edit] ⇒ [Basic] tab

Displayed items

Item	Description	
Class	Configure the variable attribute. <ul style="list-style-type: none"> SV: state variable ECV: Equipment constant DVVAL: Discrete variable MEMBER: variables used as list members 	
Management classification	Displays the management classification. <ul style="list-style-type: none"> System: variable defined in advance by the SECS/GEM communication software. Equipment: newly added variable 	
VID	Configure the variable ID. A unique value is set to VID in all classes except for MEMBER class.	
Variable name	Configure the variable name.	
Comment	Configure a comment for the variable.	
Unit	Select a unit for the value defined in GEM.	
Data type settings	Data type	Configure the data type to be stored in the register. If SECS data stored in the register as a numerical value is to be sent as ASCII, the SECS/GEM communication software can automatically convert the data and send it just by setting the respective data type.
	SECS type	Configure the format code of SECS data based on communication specifications.
	Data count	Configure the data count. The Data Count displayed differs by the configured Data Type. <ul style="list-style-type: none"> BIN: Byte count ASCII/JIS8: Character count (one-byte character) LIST: Number of member variables configured by the list setting Other data types: Fixed to 1
	Variable length	Select this checkbox to configure the data count to a variable length. The Variable Length setting is enabled when the data type is "ASCII" or "LIST". Operation when the variable length was configured is as follows. <ul style="list-style-type: none"> ASCII: the size up to Null stopper of the register is the number of data items. LIST: The number of member variables received from the programmable controller CPU is the number of data items.
	[List Setup] button	Configure the member variables. Available when the data type is "LIST". For more details, see the following reference. ☞ Page 197 List setting

Item		Description
Variable value settings	Variable Type	Select the handling method of the value configured to "Variable Value". <ul style="list-style-type: none"> Fixed value: "Variable Value" is the fixed value of the variable. This setting cannot be changed from the programmable controller CPU or host. Setup value: "Variable Value" is the initial value of the "Storage destination register". Applied as the initial value when "Variable Setup" is "With Setup" of operations at start-up and the "Configuration File Browse" was set to "Tool Configuration File" when updating the SECS/GEM communication software pre-installed model module. (Page 112 Updating the SECS/GEM communication software pre-installed model module) Default value: "Variable Value" is the default value of the "Storage destination register".
	Variable Value	Configure the variable value.
	Storage register	Configure the register to store the value of the variable. Variable Type can be configured to "Setup Value" or "Default Value".

Detail

Window

Select a variable in the Variable list, right-click⇒Shortcut menu [Edit]⇒[Details] tab

8

Displayed items

Item		Description
Has Upper limit value/Lower limit value		If the variable is data that has upper and lower limit values, select the "Upper Limit Value/Lower Limit Value Defined" checkbox, and then configure the values.
Limit attribute setting*1	—	If the variable is subject to limit monitoring, select the "With Limit Monitoring" checkbox. It is necessary to click the [Limit Attribute Definition] button, and then configure the limit settings. For details of limit attribute definitions, see the following reference. Page 202 LIMIT ATTRIBUTE DEFINITION
	No. of limit monitoring	Configure the number of limit attributes to be monitored using this variable.
	Event link	Select the event to be reported to the host when the variable value crosses the region configured by the limit attribute.

*1 Handled by only the GEM advanced version.

Point

Limit attributes can be configured for variables that satisfy all the following conditions.

- At the [Basic] tab, configure [SV] for "Class"
- At the [Basic] tab, configure a numeric type (BOOL, I1, I2, I4, U1, U2, U4, F4, or F8) for "Data Type"
- At the [Details] tab, select the "Upper Limit Value/Lower Limit Value Defined" checkbox

Precautions

If the limit monitoring function is enabled, a sampling operation of the device that is storing the variable value is performed. Pay sufficient attention to performance when using this function.

Changing default variables

- Variables with [System] as the management classification cannot be deleted.
- To disable variables with [System] as the management classification, set a blank for "VID", and configure "Variable Type" to "Fixed Value".
- When changing "VID", variables subject to reports cannot have "VID" changed. Change the setting after either excluding from reports or deleting reports.

☞ Page 206 Default Definition Reports

List setting

When the data type is "LIST", it is possible to add member variables to the list.

It is necessary to predefine the variables to be added in the variable list. Variables that do not have the class of MEMBER can also be added to member variables.

It is possible to link up to 256 member variables with a maximum of 8 levels (hierarchies) for a single list variable.

Window

Select a variable in the "Variable list" screen, right-click ⇒ Shortcut menu [Edit] ⇒ [List Setting] button

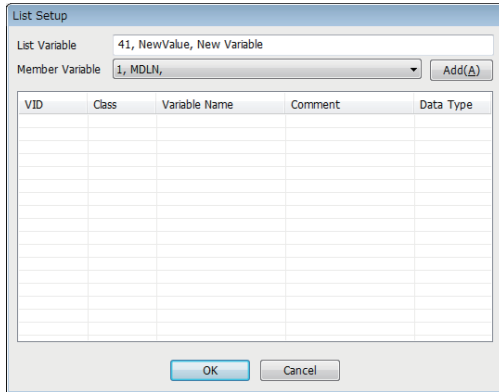

Operations of List Setting

■Add

Add a member variable.

1. Select a member variable to be added by "Member variable".
2. Click the [Add] button.

Point

When a list of variable with two or more levels is configured, return to the "Variable List" screen, select the parent list variable, and then repeat the addition procedure.

■Move Up / Move Down

Move the selected variable.

Right-click ⇒ Shortcut menu [Move Up] / [Move Down]

■Delete

Delete the selected variable.

Right-click ⇒ Shortcut menu [Delete]

Variables defined by default

The following section shows predefined variables of the SECS/GEM communication software. These include variables independently defined by SECS/GEM communication software also.

Name	Classification	Description	Format	E30 standard	Variable value settings	Notes
MDLN	ECV	Module name	ASCII 6Byte	—	Fixed value Can be set	It is defined in system default settings. It is used in S1F13 and S1F2.
SOFTREV	ECV	Software revision	ASCII 6Byte	—	Fixed value Can be set	It is defined in system default settings. It is used in S1F13 and S1F2.
EstablishCommunicationsTimeout	ECV	Attempt Communication establishment attempt timer	U2	○	Can be set	It is defined in communication state model settings. Default value: 10s (1 to 240)
DefaultCommunicationsState	ECV	Default communication state	U1	—	Can be set	It is defined in communication state model settings. 0: DISABLED 1: ENABLED
CommunicationsState	SV	Communication state	U1	—	Register notification Can be set	It is defined in communication state model settings. 1: Communication disabled (DISABLED) 2: Communication interrupted (WAIT CRA/WAIT CR FROM HOST) 3: Communication interrupted (WAIT DELAY/WAIT CR FROM HOST) 4: Communication in progress (COMMUNICATING) Default value: 1
DefaultControlState	ECV	Default control state	U1	—	Fixed value Can be set	It is defined in control state model settings. 1: equipment offline 2: transition to online in progress 3: host offline 4: Online Default value: 1
DefaultOfflineState	ECV	Default state upon online establishment failure	U1	—	Fixed value Can be set	It is defined in control state model settings. 1: equipment offline 3: host offline Default value: 1
ControlState	SV	Control state	U1	○	Register notification Can be set	It is defined in control state model settings. 1: equipment offline 2: transition to online in progress 3: host offline 4: online local 5: online remote Default value: 1
ProcessPartsCount	ECV	No. of processing units	U1	—	Fixed value Can be set	It is defined in processing state model settings. Default value: 1 (0 to 99)
ProcessChangePart	DVVAL	Process state change processing unit number	U1	—	Can be set	It is defined in processing state model settings. Programmable Controller CPU notifies the processing unit number whose state has been changed.

Name	Classification	Description	Format	E30 standard	Variable value settings	Notes
ProcessChangeStatus	DVVAL	Process state change state	U1	—	Register reference Can be set	It is defined in processing state model settings. State number related to the processor with the changed state is reported from the programmable controller CPU 1: IDLE 2: SETUP 3: READY 4: EXECUTING 5: PAUSE 32: Setup command IDLE → SETUP 33: Setup completed SETUP → READY 34: Start instruction READY → EXECUTING 35: Process completed EXECUTING → IDLE 36: Stop instruction, switch to IDLE 37: Abort instruction, switch to IDLE 38: Pause instruction PROCESS → PAUSE 39: Resume instruction PAUSE → Previous PROCESS state
ProcessState_part01	SV	Current process state	U1	○	Register notification Can be set	It is defined in processing state model settings. State number related to the corresponding processor can be configured for notification to a register 1: IDLE 2: SETUP 3: READY 4: EXECUTING 5: PAUSE
PreviousProcessState_part01	SV	State prior to process state change	U1	○	Register notification Can be set	It is defined in processing state model settings. State number related to the corresponding processor can be configured for notification to a register 1: IDLE 2: SETUP 3: READY 4: EXECUTING 5: PAUSE
AlarmsEnabled	SV	Show the list of alarm IDs in the current alarm occurrence state	LIST	○	Cannot be set	It is managed within SECS/GEM communication software. (0 to 4096)
AlarmsSet	SV	Show the list of currently occurring alarm IDs	LIST	○	(Refer to Remarks)	It is defined in alarm definition settings. The occurring state details are defined in the alarm state register.
AlarmID	DVVAL	Occurred/ Cancelled Alarm ID	—	○	—	It is managed within SECS/GEM communication software
MaxSpoolTransmit	ECV	Maximum no. of spool transmission	U4	○	Can be set	It is defined in spool settings. Default value: 1024 (0 to 4294967295, 0 means all is transmitted)
OverWriteSpool	ECV	Operation upon full spool	BOOL	○	Can be set	It is defined in spool settings. 0: do not spool further 1: overwrite from the oldest Default value: 0
MaxSpoolCount	ECV	Maximum no. of spool items	U4	—	Can be set	It is defined in spool settings. Default value: 32767(1 to 4294967295)
EnableSpooling	ECV	Enable spool	BOOL	○	Can be set	It is defined in spool settings. 0: disable spool 1: enable spool Default value: 0

Name	Classification	Description	Format	E30 standard	Variable value settings	Notes
SpoolingState	SV	Spooling state	BIN	—	Register notification Can be set	It is defined in spool settings. 00H: spool stopped 01H: active, no input, empty spool 02H: active, spool transmission, empty spool 03H: active, purge spool, empty spool 81H: active, no output, full spool 82H: active, spool transmission, full spool 83H=active, purge spool, full spool
SpoolCountActual	SV	No. of actual spool messages	U4	○	Cannot be set	It is managed within SECS/GEM communication software (0 to 4294967295).
SPoolCountTotal	SV	No. of cumulative spool messages	U4	○	Cannot be set	It is managed within SECS/GEM communication software (0 to 4294967295).
SpoolFullTime	SV	Spool full time	ASCII	○	Cannot be set	Format: YYYYMMDDhhmmsscc (Compliant with TimeFormat)
SpoolStartTime	SV	Spool start-up time	ASCII	○	Cannot be set	Format: YYYYMMDDhhmmsscc (Compliant with TimeFormat)
Clock	SV	Current time within equipment	ASCII 16/12Byte	○	Can be set	Time data of the SECS/GEM communication software pre-installed model module (Format: YYYYMMDDhhmmsscc)
TimeFormat	ECV	Time data format	U1	○	—	It is defined in clock settings 0: 12 byte format 1: 16 byte format Default value: 16 byte
ChangeECID	DVVAL	Changed Equipment constant ID	—	—	Register reference Can be set	The format is the same as that of Equipment constant ID
HostChangeECID	DVVAL	Equipment constant ID changed by host	—	—	Register notification Can be set	The format is the same as that of Equipment constant ID
LimitsSamplingInterval	ECV	Sampling cycle for limit monitoring	U4	—	Fixed value Can be set	It is defined in limit monitoring settings. Default value: 5000ms (1000 to 4294967295)
EventLimit	DVVAL	Limit/Cross limit ID	—	○	Cannot be set	It is managed within SECS/GEM communication software The format is the same as that of limit ID (list structure in case of multiple occurrence)
LimitVariable	DVVAL	VID that exceeded limit monitoring area	—	○	Cannot be set	It is managed within SECS/GEM communication software The format is the same as that of variable ID
TransitionType	DVVAL	Transition direction of the monitoring scope of the occurred limits	BIN	—	Cannot be set	It is managed within SECS/GEM communication software 0: transition from downward direction to upward direction 1: transition from upward direction to downward direction
EventsEnabled	SV	List of events enabled for report	LIST	○	Cannot be set	It is managed within SECS/GEM communication software.
PPChangeName	DVVAL	Process program name changed by operator	—	○	Cannot be set	It is managed within SECS/GEM communication software The format is the same as that of Process program ID
PPChangeStatus	DVVAL	Process program changed event contents	U1	○	Cannot be set	It is managed within SECS/GEM communication software 1: created 2: edited 3: deleted 4 to 63: held (pending)
PPExecName	SV	Process program ID of the selected Process program	LIST	○	Cannot be set	—

Name	Classification	Description	Format	E30 standard	Variable value settings	Notes
PPDeleteResult	DVVAL	Process program deletion results	BIN	—	Can be set	It is used in S7F18 return
PPEnabled	ECV	Effective process program	—	—	Cannot be set	It is managed within SECS/GEM communication software
EPPD	ECV	Process program directory	LIST	—	—	Process program directory information

8.12 LIMIT ATTRIBUTE DEFINITION

Series	SECS/GEM communication software		
	Non-GEM version	GEM version	GEM advanced version
MELSEC-Q series	—	○	○
MELSEC iQ-R series	—	○	○

If limit attributes are defined, events can be reported to the host when the variable value crosses the region configured by the limit attribute.

Limit attribute list

The list displays the defined limits.

The limit attribute settings of the selected variables are displayed on the "Limit Attribute List" screen.

Up to 16 limits can be configured.

Window

Select a variable in the Variable list, right-click⇒Shortcut menu [Edit]⇒[Limit Attribute] button

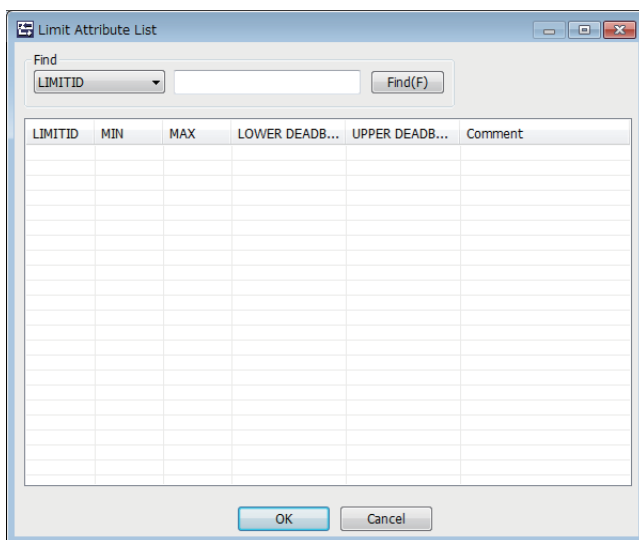

Operations of the Limit Attribute List

Operation	Description
Right-click⇒Shortcut menu[Modify]	Display the "Limit Attribute Definition" screen to modify the content of the selected limit. (Page 203 Limit attribute definition)
Right-click⇒Shortcut menu[Insert]	Add a new limit.
Right-click⇒Shortcut menu[Duplicate]	Copy the selected limit, and then copy the copied limit to the row below.
Right-click⇒Shortcut menu[Move Up]	Move the selected limit.
Right-click⇒Shortcut menu[Move Down]	
Right-click⇒Shortcut menu[Delete]	Delete the selected limit.

Limit attribute definition

Define the limit attribute.

Window

Select the limit attribute at the "Limit Attribute List" screen, right-click⇒Shortcut menu [Edit]

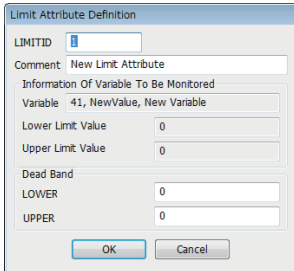

Displayed items

Item	Description
LIMITID	Configure the management number of the limit attribute.
Comment	Configure the comment of the limit attribute.
Information Of Variable To Be Monitored	The variable name, and the upper and lower values are displayed.
Dead band	Configure the upper and lower limit dead-band values for limit monitoring region.

8.13 REPORT SETTING

Series	SECS/GEM communication software		
	Non-GEM version	GEM version	GEM advanced version
MELSEC-Q series	—	○	○
MELSEC iQ-R series	—	○	○

Event report data transmitted from the equipment consists of one or more reports, and a report consists of one or more collections of variables.

Report list

Display the default reports in the SECS/GEM communication software, and a list of added user reports.

Up to 512 reports can be configured.

Window

 [GEMData] ⇨ [Report]

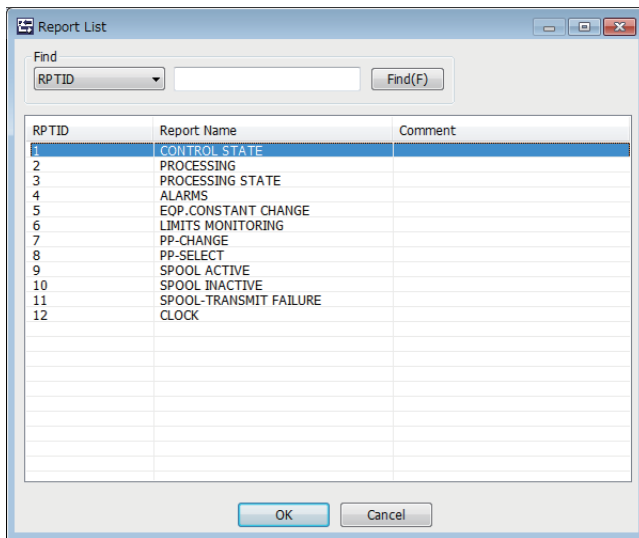

Operations of the Report List

Operation	Description
Right-click⇨Shortcut menu[Modify]	Display the "Report Definition" screen to modify the content of the selected report. (Page 205 Report definition)
Right-click⇨Shortcut menu[Insert]	Add a new report.
Right-click⇨Shortcut menu[Duplicate]	Copy the selected report, and then copy the copied report to the row below.
Right-click⇨Shortcut menu[Move Up]	Move the selected report.
Right-click⇨Shortcut menu[Move Down]	
Right-click⇨Shortcut menu[Delete]	Delete the selected report.

Report definition

Define the report.

Window

Select a report at the "Report List" screen, right-click⇒Shortcut menu [Edit]

Displayed items

Item	Description
RPTID	Configure the report ID.
Report Name	Configure the report name.
Comment	Configure the comment.
[Create Report] button	Display the "Create Report" screen. For details, see the following reference. Page 205 Create Report

Create Report

Configure the report content.

Up to 256 variables can be configured for one report.

Window

Click the [Create Report] button at the "Report Definition" screen.
Or [GEM Data]⇒[Create Report]

Operations of Create Report

■Add

Add a variable.

1. Select the report to be edited from "Report".

When the [Create Report] button was clicked on the "Report Definition" screen, and the "Create Report" screen was opened, the report is fixed to report selected at the "Report Definition" screen.

2. Select the variable to be added to the report by using "Variable".
3. Click the [Add] button.

■Move Up / Move Down

Move the selected variable.

 Right-click⇒Shortcut menu[Move Up]/[Move Down]

■Delete

Delete the selected variable.

 Right-click⇒Shortcut menu[Delete]

Default Definition Reports

The following table shows reports that are predefined in the SECS/GEM communication software.

Report name	Used variable	Remarks, related events
CONTROL STATE	ControlState, Clock	Control state transition event
PROCESSING	Clock, PreviousProcessState_part01	Process start, completion and stop event
PROCESSING STATE	Clock, ProcessState_part01, PreviousProcessState_part01	Equipment process state transition event
ALARMS	Clock, AlarmID, AlarmSet	Basic format of report linked to alarm
EQP.CONSTANT CHANGE	ChangeECID	Equipment constant change event
LIMITS MONITORING	Clock, LimitVariable, EventLimit, TransitionType	Event of transition within the Limit area
PP-CHANGE	PPChangeName, PPChangeStatus	Process program change event
PP-SELECT	PPExecName	Process program selection event
SPOOL ACTIVE	SpoolStartTime	Spooling start-up event
SPOOL INACTIVE	SpoolCountTotal	Spooling stop event
SPOOL-TRANSMIT FAILURE	Clock, SpoolCountActual, SpoolCountTotal	Spool transmission failure event
CLOCK	Clock	Material transfer, terminal service event, etc.

8.14 EVENT SETTING

Series	SECS/GEM communication software		
	Non-GEM version	GEM version	GEM advanced version
MELSEC-Q series	—	○	○
MELSEC iQ-R series	—	○	○

Events are created by combining the timing of the event occurrence and the defined report.

The event timing can be configured as the time of occurrence of an event recognized by the SECS/GEM communication software, such as online confirmation or an alarm occurrence, or an arbitrary timing from the programmable controller CPU.

Event list

Display the default variable events stored in the SECS/GEM communication software, and a list of added user defined events. Up to 512 events can be configured.

Window

 [GEMData] ⇨ [Event]

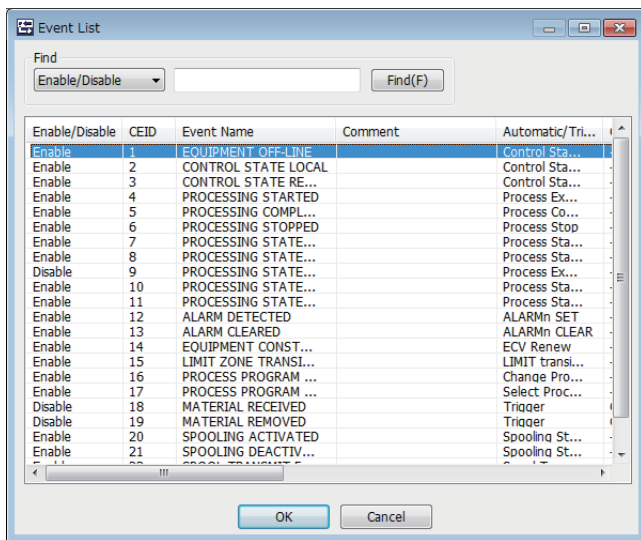

Operations of the Event List

Operation	Description
Right-click⇨Shortcut menu[Modify]	Display the "Event Definition" screen to modify the content of the selected event. ( Page 208 Event definition)
Right-click⇨Shortcut menu[Insert]	Add a new event.
Right-click⇨Shortcut menu[Duplicate]	Copy the selected event, and then copy the copied event to the row below.
Right-click⇨Shortcut menu[Move Up]	Move the selected event.
Right-click⇨Shortcut menu[Move Down]	
Right-click⇨Shortcut menu[Delete]	Delete the selected event.

Event definition

Define the event.

Window

Select an event at the "Event List" screen, right-click⇒Shortcut menu [Edit]

Displayed items

Item	Description
Enable event	Select this checkbox to enable the event.
CEID	Configure the event ID based on communication specifications.
Event name	Configure the event name based on communication specifications.
Comment	Configure the comment.
Automatic event transmission	Select this setting to set the timing of the occurrence of the event as the control event occurrence time of the SECS/ GEM communication software. The control event of the SECS/GEM communication software must be configured.
Sequencer Transmission Request	Select to set the timing of the event occurrence as the detection time of the trigger from the programmable controller CPU. The sending request trigger relay, handshake specification, and trigger hold time must be configured.
Response monitoring	Select this checkbox to perform response monitoring of S6F11 (event report sending) to be sent. When this option is checked, W bit (response request) is added to the message to be transmitted.
Response monitoring	Select this checkbox to detect whether the secondary message was received normally. If the handshake unit of "Sequencer Transmission Request" is configured to "Handshake (for each message)", configure a relay that is different from the sending request trigger.
[Create Event] button	Display the "Create Event" screen. For details, see the following reference. ☞ Page 209 Create Event

Create Event

Configure the report to be sent by the event.
Up to 64 reports can be configured for one event.

Window

 Click the [Create Event] button at the "Event Definition" screen.
Or [GEM Data]⇒[Create Event]

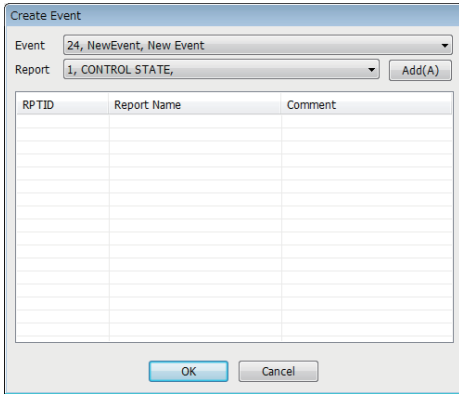

RPTID	Report Name	Comment

Operations of Create Event

■Add

Add a report.

1. Select the event to be configured the report by using "Event".
When the [Create Event] button was clicked on the "Event Definition" screen, and the "Create Event" screen was opened, the event is fixed to the selected event of the "Event Definition" screen.
2. Select the report to be configured to the event by using "Report".
3. Click the [Add] button.

■Move Up / Move Down

Move the selected variable.

 Right-click⇒Shortcut menu[Move Up]/[Move Down]

■Delete

Delete the selected variable.

 Right-click⇒Shortcut menu[Delete]

Events defined by default

The following table shows events that are predefined in the SECS/GEM communication software.

Event name	Trigger	Link report and remarks
EQUIPMENT OFF-LINE	Automatic (ON-LINE->OFF-LINE)	Control state report
CONTROL STATE LOCAL	Automatic (OFF-LINE->ON-LINE, REMOTE->LOCAL)	Control state report
CONTROL STATE REMOTE	Automatic (OFF-LINE->ON-LINE, LOCAL->REMOTE)	Control state report
PROCESSING STARTED	Automatic (->EXECUTING)	Process report
PROCESSING COMPLETED	Automatic (COMPLETE)	Process report (enabled only for transition based on command)
PROCESSING STOPPED	Automatic (STOP)	Process report (enabled only for transition based on command)
PROCESSING STATE SETUP	Automatic (->SETUP)	Processing state report
PROCESSING STATE READY	Automatic (->READY)	Processing state report
PROCESSING STATE EXECUTING	Automatic (->EXECUTING)	Processing state report
PROCESSING STATE IDLE	Automatic (->IDLE)	Processing state report
PROCESSING STATE PAUSE	Automatic (->PAUSE)	Processing state report
ALARM DETECTED	Automatic (ALARM n occurred)	Alarm report (defined only for alarms required by event)
ALARM CLEARED	Automatic (ALARM n cancelled)	Alarm report (defined only for alarms required by event)
EQUIPMENT CONSTANT CHANGE	Automatic (Equipment constant change)	Equipment constant change report
LIMIT ZONE TRANSITION	Automatic (Transition within LIMIT area)	Limit transition report (defined for each limit variable)
PROCESS PROGRAM CHANGE	Automatic (Process Program change)	Process program change report
PROCESS PROGRAM SELECTED	Automatic (Process Program selection)	Process program selection report
MATERIAL RECEIVED	Relay request	Time report
MATERIAL REMOVED	Relay request	Time report
SPOOLING ACTIVATED	Automatic (SPOOL INACTIVE->SPOOL ACTIVE)	Spool start report
SPOOLING DEACTIVATED	Automatic (SPOOL ACTIVE->SPOOL INACTIVE)	Spool stop report
SPOOL TRANSMIT FAILURE	Automatic (SPOOL transmission failure)	Spool transmission failure report
MESSAGE RECOGNITION	Relay request	Time report

8.15 DYNAMIC SETTING CHANGE

Series	SECS/GEM communication software		
	Non-GEM version	GEM version	GEM advanced version
MELSEC-Q series	—	○	○
MELSEC iQ-R series	—	○	○

The SECS/GEM communication software can change settings dynamically from the host by using the following messages.

- S2F33 (Define Report)
- S2F35 (Link Event Report)
- S2F37 (Enable/Disable Event Report)
- S2F43 (Reset Spooling Streams and Functions (RSSF))
- S2F45 (Define Variable Limit Attributes)
- S5F3 (Enable/Disable Alarm Send)

Content for which settings have been changed dynamically from the host can be saved to the SECS/GEM communication software pre-installed model module and acquired and referenced by the setting tool.

Point

Check the [GEM Function]⇒[Create Dynamic Configuration File] option to store dynamic setting changes in the SECS/GEM communication software.

Window

[GEMFunction] ⇒ [Acquire Dynamic Configuration File]

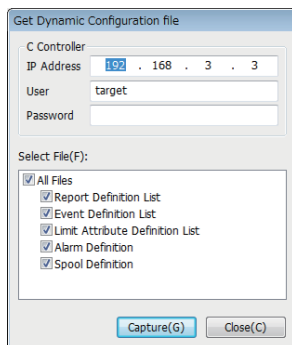

Operating procedure

1. Enter the IP address, user, and password of the SECS/GEM communication software pre-installed model module.
2. Select the checkboxes of the files to be acquired from the SECS/GEM communication software pre-installed model module.
3. Click the [Capture] button.

8.16 EQUIPMENT CONSTANT

Series	SECS/GEM communication software		
	Non-GEM version	GEM version	GEM advanced version
MELSEC-Q series	—	○	○
MELSEC iQ-R series	—	○	○

Configure the necessary settings to change equipment variables (ECV) from the host and report changes of equipment variables from the equipment to the host.

Change from device

Configure the setting to notify the SECS/GEM communication software from the programmable controller CPU of a change of the equipment constant.

Window

[GEMData] ⇔ [Device Constant] ⇔ [Change From Device] tab

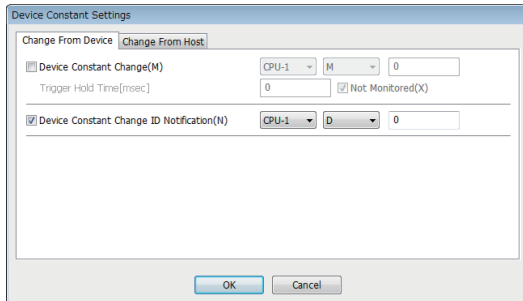

Displayed items

Item	Description
Device constant change trigger	<p>—</p> <p>Configure the relay to notify the SECS/GEM communication software from the programmable controller CPU of a change of the equipment variable. The SECS/GEM communication software switches OFF the equipment variable change trigger.</p>
Trigger Hold Time	<p>A notification trigger results when the register configured for the Device Constant Change was held for the configured time. If the "Not Monitored" checkbox is selected, notification trigger processing is carried out without hold monitoring.</p>
Device constant change ID notification	<p>Configure the equipment constant change ID notification register to store the variable ID of the changed constant. Before a trigger notification, it is necessary to configure the variable ID at the programmable controller CPU.</p>

Change from host

Configure the settings when the equipment constant is changed from the host.

Window

[GEMData] ⇒ [Device Constant] ⇒ [Change From Host] tab

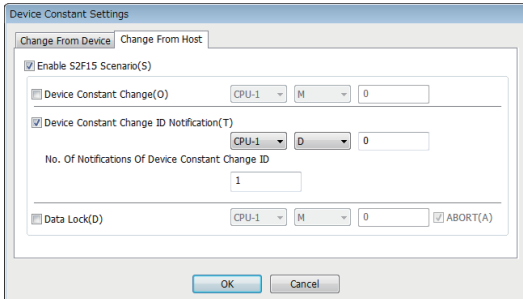

Displayed items

Item	Description
Enable S2F15 scenario	Select this checkbox to change the equipment constant from the host.
Device constant change trigger	Defines the relay used by SECS/GEM communication software to notify the Programmable Controller CPU that S2F15 (New Equipment Constant Send) is received.
Device constant change ID notification	Configure the register to store the variable ID of the changed constant.
No. of Device constant change ID notifications	Configure the number of equipment variables that can be changed at one time by an S2F15 (new equipment variable change) from the host. Up to 32 items can be configured.
Data lock	To block changes of equipment variables from the host, switch ON the data lock relay from the programmable controller CPU. Select the "ABORT" checkbox to return an abort message.

Required Quantity of Device Constant Change ID Notification Registers

The required quantity of registers is found by the following formula: 2 start items (number of changes n, overall result) + (device constant change ID notification quantity × 2)

However, when the data type of ECID (equipment constant ID) is [U4], the formula is as follows: 2 start items (number of changes, overall result) + (equipment variable change ID notification quantity × 3)

The data type of the ECID can be checked at the [SECS item] of the "Detailed Setting" screen. (Page 216 SECS items)

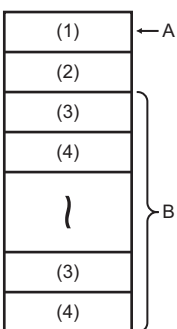

A: Start register

B: No. of Notifications Of Device Constant Change ID

(1) Number of changes n

(2) Overall result (0: normal / -1: error)

(3) Equipment constant ID

(4) Results

Precautions

The changed equipment constant is not saved to the memory card of the SECS/GEM communication software pre-installed model module.

Please assign the Equipment constant to the File register if required to save.

8.17 ADVANCED SETTINGS

Series	SECS/GEM communication software		
	Non-GEM version	GEM version	GEM advanced version
MELSEC-Q series	—	○	○
MELSEC iQ-R series	—	○	○

Make settings required to implement the various scenarios defined in GEM.

Multi-block

If messages from device or host are exchanged across multiple blocks, it is necessary to implement multi-block inquiry in advance.

Window

[GEMData] ⇒ [Details] ⇒ [Multi-Block] tab

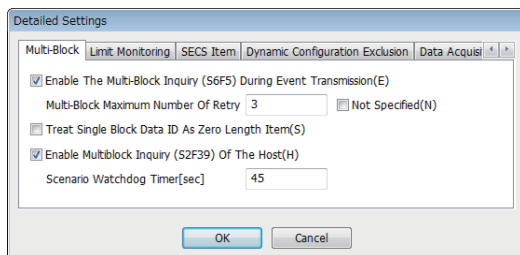

Displayed items

Item	Description
Enable multi-block inquiry (S6F5) during event transmission	Select this checkbox if it is necessary to send an S6F5 (multi-block data sending inquiry) at the time of an S6F11 (event report sending). The maximum number multi-block retries is 32.
Treat single block data ID as Zero length item	Select this checkbox to treat the item <DATAID> of an S6F11 (event report sending) to be sent in single block as a zero length item.
Enable multi-block inquiry of the host (S2F39)	Select this checkbox if an S2F39 (multi-block inquiry) may be received ahead of receiving the following messages from the host. S2F33 (Define Report) S2F35 (Link Event Report) S2F45 (Define Variable Limit Attributes) S2F49 (Enhanced Remote Command) Whether all messages are received within a time set for "Scenario Watchdog Timer" is monitored. If a timeout occurs, S9F13 (Conversation Timeout) is automatically sent. The item data in this case shall be "S2" for <MEXP> and the target DATAID for <EDID>. The Scenario Watchdog Timer can be configured up to 999 seconds.

Multi-block inquiry

Please note the following about the Multi-block inquiry of the host.

- S2F23 (trace condition configuration) is a message subject to multi-block by SEMI E5, but the SECS/GEM communication software cannot receive multi-blocks because <DATAID> has not been attributed.

Limit monitoring

The SECS/GEM communication software configures the sampling cycle to monitor the limits of variables.

Window

[GEMData] ⇒ [Details] ⇒ [Limit Monitoring] tab

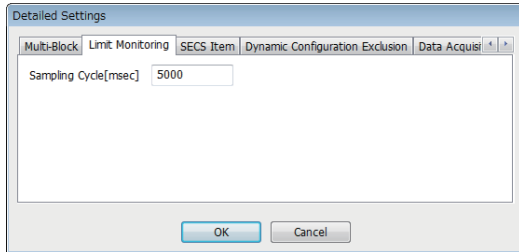

Displayed items

Item	Description
sampling period	Configure the cycle to monitor devices that store variable values. The sampling cycle can be configured from 1000 through 4294967295 ms. This setting is reflected in the equipment variable LimitsSamplingInterval.

SECS items

Configure the SECS-data item-format used by the SECS/GEM communication software.

Window

[GEMData] ⇒ [Details] ⇒ [SECS Item] tab

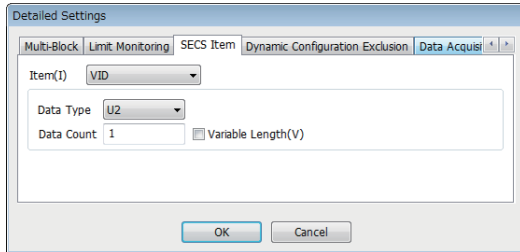

Displayed items

Item	Description
Item	— Select an item to be defined.
Data Type	Select the data type of the item.
Data Count	Configure the data count of the item.
Variable Length	Select this checkbox to configure the data count to a variable length. Configuring a variable length enables 0 length reception.

Default data type of SECS items

The following table shows default formats by item.

Item	Description	Data type
VID	Variable ID	U2
UNITS	Unit	ASCII 16Byte
ECID	Equipment constant ID	U2
ECNAME	Equipment constant name	ASCII 32Byte
SVID	State variable ID	U2
SVNAME	State variable ID	ASCII 32Byte
CEID	Acquired event ID	U2
RPTID	Report ID	U2
CEED	Trace YES/NO code	BOOL
DATAID	Data ID	U2
DATALENGTH	Total no. of data bytes	U2
TRID	Trace request ID	U2
DSPER	Data acquisition time	ASCII 8Byte
TOTSMP	Total sample count	U2
REPGSZ	Report group size	U2
SMPLN	Sample number	U2
LIMITID	Limit ID	BIN
MEXP	Message SxFy to be received	ASCII 6Byte

Dynamic setting exclusion

This setting is used to enable host to notify Programmable Controller CPU that event report pertaining to the equipment etc. is subjected to dynamic changes, and in order to enable Programmable Controller CPU to prohibit host from introducing dynamic changes.

Window

[GEMData] ⇒ [Details] ⇒ [Dynamic Configuration Exclusion] tab

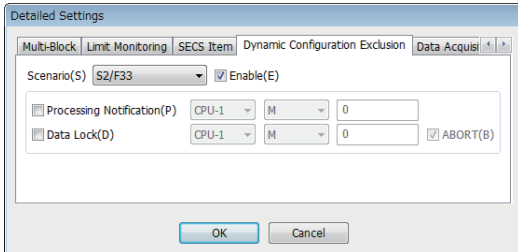

Displayed items

Item		Description
Scenario	—	Select a scenario. The following scenarios can be selected. <ul style="list-style-type: none"> • S2F33: Specified report • S2F35: link event report • S2F37: enable/disable event report • S2F45: variable limit attribute definition
	Enable	Select this checkbox to enable dynamic configuration exclusion control of scenarios.
	Processing notification	Configure the relay for the SECS/GEM communication software to notify the programmable controller CPU that processing is occurring for each scenario.
	Data lock	To lock changes when a change notification of a dynamic setting is received from the host, the data lock relay is used, and this relay is turned ON from the Programmable Controller CPU. Lock cannot be enabled after receiving the change notification message from the host. The lock should be turned ON in advance based on the equipment state. Select the "ABORT" checkbox to return an abort message.

Data acquisition exclusion

Configure to notify the programmable controller CPU that data, such as equipment variables, is being collected from the host to the equipment and to prohibit data collection by the host from the programmable controller CPU.

Window

 [GEMData] ⇒ [Details] ⇒ [Data Acquisition Exclusion] tab

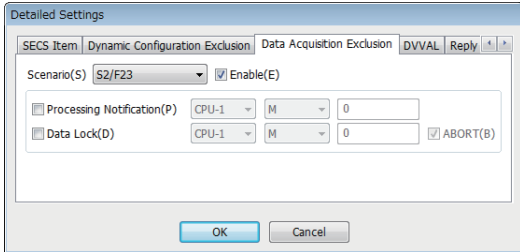

Displayed items

Item	Description
Scenario	<p>Select a scenario.</p> <p>The following scenarios can be selected.</p> <ul style="list-style-type: none"> • S2F23: Trace condition setting • S6F15: Event report request • S6F19: Individual report request • S1F3: Specified device state request • S1F11: State variable name list request • S2F13: Equipment constant request • S2F29: Equipment constant name list request • S2F47: Variable limit attribute request
Enable	Select this checkbox to enable data collection exclusion control of scenarios.
Processing notification	Configure the relay for the SECS/GEM communication software to notify the programmable controller CPU that processing is occurring for each scenario.
Data lock	<p>Select this checkbox to turn the data lock relay ON from the programmable controller CPU when locking data collection from the host.</p> <p>Lock cannot be enabled after receiving the acquisition message from the host.</p> <p>The lock should be turned On in advance based on the equipment state.</p> <p>Select the "ABORT" checkbox to return an abort message.</p>

DVVAL

Configure the conditions to disable the variables of the DVVAL class.

Window

 [GEMData] ⇒ [Details] ⇒ [DVVAL] tab

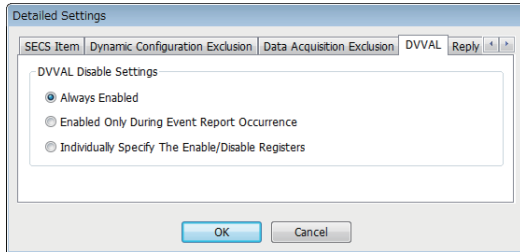

Displayed items

Item		Description
DVVAL Disable Settings	Always Enabled	Select to have the variables of the DVVAL class always enabled. Actual data is sent when sending an S6F11/S6F16/S6F20.
	Enabled only During Event Report Occurrence	Select to have the variables of the DVVAL class enabled only for S6F11 sending. When reporting in S6F16 and S6F20, send it as a 0 length item.
	Individually Specify The Enable/Disable Registers	Select to specify enable/disable for registers individually and dynamically for variables of the DVVAL class. The first word of the specified register is used as the enable/disable register for all user-defined variables that specify the DVVAL class. The actual data is stored in the first + one word. The Enable/disable register specifies "1" if the variable is valid, and "0" from the Programmable Controller CPU if it is disabled.

Reply Setting

Set the W-bit of S6F1 message.

Window

[GEMData] ⇒ [Details] ⇒ [Reply Setting] tab

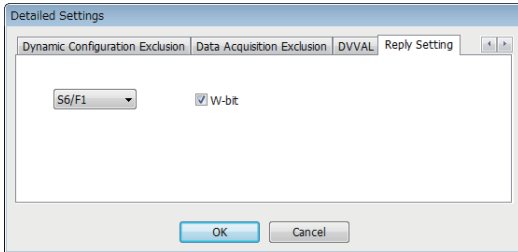

Displayed items

Item	Description
W-bit	Select this checkbox to send an S6F1 message with a W-bit.

8.18 GEM COMPLIANT TABLE

Series	SECS/GEM communication software		
	Non-GEM version	GEM version	GEM advanced version
MELSEC-Q series	—	—	○
MELSEC iQ-R series	—	—	○

Configure whether to comply with the items of the basic requirements and additional performance of GEM.

This setting is applied to the GEM compliant table that is output by the documentation function.

GEM compliant table is created based on the functions specified in "GEM performance definition" screen and based on contents specified in the original GEM compliant table.

Window

 [Documentation] ⇒ [GEM Compliant Table]

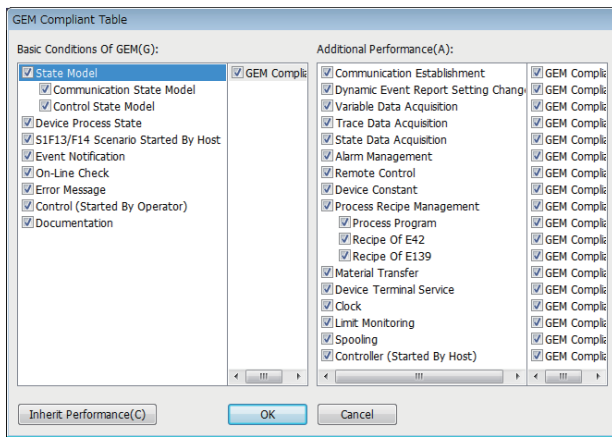

Select the checkboxes of compliant items.

To update and retain details displayed on "GEM performance definition" screen as it is, press [Retain performance] button.

9 SECS/GEM Communication Software Knowledge

This section describes the points and knowledge to conveniently use SECS/GEM communication when using SECS/GEM communication software.

9.1 Checking that start-up of the SECS/GEM communication software completed

Series	SECS/GEM communication software		
	Non-GEM version	GEM version	GEM advanced version
MELSEC-Q series	<input type="radio"/>	<input type="radio"/>	<input type="radio"/>
MELSEC iQ-R series	<input type="radio"/>	<input type="radio"/>	<input type="radio"/>

In the case of a ladder program of a programmable controller CPU, always first make sure that the [CIM Control READY] relay that reports from the SECS/GEM communication software is ON after starting the SECS/GEM communication software. When the start-up process of the SECS/GEM communication software finishes, the CIM Control READY relay switches ON. A handshake with SECS/GEM communication software cannot be used until this relay switches on.

Usage method

To use notification of the CIM control ready relay, it is necessary to configure the relay to report. (☞ Page 82 CA Status)
After the SECS/GEM communication software starts, first make sure that the CIM control ready relay is ON.
A handshake with SECS/GEM communication software cannot be used until the [CIM Control READY] notification relay turns ON.

9.2 Checking the SECS line state

Series	SECS/GEM communication software		
	Non-GEM version	GEM version	GEM advanced version
MELSEC-Q series	<input type="radio"/>	<input type="radio"/>	<input type="radio"/>
MELSEC iQ-R series	<input type="radio"/>	<input type="radio"/>	<input type="radio"/>

The connection state of the SECS communication line is reported by the Disconnected relay. This relay turns OFF when the line is connected and turns ON when the line is disconnected. In the case of HSMS communication, the TCP/IP communication line is established, the "select" control procedure is completed via a HSMS message, and then a line connection is created by the Selected state. In the case of SECS-I communication, a line connection is created when the RS-232C line is completely opened.

Usage method

To use notification of the Disconnected relay, it is necessary to configure the relay to report. (☞ Page 82 CA Status)

Precautions

The line connection state of the SECS communication line can be checked by the Disconnected relay. In the case of HSMS communication, a line connection state is not formed by just a TCP/IP line connection.

9.3 Checking the registration state of the SECS/GEM communication software license

Series	SECS/GEM communication software		
	Non-GEM version	GEM version	GEM advanced version
MELSEC-Q series	<input type="radio"/>	<input type="radio"/>	<input type="radio"/>
MELSEC iQ-R series	<input type="radio"/>	<input type="radio"/>	<input type="radio"/>

The SECS/GEM communication software license is pre-installed on the SECS/GEM communication software pre-installed model module, but the license is erased when the SECS/GEM communication software pre-installed model module has been initialized.

In such a case, you must use the license file stored on the product CD-ROM to register the license again.

If the license state notification function is used, an automatic stop of the SECS/GEM communication software due to a license registration error can be detected in advance.

Usage method

To use notification of the license state, it is necessary to configure the relay and register to report. (📖 Page 96 Version Information)

Configuring the setting makes it possible to check the following states.

License state	Notification content
Version Information	The version of the SECS/GEM communication software is stored as an ASCII character string (null termination). Five words are used.
License Registration	The registration state of the license file is reported by relay. 0: No registration 1: Registration
License Matching	The validity of the license file is reported by relay. 0: Non-genuine license 1: Genuine license

When the License Registration and License Matching relays are both ON, a genuine license has been registered.

Whether a genuine license has been registered can be determined by the [License Matching] relay.

9.4 Sending and receiving messages

Series	SECS/GEM communication software		
	Non-GEM version	GEM version	GEM advanced version
MELSEC-Q series	<input type="radio"/>	<input type="radio"/>	<input type="radio"/>
MELSEC iQ-R series	<input type="radio"/>	<input type="radio"/>	<input type="radio"/>

The SECS/GEM communication software sends and receives SECS messages by handshakes of trigger relays from the Programmable Controller CPU and the data register.

The format of messages to be sent and received, sending and receiving trigger relays, and mapping of sending and receiving message items with storage registers must be defined in advance using the setting tool.

Understand the basic structure of SECS message sending and receiving by the SECS/GEM communication software before using the message sending and receiving function.

Usage method

■Receiving SECS messages

When an SECS message is received from the host, the SECS/GEM communication software stores the received data in the prescribed register mapped to the corresponding message item, and then the receiving notification trigger relay configured for the corresponding message is switched on.

The Programmable Controller CPU detects that a message was received by the receiving notification trigger being switched on, and then extracts the received data from the register. Next, the receiving notification trigger is switched off, and the SECS/GEM communication software is informed that receipt is complete.

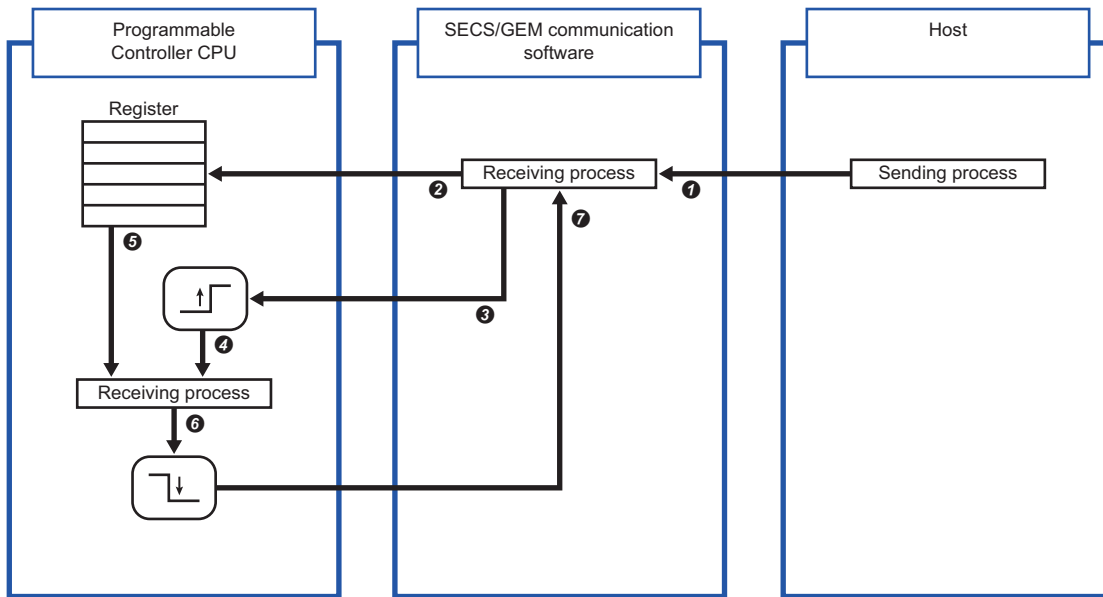

No.	Description
①	The SECS/GEM communication software receives a SECS message
②	The received data is stored in the register specified by the item property definition of the message (📖 Page 55 Item Information)
③	The reception notification trigger relay of the programmable controller CPU specified by the message property definition is switched ON (📖 Page 52 Message Information)
④	The programmable controller CPU detects the message reception by the reception notification trigger relay switching ON
⑤	Received data is read from the register
⑥	After the received data is read, the reception notification trigger relay is switched OFF
⑦	The programmable controller reports receipt completion to the SECS/GEM communication software

The reception notification trigger relay is configured at the "Primary message information" screen or "Secondary message information" screen. Select the "Reception Notification Trigger" checkbox, and then configure the notification destination.

(📖 Page 52 Message Information)

■ Sending SECS messages

When an SECS message is sent from programmable controller CPU to the host, the sent data is stored in the prescribed register mapped to the corresponding sending message item, and then the sending request trigger relay configured for the corresponding message is switched ON.

The SECS/GEM communication software detects that the transmission request trigger relay is on, extracts the data of the corresponding message item from the configured prescribed register, creates an SECS message, and then sends the message to the host according to the SECS protocol. After sending, the transmission request trigger relay is switched off, and the Programmable Controller CPU is notified of the completion of sending.

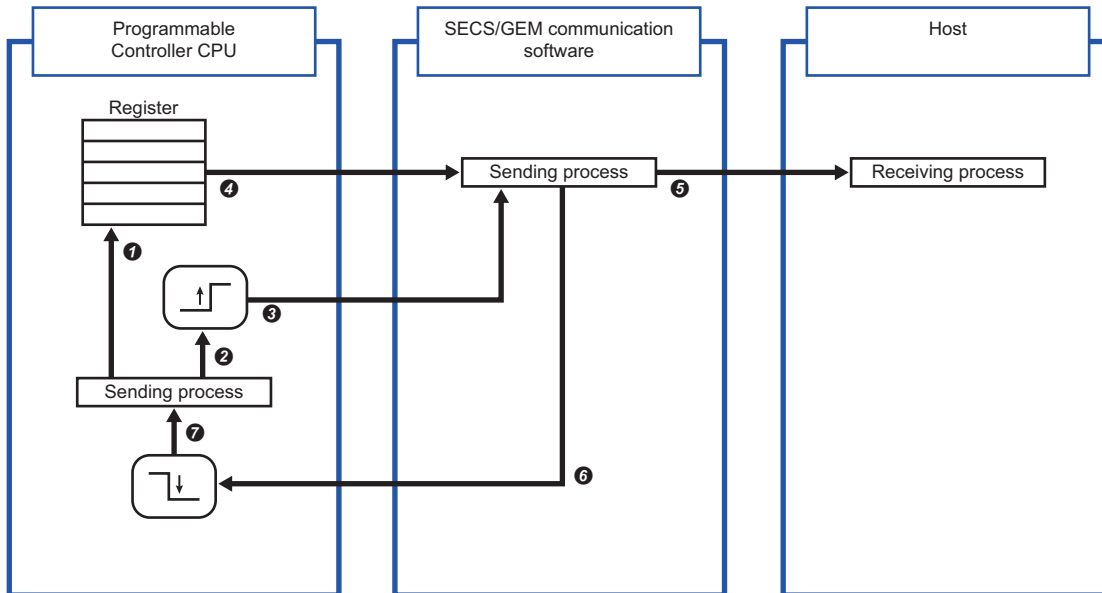

No.	Description
①	The sent data is stored in the register specified by the item property definition (Page 55 Item Information)
②	The sending request trigger relay specified by the message property definition is switched ON (Page 52 Message Information)
③	The SECS/GEM communication software detects storage of sent data to the register from the sending request trigger relay of the programmable controller CPU switching ON
④	The SECS/GEM communication software reads the sent data from the register of the programmable controller CPU
⑤	The SECS/GEM communication software constructs a SECS message based on the imported data, and then sends it to the host
⑥	The sending request trigger relay of the programmable controller CPU switches OFF
⑦	Sending completion is reported to the programmable controller CPU by the sending request trigger relay switching OFF

The sending request trigger relay is configured at the "Primary message information" screen or "Secondary message information" screen. Select the "Transmission Request Trigger" checkbox, and then configure the notification destination. ([Page 52 Message Information](#))

Point

- Configure the transmission request trigger hold time at the message settings screen of the scenario explorer.
The SECS/GEM communication software confirms that the time trigger relay configured here is ON before it recognizes that the relay is ON.
- To notify of an error during SECS communication, configure it at the [SECS Error Notification Setting] tab of the "Option Setting" screen. Select the checkboxes for information to be reported, and then configure the notification destination. ([Page 82 CA Status](#))
In the case of a sending failure, select the [Sending failure] checkbox, and then configure the relay for reporting.

Important points regarding message sending and receiving handshakes

- When sending consecutive messages, make sure that the sending request trigger relay of the previous message is OFF before switching ON the sending request trigger relay of the next message.
- Set a 20 ms trigger hold time for the transmission request trigger of the secondary message after receipt of the primary message. This allows the SECS/GEM communication software to be notified that the primary message receiving notification trigger relay is off before the notification that the transmission request trigger relay of the secondary message is on.
- When sending has failed, the sending request trigger relay is switched OFF. The sending-failed relay switches ON. The programmable controller CPU must not only switch OFF the sending request trigger relay, it must also monitor that the sending failure relay is ON.

9.5 Sending alarm messages (S5F1)

Series	SECS/GEM communication software		
	Non-GEM version	GEM version	GEM advanced version
MELSEC-Q series	<input type="radio"/>	<input type="radio"/>	<input type="radio"/>
MELSEC iQ-R series	<input type="radio"/>	<input type="radio"/>	<input type="radio"/>

When an alarm message (S5F1) is sent from the Programmable Controller CPU, the SECS/GEM communication software notifies the host of the alarm message automatically simply by Alert Status and a handshake operation of Alert Set/Reset Notification, without defining multiple alarm messages as transactions.

Usage method

■ Alarm information definitions

Alarms to be disclosed by the equipment are defined by the setting tool in advance.

Each alarm is managed by a unique identifier and alarm number appended to each alarm. The SECS/GEM communication software and Programmable Controller CPU transfer the alarm state by setting the "Alarm No." as a key.

The alarm information is configured as shown below.

- Non-GEM version: configured at the "Alarm Settings" screen. (☞ Page 102 Alarm Settings)
- GEM version and advanced GEM version: configured at the "Alarm Definition" screen. (☞ Page 176 Alarm Definition)

■ Alarm notification settings

Configure the handshake to report the alarm.

Setting item	Setting content
Alarm Notification Setting *1	Select the checkbox.
Alarm Set Notification	Configure the relay to report the alarm occurrence.
Alarm Reset Notification	Configure the relay to report the alarm reset.
Alarm Status (Start)	Specify the first register of alarm status information to retain the alarm status.
Number Of Alarm Status	Specify the size of the alarm status information by word count. Because alarm statuses are retained by a bit map, one word retains 16 alarm statuses.

*1 Configure the non-GEM version only.

Handshakes are configured as shown below.

- Non-GEM version: configured at the "Alarm Notification Setting" screen. (☞ Page 103 Alarm Notification Setting)
- GEM version and advanced GEM version: configured at the "Alarm Settings" screen. (☞ Page 177 Common Alarm Settings)

Alarm status

The alarm information retains the alarm states as bits.

Each word retains 16 alarm statuses, and the alarm Status 0 and 1 indicate reset and occurrence, respectively.

Register	b15	b14	b13	b12	b11	b10	b9	b8	b7	b6	b5	b4	b3	b2	b1	b0
+0W	No.16	No.15	No.14	No.13	No.12	No.11	No.10	No.9	No.8	No.7	No.6	No.5	No.4	No.3	No.2	No.1
+1W	No.32	No.31	No.30	No.29	No.28	No.27	No.26	No.25	No.24	No.23	No.22	No.21	No.20	No.19	No.18	No.17
+2W	No.48	No.47	No.46	No.45	No.44	No.43	No.42	No.41	No.40	No.39	No.38	No.37	No.36	No.35	No.34	No.33
+3W	No.64	No.63	No.62	No.61	No.60	No.59	No.58	No.57	No.56	No.55	No.54	No.53	No.52	No.51	No.50	No.49

Alarm report procedure

The following diagram shows the sequence of reporting the alarms of Alarm No. 10 (alarm 10) and Alarm No. 20 (alarm 20). In the case of an alarm reset, the alarm status is set to 0 (reset), and then Alarm Reset Notification is switched ON.

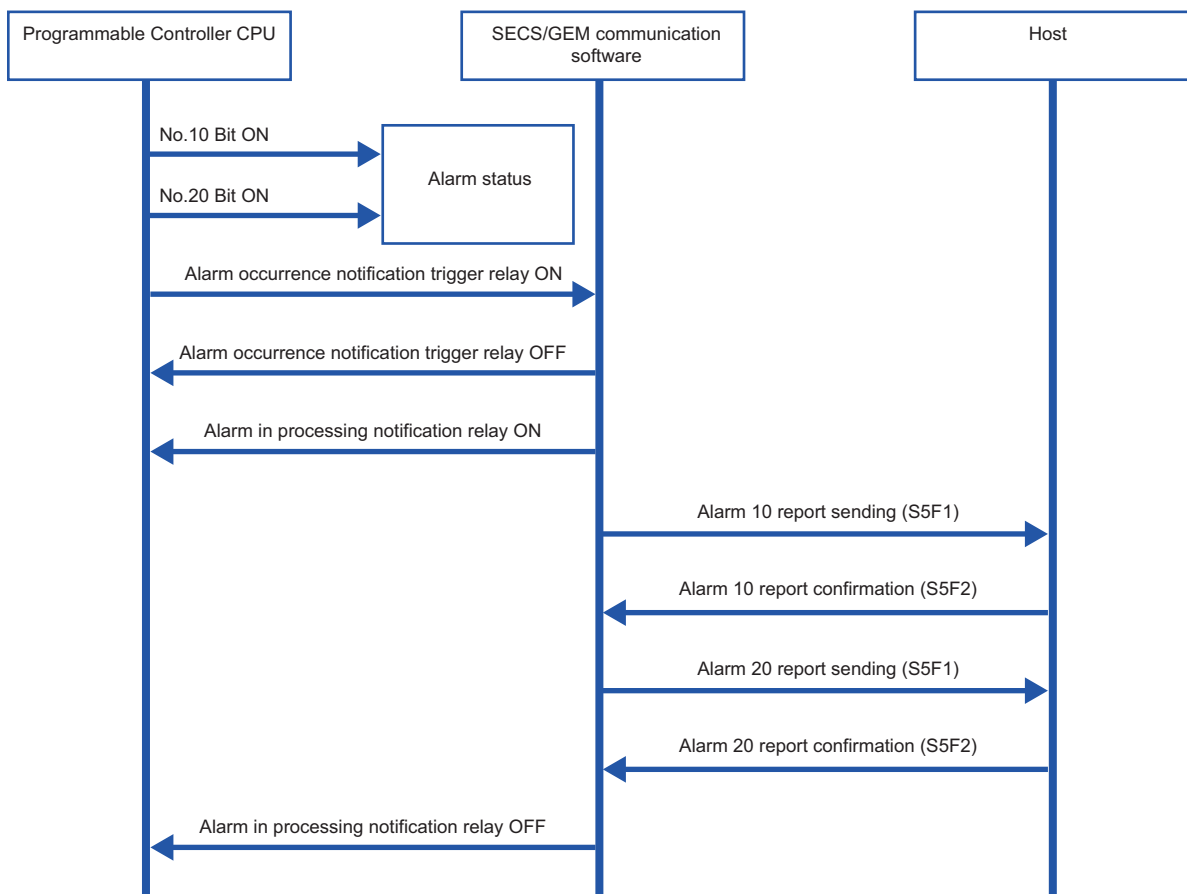

Precautions

- When multiple alarms are reported by the set/reset notification triggers simultaneously, the alarms are sent in order from the alarm with the lowest alarm number.
- Considering the load of the number of alarms to be reported simultaneously, set the number of alarms to the lowest value possible.

9.6 Using the spool function

Series	SECS/GEM communication software		
	Non-GEM version	GEM version	GEM advanced version
MELSEC-Q series	○	○	○
MELSEC iQ-R series	○	○	○

Of the messages to be reported to the host, the spool function temporarily saves messages that must not be lost due to communication failure at the equipment, and then reports the saved messages to the host when communication is restored. Configure messages that must not be lost (primary messages) to be subject to spooling.

When a message subject to spooling fails to be sent, the message is saved in the spool queue. Once communication is restored, the message saved in the spool queue is sent back or discarded by a Spooled data request (S6F23) from the host.

Operation

The following figure shows the spooling operation sequence.

Both Message 1 and Message 2 are configured for spooling.

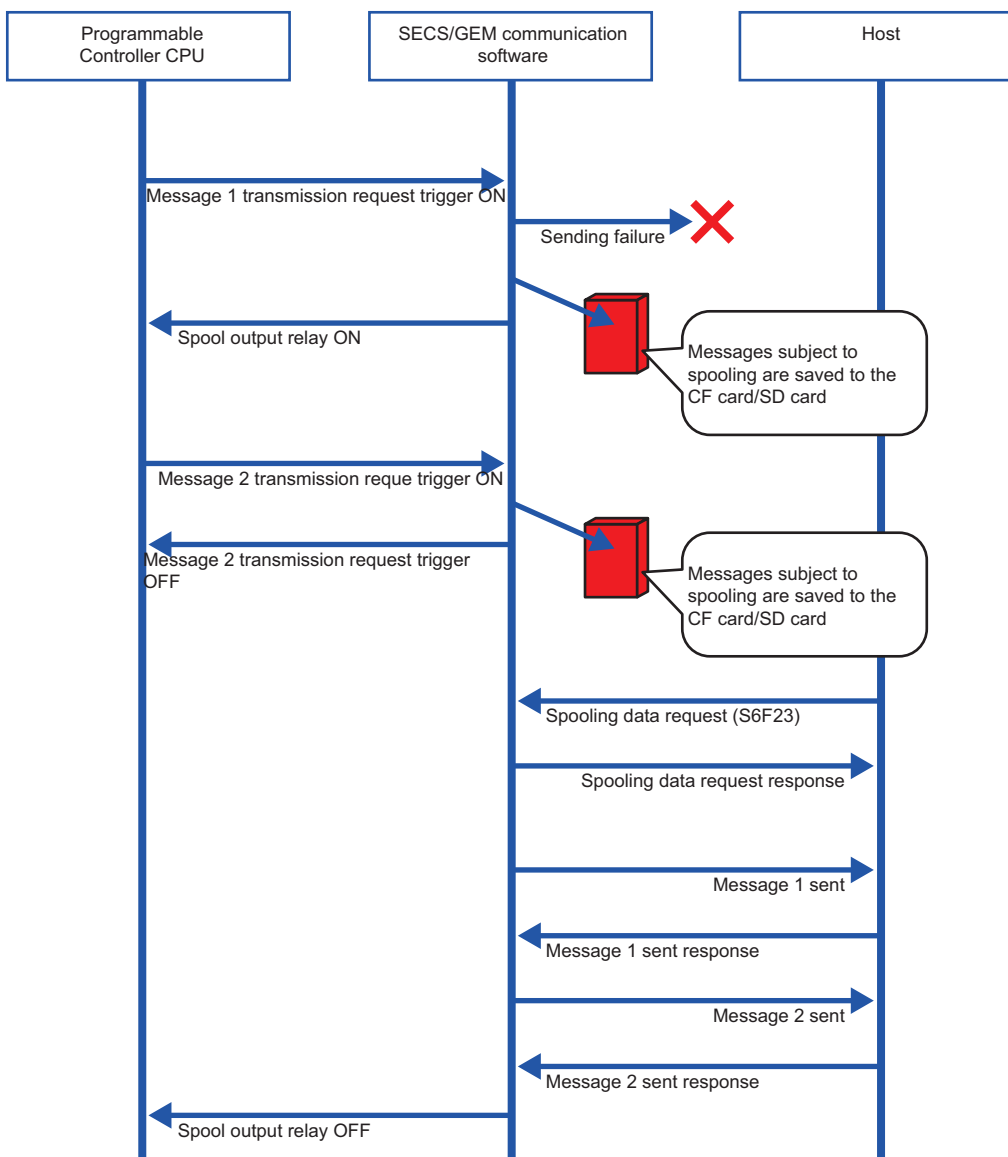

Usage method (non-GEM version)

■Configuring messages for spooling

Configure messages subject to spooling at the [Spool Message Settings] tab of the "Spool Settings" screen. (☞ Page 108 Spool message settings)

Select a message to be subject to spooling from the pull-down list of [Message selection] and click the [Add] button to configure the selected message for spooling.

■Configuring the spooling function

Configure the spooling function at the [Common Spool Definition Settings] tab of the "Spool Settings" screen. (☞ Page 106 Common Spool Definition settings)

■Turning spooling on or off

Configure the setting to enable or disable the spooling function at the [Control Request] tab of the "Option Setting" screen. (☞ Page 85 Control Request)

To toggle spooling at the equipment, select the [Turn spooling on/off] checkbox, and then configure the relay to turn spooling on or off.

The spool is OFF or ON when the relay is OFF or ON, respectively.

If the "Turn spooling on" checkbox is not selected, the spool is always active.

■Spooling actions

Configure the Spool Outputting Relay at the [CA Status] tab of the "Option Setting" screen. Select the "Spool Outputting Relay" checkbox, and then configure the notification destination. (☞ Page 82 CA Status)

■Spooling data request from Programmable Controller CPU

Configure the Spool Request Relay at the [Control Request] tab of the "Option Setting" screen. (☞ Page 85 Control Request)

Spooling data can also be sent to the host or discarded by operations via trigger relays from the Programmable Controller CPU.

If the "Spool Output Request" checkbox is selected, and a trigger relay is configured, spooling data transfer to the host is started when the trigger relay is on. The SECS/GEM communication software switches off the trigger relay.

If the "Discard Spooled Data" checkbox is selected, and a trigger relay is configured, spooled data is discarded when the trigger relay is on. The SECS/GEM communication software switches off the trigger relay.

Usage method (GEM version and GEM ADVANCED version)

■Configuring messages for spooling

Configure messages subject to spooling at the "Spool List" screen. Double-click a row inserted by using the shortcut menu of the Spool List to display the "Spool Definition" screen, and then define the messages subject to spooling. (☞ Page 180 Spool list)

■Configuring the spooling function

Configure the spooling function at the [Common] tab of the "Spool Settings" screen. (☞ Page 182 Common)

■Turning spooling on or off

Configure the setting to enable or disable the spooling function at the [Common] tab of the "Spool Settings" screen. If "1: Enable" is selected for "Enable Spooling", the spool is active. (☞ Page 177 Common)

9.7 Changing the communication settings from the ladder program

Series	SECS/GEM communication software		
	Non-GEM version	GEM version	GEM advanced version
MELSEC-Q series	<input type="radio"/>	<input type="radio"/>	<input type="radio"/>
MELSEC iQ-R series	<input type="radio"/>	<input type="radio"/>	<input type="radio"/>

You can change the SECS communication settings via a handshake with the SECS/GEM communication software. Use this procedure when changing the communication settings from the equipment.

Usage method

■Communication settings change handshake settings

Configure the handshake interface for a communication setting change at the "Communication Setting By PLC" screen. ( Page 63 Communication Setting by PLC)

Select the "Communication Setting by PLC" checkbox, specify the setting request trigger, and then configure the storage address of each communication setting.

IP addresses use four words.

For details of IP addresses made up of four words, see the following reference.

 Page 118 IP address information

The SECS/GEM communication software changes the communication settings when the setting request trigger is on, and then switches off the setting request trigger.

Note that changes to the communication settings are applied the next time the SECS/GEM software is started.

When SECS/GEM communication software is started, the communication setting information set in the SECS/GEM communication software pre-installed model module is stored in each piece of information of the communication settings.

Considerations

- Whether the settings are HSMS or SECS-I, they are determined by "Port Type" at the "Communication Setting" screen displayed by selecting [Settings] ⇒ [Communication Setting] in the menu.
- The communication settings are applied the next time the SECS/GEM software is started.

9.8 Using the mapping function

Series	SECS/GEM communication software		
	Non-GEM version	GEM version	GEM advanced version
MELSEC-Q series	<input type="radio"/>	<input type="radio"/>	<input type="radio"/>
MELSEC iQ-R series	<input type="radio"/>	<input type="radio"/>	<input type="radio"/>

For example, host command sending messages (S2F41) have different parameter (CPNAME, CPVAL) numbers and targets due to the remote command (RCMD), even when the message structure is the same.

If the mapping function is applied to these messages, message sending request trigger relays and reception notification trigger relays of each parameter of key items and offsets for control registers of message items can be configured in one transaction definition.

Therefore, the reference destination or storage destination of parameters can be changed by the values of particular key items.

Point

Example of locations for applying mapping function

- Mapping host command sending messages (S2F41) by remote command
- Mapping the data of discrete variable data sending messages (S6F3) to message data by load port

Usage method

Configure messages for command mapping in the mapping settings, and then configure command parameters.

■ Mapping settings

Mapping settings can be configured at the "Command Setting" screen. ( Page 120 Command Setting)

Under "Message", select the message to be command mapped from the pull-down list. Under "Key Item", select the item to be the mapping key from the pull-down list.

When offsets will be applied to secondary messages as well, select the "Use the same offset for secondary messages" checkbox.

■ Parameter settings (mapping settings by parameters of key items)

At the "Parameter Setting" screen, configure offsets message sending request trigger relays, reception notification trigger relays, and offsets for control registers of message items for each parameter of key items. ( Page 121 Parameter setting)

Usage example

The host controls the equipment using the four host command sending messages (S2F41) described below. Each message has different command parameters <CPNAME> and <CPVAL> for each remote command <RCMD>. A remote command <RCMD> is set as a key item, and reception notification trigger relays, sending request trigger relays, and offsets of control registers are mapped to each remote command <RCMD>.

■Board retrieval message

The equipment retrieves the board of the specified slot from the carrier placed in the specified load port, and then sets the board in the specified equipment processing unit.

The message has three parameters

Message format	Item value	Notes
<HCS>		
<L, 2>		
1. ASCII <RCMD>	LOAD	Board retrieval command
2. <L, 3>		Number of parameters
1. <L, 2>		
1. ASCII <CPNAME1>	PORT	Load port number parameter name
2. U2 <CPVAL1>	1 to 2	Load port number
2. <L, 2>		
1. ASCII <CPNAME2>	SLOT	Slot number parameter name
2. U2 <CPVAL2>	1 to 4	Slot number
3. <L, 2>		
1. ASCII <CPNAME3>	PNO	Equipment processing unit number parameter name
2. U2 <CPVAL3>	1 to 2	Equipment processing unit No.

■Processing-start message

The equipment performs processing using the specified temperature and pressure parameters at the processing unit specified by the host.

The message has three parameters.

Message format	Item value	Notes
<HCS>		
<L, 2>		
1. ASCII <RCMD>	START	Processing-start command
2. <L, 3>		Number of parameters
1. <L, 2>		
1. ASCII <CPNAME1>	PNO	Equipment processing unit number parameter name
2. U2 <CPVAL1>	1 to 2	Equipment processing unit No.
2. <L, 2>		
1. ASCII <CPNAME2>	TEMP	Temperature parameter name
2. U2 <CPVAL2>	0 to 800	Temperature
3. <L, 2>		
1. ASCII <CPNAME3>	PRESS	Pressure parameter name
2. U2 <CPVAL3>	2000 to 8000	Pressure

■ Processing-stop message

The equipment stops current processing at the processing unit specified by the host.

The message has one parameter.

Message format	Item value	Notes
<HCS>		
<L, 2>		
1. ASCII <RCMD>	STOP	Processing-stop command
2. <L, 1>		Number of parameters
1. <L, 2>		
1. ASCII <CPNAME1>	PNO	Equipment processing unit number parameter name
2. U2 <CPVAL1>	1 to 2	Equipment processing unit No.

■ Board withdrawal message

The equipment withdraws the board of the processing unit specified by the host to the specified slot of the carrier of the specified load port.

The message has three parameters.

Message format	Item value	Notes
<HCS>		
<L, 2>		
1. ASCII <RCMD>	UNLOAD	Board withdrawal command
2. <L, 3>		Number of parameters
1. <L, 2>		
1. ASCII <CPNAME1>	PORT	Load port number parameter name
2. U2 <CPVAL1>	1 to 2	Load port number
2. <L, 2>		
1. ASCII <CPNAME2>	SLOT	Slot number parameter name
2. U2 <CPVAL2>	1 to 4	Slot number
3. <L, 2>		
1. ASCII <CPNAME3>	PNO	Equipment processing unit number parameter name
2. U2 <CPVAL3>	1 to 2	Equipment processing unit No.

Command mapping setting example

■Definitions of messages

- Define the transactions of base host command sending messages (S2F41).
- Because the number of parameters is variable, the number of parameters in the list is defined by a variable length list.
- Because the maximum number of parameters is three, three parameter lists are defined.

■Definitions of command mapping by parameters of key items

- Use the mapping setting function to specify the remote commands <RCMD> of the host command sending messages (S2F41) for the keywords of message mapping. Because receiving data of primary messages and return data of secondary messages are both subject to mapping, specify "Use the same offset for secondary messages".
- Specify the item value of <RCMD> to the parameter, and then specify the sending request trigger relays and reception notification trigger relays of messages and offsets for the command registers of message items.

■Setting example for host command sending message (S2F41) definitions

The following section shows a setting example for host command sending messages (S2F41) and an example of command mapping by remote command.

Message format	Data type	Data count	Control register
<HCS>			
<L, 2>			
1. ASCII <RCMD>	ASCII	16	R2500
2. <L, 3>	U2	1	R2509
1. <L, 2>			
1. ASCII <CPNAME1>	ASCII	16	R2510
2. U2 <CPVAL1>	U2	1	R2519
2. <L, 2>			
1. ASCII <CPNAME2>	ASCII	16	R2520
2. U2 <CPVAL2>	U2	1	R2529
3. <L, 2>			
1. ASCII <CPNAME3>	ASCII	16	R2530
2. U2 <CPVAL3>	U2	1	R2539

■Command mapping setting example

Item value of remote command (RCMD)	Primary message reception notification trigger relay	Secondary message sending request trigger the relay	Message data control register offset
LOAD	M160	M161	0
START	M162	M163	100
STOP	M164	M165	200
UNLOAD	M166	M167	300

9.9 Using the conversion table function (table conversion)

Series	SECS/GEM communication software		
	Non-GEM version	GEM version	GEM advanced version
MELSEC-Q series	<input type="radio"/>	<input type="radio"/>	<input type="radio"/>
MELSEC iQ-R series	<input type="radio"/>	<input type="radio"/>	<input type="radio"/>

Table conversion definitions are used to switch to the relevant data during message transmission between SECS message items and control registers data.

For example, an ASCII character string of the remote command of host message sending (S2F41) can be converted automatically to code easily processed by the Programmable Controller CPU.

Usage method

Add a conversion table at the "Conversion Table List" screen, and then configure a conversion table to be used at the "Item Information" screen.

■ Adding a conversion table

Configure the conversion table settings at the "Conversion Table Setting" screen. (📖 Page 124 Conversion Table Setting, Page 125 Conversion Table Setting)

Setting item	Setting content
Conversion Definition	Select "Table".
Table Name	Enter a conversion table name.
Comments	An arbitrary comment can be entered.
SECS Data Type	Specify the data type of the SECS item.
PLC Data Type	Specify the data type stored in the Programmable Controller CPU.
Data Counts	Specify the number of characters when the storage type is ASCII. For other types, set 1.
Default (SECS Data)	Specify the data to be configured to an SECS item when conversion data that matches the conversion table was not found.
Default (PLC Data)	Specify the data to be stored in the storage register of the Programmable Controller CPU when conversion data that matches the conversion table was not found.

Configure the conversion data at the "Conversion Data Setting" screen. (📖 Page 126 Conversion Data Setting)

■ Specification of table conversion

Specify a table added at the "Conversion Table List" screen by "Data Type" of the control register at the "Item Information" screen. (📖 Page 55 Item Information)



The function is also used when messages are sent

9.10 Using the conversion table function (format conversion)

Series	SECS/GEM communication software		
	Non-GEM version	GEM version	GEM advanced version
MELSEC-Q series	<input type="radio"/>	<input type="radio"/>	<input type="radio"/>
MELSEC iQ-R series	<input type="radio"/>	<input type="radio"/>	<input type="radio"/>

Format conversion definitions are used to change data stored in control registers to data that follow format definitions and send the data as an SECS message.

Usage method

Add a conversion table at the "Conversion Table List" screen, and then configure a conversion table to be used at the "Item Information" screen.

■ Adding a conversion table

Configure the format conversion settings at the "Conversion Table Setting" screen. (☞ Page 124 Conversion Table Setting, Page 125 Conversion Table Setting)

Setting item	Setting content
Conversion Definition	Select "Format".
Table Name	Enter a conversion table name.
Comments	An arbitrary comment can be entered.
SECS Data Type	Specify the data type of the SECS item. (Specify ASCII.)
PLC Data Type	Specify the data type stored in the Programmable Controller CPU.
Data Counts	Specify the number of characters when the storage type is ASCII. For other types, set 1.

Configure the formatting at the "Format conversion definition setting" screen. (☞ Page 128 Format conversion definition setting)

■ Format conversion specification

Specify a table added at the "Conversion Table List" screen by "Data Type" of the control register at the "Item Information" screen. (☞ Page 55 Item Information)

Point

The format conversion function can be checked in advance.

You can check whether the format of the specified format conversion is correct by using the data conversion simulator function at the "Format Conversion Definition Setting" screen.

Enter the data before conversion into the "Register Input Data" field, and then select the data format of this data for "Input Form". Click [Conversion] button to display the editing result.

9.11 Using the conversion table function (index conversion)

Series	SECS/GEM communication software		
	Non-GEM version	GEM version	GEM advanced version
MELSEC-Q series	<input type="radio"/>	<input type="radio"/>	<input type="radio"/>
MELSEC iQ-R series	<input type="radio"/>	<input type="radio"/>	<input type="radio"/>

Index conversion definitions are used to send floating-point number data stored as integers in control registers as a decimal-point format ASCII string by an SECS message.

Usage method

■ Adding a conversion table

Configure the index conversion settings at the "Conversion Table Setting" screen. (☞ Page 124 Conversion Table Setting, Page 125 Conversion Table Setting)

When adding a table, select "Index", and then configure "Index" and "Number of digits of integer section" to the number of decimal places and number of digits of the integer section, respectively.

■ Specifying index conversion

Specify a table added at the "Conversion Table List" screen by "Data Type" of the control register at the "Item Information" screen. (☞ Page 55 Item Information)

Point

You can convert indexes using the format conversion function as well.

The same functions as index conversion can be used by the format of format conversion.

If the example above is listed by the format of format conversion, the result is "%9.2f".

The total number of characters including the decimal point is "9", and the number of decimal places is "2".

9.12 Remote command control using the selection list function

Series	SECS/GEM communication software		
	Non-GEM version	GEM version	GEM advanced version
MELSEC-Q series	<input type="radio"/>	<input type="radio"/>	<input type="radio"/>
MELSEC iQ-R series	<input type="radio"/>	<input type="radio"/>	<input type="radio"/>

Use the selection list function to select items to be sent within the limit of the defined message structure or distinguish only items received in messages to change the item list number by the conditions.

Usage example

■ Sending only disabled parameters during host command confirmation message (S2F42) sending

Use the selection list to return only disabled parameters of the parameters (<L, 2 <CPNAME/><CPVAL/>>) received by a host command sending message (S2F41) such as with a host command confirmation message (S2F42).

Configure disabled parameters of the host command confirmation message (S2F42) to the selection list, and then configure each disabled parameter below to the selection register.

The SECS/GEM communication software sends only parameters with a value other than zero configured to the selection register during message sending.

The following table shows the configuration of the host command confirmation message (S2F42) format.

Message format	Item	Notes
<HCA>		
<L, 2>		
1. BIN <HCAACK>	Host command parameter confirmation code	0: confirmation (command was executed) 1: command cannot be confirmed 2: currently cannot be executed 3: at least one parameter is invalid 4: confirmed (the command was executed, and confirmation has been reported by an event) 5: denied (already requested) 6: this object does not exist
2. <L, 3>	Invalid parameter list	
1. <L, 2>	Invalid parameter 1	
1. ASCII <CPNAME1>	Invalid parameter name 1	
2. U2 <CPACK1>		1: parameter name does not exist 2: invalid as a parameter value specified by the parameter name 3: not a format of a parameter value specified by the parameter name >3: equipment specific definition
2. <L, 2>	Invalid parameter 2	
1. ASCII <CPNAME2>	Invalid parameter name 2	
2. U2 <CPACK2>	Invalid parameter reason 2	
3. <L, 2>	Invalid parameter 3	
1. ASCII <CPNAME3>	Invalid parameter name 3	
2. U2 <CPACK3>	Invalid parameter reason 3	

■Received parameters are distinguished upon receipt of a host command sending message (S2F41)

When there is a parameter list that differs by remote command, such as with a host command sending message (S2F41), it is possible to send and receive messages by simply defining one message that includes all parameter elements without defining messages for each remote command if the selection list function is used.

By configuring the selection register for each parameter list, and furthermore specifying a selection keyword for each parameter name of each parameter list, whether the parameter names of the received parameters match the keywords specified for each parameter list is sent back to each selection register.

When there was a match, 1 is returned. When there is no match, 0 is returned.

It is possible to conserve data storage space because message definition is concluded by a single item and the assignment is completed only by the data storage area of the necessary parameter element count.

Usage method

■Configuring selection lists

Select the "Select List" checkbox for the new list of the parameter list.

The following section is an example of the case of a host command confirmation message (S2F42).

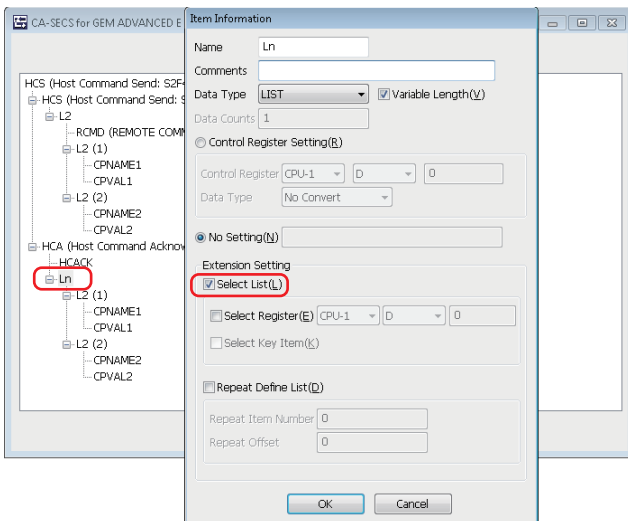

■Configuring selection registers

Configure "Select Register" for each parameter list.

In the case of a sending message, configure as shown below at the programmable controller CPU.

Sending message	In case of a register	In the case of a relay
Sending target	Not 0	ON
Not sending target	0	OFF

In the case of a reception message, the SECS/GEM communication software configures in the following manner.

Reception message	In case of a register	In the case of a relay
Received	1	ON
Not received	0	OFF

The following section is an example of the case of a host command confirmation message (S2F42).

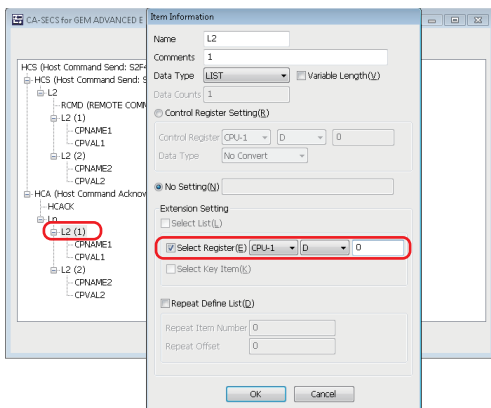

■Configuring selection key items

Configure the fixed value and selection key item for the parameter name.

If a parameter that matches this fixed value is received, 1 is stored in the selection register of the new parameter list.

It is necessary to configure the selection list and selection register in advance to use the selection key item.

The following section is an example of the case of a host command sending message (S2F41).

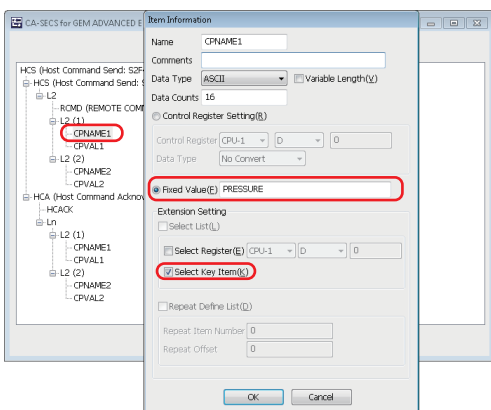

Ladder program processing can be reduced by using both the mapping and selection list / selection register function.

9.13 Synchronizing the clocks of the equipment and host

Series	SECS/GEM communication software		
	Non-GEM version	GEM version	GEM advanced version
MELSEC-Q series	<input type="radio"/>	<input type="radio"/>	<input type="radio"/>
MELSEC iQ-R series	<input type="radio"/>	<input type="radio"/>	<input type="radio"/>

Three time synchronization scenarios can be used through settings.

Time synchronization scenarios

■Time request from equipment to host

Scenario	Function
S2F17 (Date and time request)	A date and time request message (S2F17) is sent from the equipment, and the host time is received by a date and time data message (S2F18) from the host. The time received from the host can be stored in the register.

■Time request from host to equipment

Scenario	Function
S2F17 (Date and time request)	A date and time request message (S2F17) is received from the host, and the equipment time is sent by a date and time data message (S2F18) from the equipment. The return of the time to the host can be reported by the time synchronization notification relay.

■Time set instruction from host to equipment

Scenario	Function
S2F31 (Date and time set request)	The host time is received by a date and time set request message (S2F31) from the host, and the equipment sends a date and time set confirmation message (S2F32). The synchronization of the time by the instruction from the host can be reported by the time synchronization notification relay. The time received from the host can be stored in the register.

Usage method

■In the case of the MELSEC-Q series SECS/GEM communication software pre-installed model module

The clock of the C Controller module can be changed to the time of the received item <TIME>. However, because the time zone of CPU No. 1 is followed for a multi-CPU system, change the time of CPU No. 1 by the programmable controller CPU.

The setting to change the clock of the C Controller module to the time of <TIME> is configured at [Control 2] of the "Option setting" screen. (📖 Page 77 Control 2)

If the "Change C Controller's Clock Upon S2F31/S2F18 Receipt" checkbox is selected, the clock of the C Controller module is changed automatically to the date and time of the item <TIME> received by an S2F18 (date and time data) or S2F31 (date and time setting request) message from the host.

■In the case of the MELSEC iQ-R series SECS/GEM communication software pre-installed model module

The clock of the C intelligent function module cannot be changed to the time received by item <TIME>. Because the time zone of the CPU module (CPU No.1 for a multi-CPU system) is followed, change the time of the CPU module by the programmable controller CPU.



If a date and time request message (S2F17) is received from the host, the SECS/GEM communication software returns the date and time of the SECS/GEM communication software pre-installed model module automatically.

9.14 Transitioning to a communication state

Series	SECS/GEM communication software		
	Non-GEM version	GEM version	GEM advanced version
MELSEC-Q series	—	○	○
MELSEC iQ-R series	—	○	○

The communication state is managed according to the communication model state of GEM. The following three control methods can be selected by SECS/GEM communication software.

Control method	Function
AUTO	The SECS/GEM communication software controls the communication state automatically according to the communication state model of GEM.
SEMI-AUTO	The SECS/GEM communication software controls the communication state automatically only while the communication establishment request relay is ON.
MANUAL	A communication establishment request message (S1F13) is sent when triggered by the communications establishment request relay switching ON. If a communication establishment request confirmation message (S1F14) is received, the state transitions to a communication establishment state. The SECS/GEM communication software switches OFF the communications establishment request relay.

Usage method

■ Switching communication on and off

Operator actions switch communication on and off.

Configure the setting from the screen displayed by the [State Change] tab of the "Communication State Settings" screen.

( Page 165 State Change)

Select the "ENABLED/DISABLED" checkbox, and then configure the communication on/off switching relay.

Communication is on or off when the relay is on or off, respectively.

■ Communication state control settings

Configure the setting at the [Control] tab of the "Communication state settings" screen. ( Page 165 Control)

Select the control method. With a setting other than AUTO, configure the communication establishment request relay.

Point

The communication state can be saved in a state variable in the settings at the [State Notification] tab of the "Communication State Settings" screen.

9.15 Transitioning to a control state

Series	SECS/GEM communication software		
	Non-GEM version	GEM version	GEM advanced version
MELSEC-Q series	—	○	○
MELSEC iQ-R series	—	○	○

The control state is managed according to the control model state of GEM.

The following two control methods can be selected by SECS/GEM communication software.

Control method	Function
AUTO	The SECS/GEM communication software controls the control state automatically according to the control state model of GEM.
MANUAL	An online confirmation request message (S1F1) is sent when triggered by the online request relay switching ON. If an online data message (S1F2) is received, the state transitions to an online state. The SECS/GEM communication software switches OFF the online request relay.

Usage method

■Control state switching by the operator

Configure the setting at the [State Change] tab of the "Control State Settings" screen. (📖 Page 169 State Change)

Select the checkbox of the switching functions to be used, and then configure the switching request trigger relays.

Operator actions control the switch from online to offline, and online local and online remote.

■Configuring the control state switching control

Configure the setting at the [Control] tab of the "Control State Settings" screen. (📖 Page 169 Control)

Select the control method. When MANUAL is selected, configure the On-Line Request trigger relay.

Point

The control state can be set in a state variable in the settings at the [State Notification] tab of the "Control State Settings" screen.

If the automatic event sending function of GEM is used, the host can be notified of the control state via an event when transitioning the control communication state.

9.16 Configuring collected events

Series	SECS/GEM communication software		
	Non-GEM version	GEM version	GEM advanced version
MELSEC-Q series	—	○	○
MELSEC iQ-R series	—	○	○

Events are made up of report lists, and reports are made up of variable lists.

Both are configured by the setting tool.

Events and reports are identified by event IDs and report IDs.

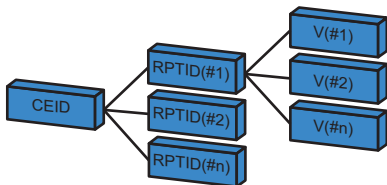

CEID: Event ID
 RPTID: Report ID
 V: Variables

There are three variable (V) types: state variables (SV), dispersal variables (DV), and equipment constants (ECV), which are configured by the setting tool.

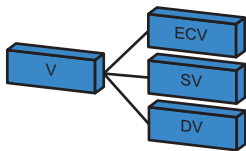

Usage method

■Configuring variables

Variables disclosed by the equipment are configured by the setting tool.

Double-click a row inserted by [Insert] of the shortcut menu of the "Variable List" screen to display the "Variable Definition" screen, and then configure the settings. (☞ Page 192 Variable list, Page 194 Variable definition)

■Configuring reports

Double-click a row inserted by [Insert] of the shortcut menu of the "Report List" screen to display the "Report Definition" screen, and then configure the settings. (☞ Page 204 Report list, Page 205 Report definition)

To create a report, click [Create Report] button in the "Report Definition" screen, and then create the report at the "Create Report" screen. (☞ Page 205 Create Report)

For variables, select the variable to be added from the "Variables" pull-down list of the "Create Report" screen, and then click the [Add] button.

■Configuring events

Double-click a row inserted by [Insert] of the shortcut menu of the "Event List" screen to display the "Event Definition" screen, and then configure the settings. (☞ Page 207 Event list, Page 208 Event definition)

To create an event, click [Create Event] button in the "Event Definition" screen, and then create the event at the "Create Event" screen. (☞ Page 209 Create Event)

For the report, select the report to be added from the [Reports] pull-down list of the "Create Event" screen, and then click the [Add] button.

■Event notification method

Automatic and manual notifications can be selected at the "Event Definition" settings screen.

- Automatic notification: If "Automatic Event Transmission" is selected, and a GEM automatic notification time is selected via the pull-down list just below, the selected event is reported to the host at the specified timing.
- Manual notification (sending via a trigger instruction from a Programmable Controller CPU): If "Sequencer Transmission Request" is selected, and the transmission request trigger is configured, the host is notified of the corresponding event when the transmission request trigger is on. The trigger is switched off after the SECS/GEM communication software reports to the host. (When a handshake has been selected)

Point

The SECS/GEM communication software processes the following event functions automatically.

- A report or event can be also generated dynamically by an instruction from the host.
 - The event report or individual report requested by the host is sent back automatically.
-

9.17 Using the process program

Series	SECS/GEM communication software		
	Non-GEM version	GEM version	GEM advanced version
MELSEC-Q series	—	—	○
MELSEC iQ-R series	—	—	○

The GEM advanced version of the SECS/GEM communication software provides functions that assist the management of the process program directory (PPID list).

The three helper functions are as follows.

- Response to process program deletion command (S7F17)^{*1}
- Automatic response to current EPPD request (S7F19)
- Sending of process program change event (S6F11) from equipment ^{*1}

^{*1} Manage the process programs by the equipment application.

Example of management by the host

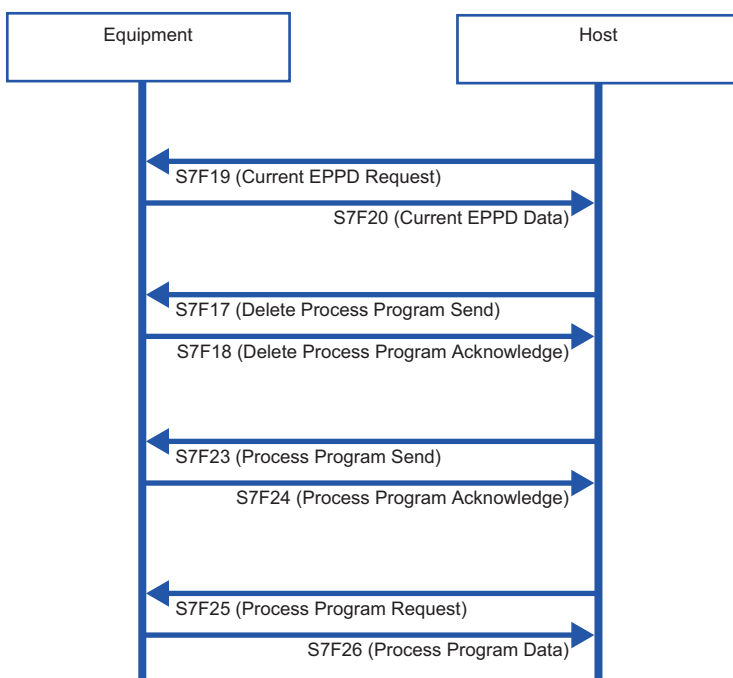

Host → Equipment	Equipment action
S7F19 (Process program directory request)	The process program directory is sent back to the host. The following information is returned. • List of the process program names (PPID) retained by the equipment
S7F17 (Process program deletion instruction)	Deletes the process program requested (PPID).
S7F23 (Process program sending)	Reports the received process program to the equipment. ^{*1}
S7F25 (Process program request)	The process program requested (PPID) is sent back to the host. ^{*1}

^{*1} Define the transaction, and process via equipment application.

Example of management by the equipment

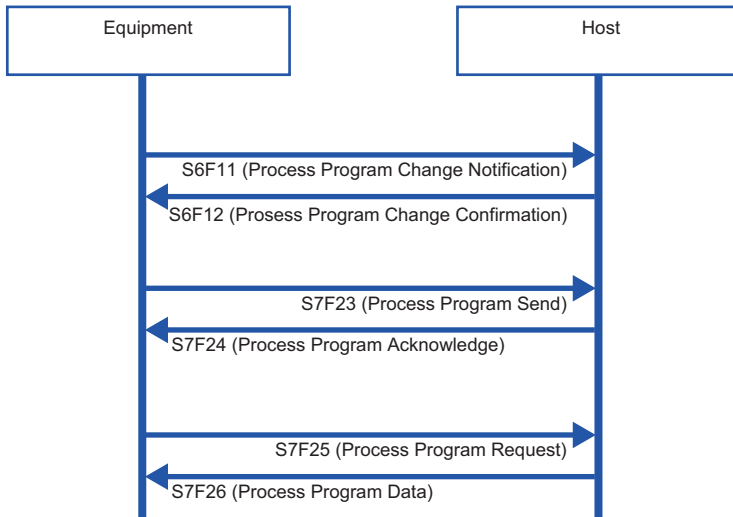

Equipment operation	Equipment → Host	Description
Change of process program	S6F11 (Event report: Change of process program)	When a process program is created, modified, or deleted at the equipment, the host is notified of the change of the process program via an event. The notification contains the following information. <ul style="list-style-type: none"> • Process program name (PPID) • Changed state (creation/modification/deletion)
Upload of process program to host	S7F23 (Process program sending)	The process program retained at the equipment is uploaded to the host.*1
Download of process program from host	S7F25 (Process program request)	The process program is obtained from the host.*1

*1 Define the transaction, and process via equipment application.

Usage method

Directory settings

The directory of the process program (EPPD) is configured by the setting tool.

Configure the settings at the [Directory] tab of the "Process program settings" screen. (📖 Page 185 Directory)

Configure the number of directory entries, and the start register for the directory entry and directory information.

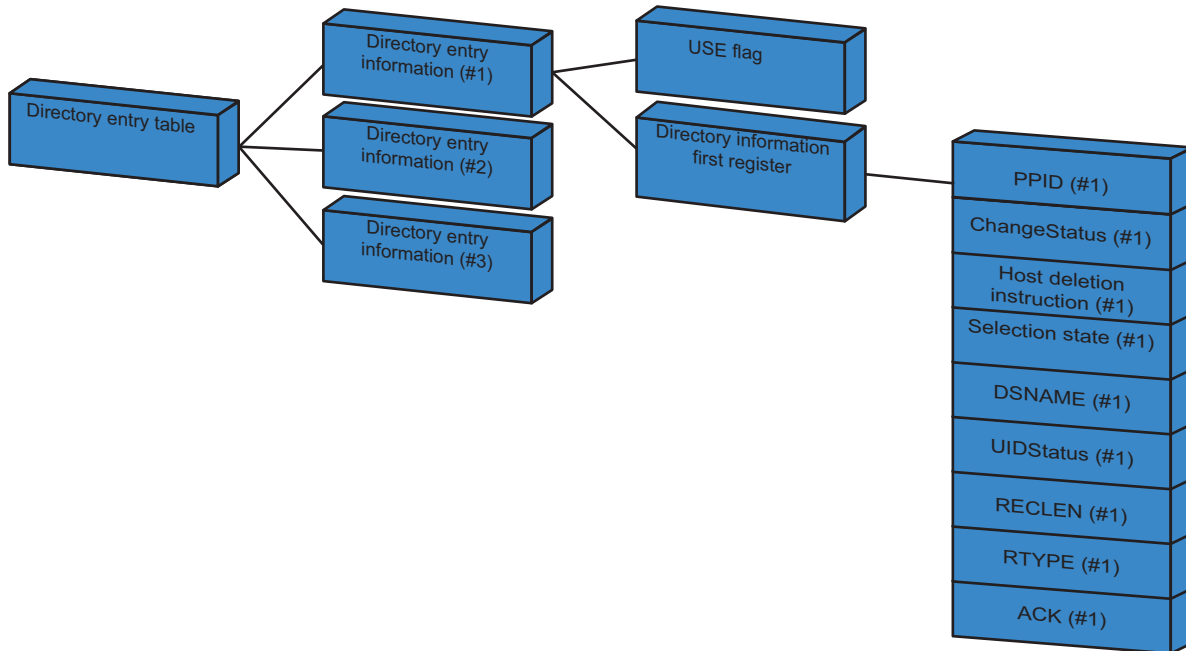

■Directory entry information

For the directory entry (start), configure the first register of the directory entry information table.

The directory entry information table holds the entry (first register) of each directory information item and defines consecutively the number of directory entries set by "No. Of Directory Entries".

The following section shows the structure of the directory entry information.

Item	Word count	Description
USE flag	1	0: not used 1: used
Directory information first register	1	First register of directory information linked to the corresponding entry

The following table shows a directory entry table with three directory entries.

The first register of the directory entry table is configured in "Directory Entry (Start)".

Offset	Directory entry table		Description
+0W	Directory entry information 1	USE flag	1 (use)
		Directory information first register	Directory information 1 first register
+2W	Directory entry information 2	USE flag	1 (use)
		Directory information first register	Directory information 2 first register
+4W	Directory entry information 3	USE flag	1 (use)
		Directory information first register	Directory information 3 first register

■ Structure of directory information

The following section shows the structure of each directory information item.

Directory information of the amount specified by the number of directory entries is assigned.

The entry of each directory information item is linked and defined by each directory entry of the directory entry information table.

The following directory information items must be initialized when the equipment is started.

The current process program ID retained by the equipment is set to PPID.

Item	Word count	Description
PPID	41	Process program ID
ChangeStatus	1	0: no change 1: creation 2: modification 3: deletion
Host deletion instruction	1	0: no instruction 1: instruction
Selection state	1	0: no selection 1: selected
DSNAME	17	Data set name ^{*1}
UIDStatus	1	0: none 1: upload 2: download ^{*1}
RECLEN	1	Directory maximum record length ^{*1}
RTYPE	1	0: stream 1 = discrete ^{*1}
ACK	1	ACK during upload/download ^{*1}

*1 Items reserved for future functions. Initialize using "0" at equipment startup processing.

Directory request from host

When a current EPPD request message (S7F19) was received from the host, the SECS/GEM communication software creates a current EPPD data message (S7F20) from the current directory information content, and then sends it to the host automatically.

Directory deletion request from host

Configure the handshake to delete the process program of the PPID specified by the host at the [Change notification] tab of the "Process Program Settings" screen. (🔍 Page 186 Change notification)

Select the "Enable S7F17 Scenario" checkbox, and then configure the notification destination trigger and storage register.

■Handshake methods

When a process program deletion instruction message (S7F17) has been received from the host, the SECS/GEM communication software configures [Deletion instruction] for the directory information of the corresponding process program, and then switches ON the Process Program Deletion Notification.

When this relay is ON, the programmable controller CPU deletes the process program it was instructed to delete. The result of the deletion is set to the register to save process program deletion results. Next, the process program deletion notification trigger is switched OFF, and the process program deletion completion notification trigger is switched ON.

The SECS/GEM communication software receives that the process program deletion completion notification is ON, sends a process program deletion confirmation message (S7F18) message to the host, and then switches OFF the process program deletion completion notification.

Notification of process program change from the equipment

Configure the notification to the host that the process program was changed at the equipment at the screen of the [Change Notification] tab of the "Process Program Settings" screen. (🔍 Page 186 Change notification)

Specify the notification destination using "Process Program Change".

■Handshake methods

When the process program has been changed at the equipment, the change status is configured for [Change Status] of the corresponding directory information, and the process program change trigger relay is switched ON.

The SECS/GEM communication software sends a process program change notification (S6F11) to the host, and then switches OFF the process program change trigger relay.

Notification of process program selection at the equipment

Configure the notification to the host that the process program was selected at the equipment at the screen of the [Change Notification] tab of the "Process Program Settings" screen. (🔍 Page 186 Change notification)

Specify the notification destination using "Process Program Select".

■Handshake methods

When a process program has been selected at the equipment, the selection status is set for [Selection State] of the corresponding directory information, and the process program select trigger relay is switched ON.

The SECS/GEM communication software sends the selection of a process program (S6F11) to the host, and then switches OFF the process program select trigger relay.

Point

When the automatic process program processing function of the SECS/GEM communication software is not used, select the [Exclusion] tab of the "Process program settings" screen, and then clear the [On] checkbox of each scenario.

10 TROUBLESHOOTING





This section explains the troubleshooting of a SECS/GEM communication software pre-installed model module.

10.1 Troubleshooting by Symptom

This section shows the troubleshooting by phenomenon for a SECS/GEM communication software pre-installed model module.

Symptom	Check item	Corrective action
A multi-CPU error occurred with a programmable controller CPU and MELSEC-Q series SECS/GEM communication software pre-installed model module	Do the multi-CPU settings of the programmable controller CPU and MELSEC-Q series SECS/GEM communication software pre-installed model module match?	During use with a multi-CPU configuration, the settings of the parameters of the CPU must match. Review the parameter settings. For the parameter setting method, see the manual of the programmable controller CPU to be used.
A ladder program cannot be written to the programmable controller CPU	There is a problem with the GX Works2 or GX Works3 settings	When the GX Works2 or GX Works3 cannot connect with the Programmable Controller CPU, check for problems in the settings of the GX Works2 or GX Works3 . For the parameter setting method, see the manual of the programmable controller CPU to be used.
	There is an error during Ethernet diagnosis.	When the GX Works2 or GX Works3 and Programmable Controller CPU are connected via Ethernet, check the details of the Ethernet diagnosis error, and then remove the cause of the error.
The user login settings of the C Controller module or C intelligent function module are unknown	The C Controller module or C intelligent function module has been initialized.	The following table shows the default values when the C Controller module or C intelligent function module has been initialized. IP address (CH1): 192.168.3.3 Username: "target" Password: "password" For the initialization method, see the manual of the C Controller module or C intelligent function module. The pre-installed SECS/GEM communication software license is erased when the C Controller module or C intelligent function module has been initialized.
C language settings cannot be written to the C Controller module	There is a problem with the settings of Setting/monitoring tools for the C Controller module.	When Setting/monitoring tools for the C Controller module cannot connect with the Programmable Controller CPU, check for problems in the settings of Setting/monitoring tools for the C Controller module. For the configuration method, see the manual of Setting/monitoring tools for the C Controller module.
The SECS/GEM communication software cannot be installed on the personal computer	The user currently logged in does not have administrative rights for the personal computer	A user with administrative rights must login and install the software.
The project file of the SECS/GEM communication software cannot be opened	Was the PC restarted after installing the setting tool?	Restart the PC after installing the setting tool.

Symptom	Check item	Corrective action
The SECS/GEM communication software pre-installed model module cannot be updated	Is there a response from the SECS/GEM communication software pre-installed model module with a ping command?	<p>Check for problems with the LAN cable connection.</p> <p>From the command prompt of the PC, etc., issue a ping command.</p> <p>Specification method: ping (IP address)</p> <p>Example: ping 192.168.3.3</p> <p>If there is no response, the IP address of the SECS/GEM communication software pre-installed model module may be different. Check the IP address using GX Works3 or the Setting/monitoring tools for the C Controller module.</p> <p>Connection is not possible when the IP address settings of the computer differ with the subnet mask of the SECS/GEM communication software pre-installed model module. Configure the correct IP address.</p>
	The user and password entered by using [Setting] and then [Update C language controller] / [Update C intelligent function module] is incorrect	<p>The entry may be incorrect if the caps lock key is on.</p> <p>Switch off the caps lock key, and then make sure there are no mistakes in the entered information.</p>
	The program is blocked by the firewall settings	<p>If ["CA-SECS (product name)"] is blocked in the firewall settings, communication is not possible.</p> <p>Check the firewall settings, and then changes the setting to allow ["CA-SECS (product name)"].</p>
	A proxy server is being used	<p>If a proxy server is being used, the IP address of the SECS/GEM communication software pre-installed model module must be configured so that a proxy server is not used.</p>
	Is the network device connected to the SECS/GEM communication software pre-installed model module enabled?	<p>In the network connection settings, enable the network device connected to the SECS/GEM communication software pre-installed model module.</p> <p>Furthermore, an update may not be possible if other network devices are enabled. In this case, check by disabling other network devices temporarily.</p>
	[Work Offline] is configured in Internet Explorer	<p>When Internet Explorer 10 or earlier is being used during offline work, click the [File] menu, and then clear the checkbox beside [Work offline].</p>
	Is antivirus software installed?	<p>It may not be possible to update the SECS/GEM communication software pre-installed model module due to the antivirus software.</p> <p>Switch off the antivirus software temporarily, and then see if the problem is resolved.</p>

Symptom	Check item	Corrective action
The SECS/GEM communication software transferred to the SECS/GEM communication software pre-installed model module does not start	The CIM control READY relay is not on	If the CIM Control READY relay is on, SECS/GEM communication software is running. For the settings of the CIM control READY relay, see the following reference.  Page 82 CA Status
	Is there CA-SECS event information in the event history of the SECS/GEM communication software pre-installed model module?	If the SECS/GEM communication software starts, version information and license registration information appear in the event history of the SECS/GEM communication software pre-installed model module. Check if there is event information described in the following: <ul style="list-style-type: none"> When using a non-GEM version of MELSEC-Q series SECS/GEM communication software pre-installed model module, check if there is event information with "CAS" displayed for "Source." When using a GEM or GEM advanced version of MELSEC-Q series SECS/GEM communication software pre-installed model module, check if there is event information with "CASECS" displayed for "Source." When using a MELSEC iQ-R series SECS/GEM communication software pre-installed model module, check if there is event information that "RD55UP06-V" is displayed in "Source" and that starts with 'detail information: [CAS]' in "Detailed event log information."
	Is the SECS/GEM communication software installed on the SECS/GEM communication software pre-installed model module?	Make sure that the SECS/GEM communication software is installed at the transfer destination of the SECS/GEM communication software pre-installed model module. Transfer destination: /CF, /SD, or /ROM Transfer file name: CIMOP.OUT or CIMOP_GEM.OUT For the method to install the SECS/GEM communication software on the SECS/GEM communication software pre-installed model module, see the following reference.  Page 112 Updating the SECS/GEM communication software pre-installed model module
	Is the Mode switch of the MELSEC-Q series SECS/GEM communication software pre-installed model module set to RUN?	If the Mode switch of the MELSEC-Q series SECS/GEM communication software pre-installed model module set to "STOP", device control to the programmable controller CPU is not possible. When SECS/GEM communication is used, always set the switch to "RUN".
	Are there any other applications on the SECS/GEM communication software pre-installed model module?	If other applications are running, SECS/GEM communication software may be affected. Do not run any other applications.
	Is a CF card installed in the MELSEC-Q series SECS/GEM communication software pre-installed model module?	SECS/GEM communication software requires a CF card. For CF cards with confirmed operation, see the following reference.  Technical bulletin No. FA-D-0023 For the specifications of CF cards, see the website of the product.
	Is an SD memory card installed in the MELSEC iQ-R series SECS/GEM communication software pre-installed model module?	SECS/GEM communication software requires a SD memory card. For SD memory cards with confirmed operation, see the following reference.  MELSEC iQ-R C Intelligent Function Module User's Manual (Startup)  Technical bulletin No. FA-D-0023 For the specifications of SD cards, see the website of the product.
	There is incorrect device assignment settings in SECS/GEM communication software	Define all device assignment settings for devices used by SECS/GEM communication software. If devices not defined by the device assignment settings are configured by various functions, access is not authorized. When the MELSEC-Q series SECS/GEM communication software pre-installed model module will be used, the multi-CPU settings of the programmable controller CPU unit and MELSEC-Q series SECS/GEM communication software pre-installed model module must also be defined in the range settings of shared memory. For the multi-CPU settings, see the manual of each unit.

Symptom	Check item	Corrective action
SECS communication via HSMS is not possible between SECS/GEM communication software and host	SECS/GEM communication software is not started	Refer to "The SECS/GEM communication software transferred to the SECS/GEM communication software pre-installed model module does not start" in "Troubleshooting", and then check that the SECS/GEM communication software has started.
	The line disconnection relay is off	After starting, SECS/GEM communication software attempts to connect with the correspondence destination automatically. If the HSMS communication state is SELECTED, the line disconnection relay is switched off, so check whether this relay is off. For the settings of the line disconnection relay, see the following reference.  Page 82 CA Status
	Communication settings with the correspondence destination are incorrect	When SECS/GEM communication software is running, and the line disconnection relay is on, the communication setting content may be incorrect. Check whether the following items have matching settings at the equipment and host. (Example: is the connection mode setting Active on one side and Passive on the other?) <ul style="list-style-type: none"> • Connection mode: Active/Passive • IP address: Local/Remote • IP port: Local/Remote
	The communication port of the correspondence destination is not open	Using the netstat command, check whether the port of the correspondence destination is open.

Symptom	Check item	Corrective action
An SECS message is not sent even when the sending request trigger is ON	The communication-established relay is not on	SECS/GEM communication software manages the communication establishment state, and establishing an S1F13/14 transaction results in a communication establishment state, and the communication-established relay switches on. When communication is not established, messages other than S1F13/14 cannot be sent. For the settings of the Communication established relay, see the following reference. ☞ Page 82 CA Status
	The online relay is not on	SECS/GEM communication software manages the online state, and establishing an S1F1/2 transaction establishes an online state, and the online relay is switched on. During an online state, messages other than S1Fx cannot be sent. For the settings of the online relay, see the following reference. ☞ Page 82 CA Status
	The programmable controller CPU is set to "STOP", and the sending request trigger is set to ON manually	If the Programmable Controller CPU is set to "STOP", and messages can be sent, check the program of the Programmable Controller CPU. If the messages cannot be sent even when the programmable controller CPU is set to "STOP", check the above check items: "The communication-established relay is not on" and "The online relay is not on".
	There is no spooling state	A spooling state results if there is an attempt to send a message subject to spooling in an offline state. In a spooling state, the following messages subject to spooling are spooled and not sent. The spooling state is not cleared until a S6F23/24 transaction is established from the correspondence destination. For the settings of the spooling state, see the following reference. ☞ Page 106 Spooling function (non-GEM version) ☞ Page 180 Spool Function (GEM / GEM advanced version)
	There is incorrect device assignment settings in SECS/GEM communication software	Define all device assignment settings for devices used by SECS/GEM communication software. If devices not defined by the device assignment settings are configured by various functions, access is not authorized. When the MELSEC-Q series SECS/GEM communication software pre-installed model module will be used, the multi-CPU settings of the programmable controller CPU unit and MELSEC-Q series SECS/GEM communication software pre-installed model module must also be defined in the range settings of shared memory. For the multi-CPU settings, see the manual of each unit.
	Is a device of the MELSEC-Q series SECS/GEM communication software pre-installed model module within the shared memory being used for a trigger?	When a device within the shared memory range is used as a trigger relay, configure a device of the Programmable Controller CPU. When a device of the MELSEC-Q series SECS/GEM communication software pre-installed model module has been configured, access from the programmable controller CPU is not possible, and it cannot be used as a trigger relay.
	"Shared Memory Synch Waiting Timer" setting is inappropriate	SECS/GEM communication software performs a synchronization check to confirm the handshake with the Programmable Controller CPU. By default, the "Shared Memory Synch. Waiting Timer" is configured to 10 ms. Adjust the shared memory synch. waiting timer according to the scan time of the programmable controller CPU. For the settings of the Shared Memory Synch. Waiting Timer, see the following reference. ☞ Page 77 Control 2

Symptom	Check item	Corrective action
The reception notification trigger does not switch ON even when receiving an SECS message	A S9 related error has occurred	Check whether a S9 related error has occurred in the SECS communication log. If an error has occurred, remove the cause of the error. For the log reference method, see the following reference. ☞ Page 134 Log Output
	The transaction created by the settings tool does not match the list structure of the receiving message	When the message received from the correspondence destination is different from the list structure, item type, and data length of the transaction created by the setting tool, a S9 related error message is sent, and the corresponding reception notification trigger is not switched ON. Review the structure of the transaction. For the transaction creation method, see the following reference. ☞ Page 46 Transaction definition
	Is the Mode switch of the MELSEC-Q series SECS/GEM communication software pre-installed model module set to RUN?	If the Mode switch of the MELSEC-Q series SECS/GEM communication software pre-installed model module set to "STOP", device control to the programmable controller CPU is not possible. When SECS/GEM communication is used, always set the switch to "RUN".
	There is incorrect device assignment settings in SECS/GEM communication software	Define all device assignment settings for devices used by SECS/GEM communication software. If devices not defined by the device assignment settings are configured by various functions, access is not authorized. When the MELSEC-Q series SECS/GEM communication software pre-installed model module will be used, the multi-CPU settings of the programmable controller CPU unit and MELSEC-Q series SECS/GEM communication software pre-installed model module must also be defined in the range settings of shared memory. For the multi-CPU settings, see the manual of each unit.
Communication erroneously stops during SECS communication	A line disconnection request has been received from the Programmable Controller CPU	Check the PLC log and check whether a line disconnection request has been received. If an unintentional request has been received, remove the cause.
	A line disconnection request has been received from the correspondence destination	Check the SECS log, and then check whether a line disconnection request has been received. If an unintentional request has been received, remove the cause.
	Check for physical problems with the LAN cable.	Check whether the LAN cable has been unplugged or disconnected.
	IP addresses are conflicting	If the IP address of the C Controller module is conflicting, the line may be disconnected. If the IP address was conflicting, remove the cause.
	CIM Control READY is off	If the CIM Control READY is set to off in the program of the Programmable Controller CPU, SECS/GEM communication software no longer operates. Do not operate by the program of the Programmable Controller CPU.
The sending and receiving of SECS messages are delayed	The cache settings of the referent device are not set	When a device defined for the I/O assignment in the device assignment settings is configured as the data referent of the transaction item, setting the cache settings of the corresponding transaction can improve the speed performance. For the transaction cache settings, see the following reference. ☞ Page 50 Cache settings
	The trigger hold time of the sending request trigger is inappropriate	The detection time of the sending request trigger can be adjusted by the settings of the trigger hold time. Configure an appropriate time. For the settings of the trigger hold time, see the following reference. ☞ Page 52 Message Information
An SECS message is sent twice erroneously by a single sending request	"Shared Memory Synch Waiting Timer" setting is inappropriate	SECS/GEM communication software performs a synchronization check to confirm the handshake with the Programmable Controller CPU. By default, the "Shared Memory Synch. Waiting Timer" is configured to 10 ms. Adjust the shared memory synch. waiting timer according to the scan time of the programmable controller CPU. For the settings of the Shared Memory Synch. Waiting Timer, see the following reference. ☞ Page 77 Control 2

Symptom	Check item	Corrective action
The log cannot be accessed by the settings tool of the SECS/GEM communication software	The log output settings are not configured	Browse to [Log] ⇒ [Log Output Setting], and then check the settings to output the log. For log output settings, see the following reference. ☞ Page 134 Log Output
	The log output trigger is not on before SECS/GEM communication software starts	When log aggregation is to be controlled by the log output trigger, use the CIM Control READY relay, make sure that SECS/GEM communication software has started, and then switch on the log output trigger. For log output trigger settings, see the following reference. ☞ Page 134 Log Output
	The mode switch of the C Controller module is "STOP"	If the mode switch of the C Controller module is "STOP", SECS/GEM communication software cannot output the log. When SECS/GEM communication is used, always set the switch to "RUN".
	The connection destination settings are incorrect	Make sure that the entries of the IP address, username, and password of the connection destination are correct.
	The C Controller module or C intelligent function module time is offset	The time information of the log data is dependent on the time of the C Controller module or C intelligent function module. Check the time of the C Controller module or C intelligent function module, and then specify the referenced time. For the method to access the log using the settings tool, see the following reference. ☞ Page 143 Log View
	The settings tool is not installed on the personal computer	When settings are configured at [Log] ⇒ [Log Output Setting] ⇒ [Device Display Setting] to display the log on the equipment display, a text-format log file (*.log) is output under the "Log output destination/GOT/" folder. The text-format log file can be acquired and accessed via FTP. Furthermore, it is possible to use the display register to access the content of the text-format log file at the equipment display, etc. For details on the text-format log file, see the following reference. ☞ Page 149 View the Log on Display Device (GOT)
An SECS error message is generated	The online relay is not on	SECS/GEM communication software manages the online state, and establishing an S1F1/2 transaction establishes an online state, and the online relay is switched on. During an online state, messages other than S1Fx cannot be sent. For the settings of the online relay, see the following reference. ☞ Page 82 CA Status
A 'Memory insufficient.' message is displayed by SECS/GEM communication software setting tool	SECS/GEM communication software setting tool is being used when the personal computer is under a high load	Close unnecessary applications to reduce the load of the personal computer before using SECS/GEM communication software setting tool.
	SECS/GEM communication software is consuming a large amount of virtual memory	Check the device assignment settings. Do not configure devices that will not or cannot be used. Furthermore, when the number of bit devices (word count) is configured, make sure the entered value is the word count. For details on settings of device assignment, see the following reference. ☞ Page 65 Device Assignment

APPENDIX

Appendix 1 Input/output signals

This section explains the input/output signals of a MELSEC iQ-R series SECS/GEM communication software pre-installed model module.

Only specifications that differ with the C intelligent function module are explained. For common specifications, see the following reference.

📖 MELSEC iQ-R C Intelligent Function Module User Manual (Application Edition)

Initialization setting of host station device

input signal

Device number	Description
X10	CIM Control READY
X11	Disconnected
X12	Communication Established
X13	Online
X14	Not set
X15	Not set
X16	Not set
X17	Not set
X18	Not set
X19	Not set
X1A	Not set
X1B	Not set
X1C	Not set
X1D	Not set
X1E	Not set
X1F	SD error

Output signal

Device number	Description
Y10	Not set
Y11	Line Disconnection
Y12	Line Connection
Y13	Online Start
Y14	Offline
Y15	Not set
Y16	Not set
Y17	Not set
Y18	Not set
Y19	Not set
Y1A	Not set
Y1B	Not set
Y1C	Not set
Y1D	Not set
Y1E	Not set
Y1F	Not set

Appendix 2 Data type conversion

This section explains data type conversion.

Conversion from the SECS/GEM communication software to a programmable controller CPU

Binary → ASCII

Source	Dest																		
<ul style="list-style-type: none"> I1, I2, U1, or U2 <div style="display: flex; justify-content: space-around; align-items: center;"> <div style="border: 1px solid black; padding: 5px; margin: 5px;">I1 or U1</div> <div style="border: 1px solid black; padding: 5px; margin: 5px;">I2 or U2</div> </div>	<ul style="list-style-type: none"> ASCII <table border="1" style="width: 100%;"> <tr> <td>D</td> <td>Ten thousands</td> <td>Sign</td> </tr> <tr> <td>D+1</td> <td>Hundred</td> <td>Thousand</td> </tr> <tr> <td>D+2</td> <td>One</td> <td>Ten</td> </tr> <tr> <td>D+3</td> <td colspan="2">0</td> </tr> </table>	D	Ten thousands	Sign	D+1	Hundred	Thousand	D+2	One	Ten	D+3	0							
D	Ten thousands	Sign																	
D+1	Hundred	Thousand																	
D+2	One	Ten																	
D+3	0																		
<ul style="list-style-type: none"> I4 or U4 <div style="border: 1px solid black; padding: 5px; margin: 5px; width: 100%;">I4 or U4</div>	<ul style="list-style-type: none"> ASCII <table border="1" style="width: 100%;"> <tr> <td>D</td> <td>Billion</td> <td>Sign</td> </tr> <tr> <td>D+1</td> <td>Ten millions</td> <td>Hundred millions</td> </tr> <tr> <td>D+2</td> <td>Hundred thousands</td> <td>Million</td> </tr> <tr> <td>D+3</td> <td>Thousand</td> <td>Ten thousands</td> </tr> <tr> <td>D+4</td> <td>Ten</td> <td>Hundred</td> </tr> <tr> <td>D+5</td> <td colspan="2">0</td> </tr> </table>	D	Billion	Sign	D+1	Ten millions	Hundred millions	D+2	Hundred thousands	Million	D+3	Thousand	Ten thousands	D+4	Ten	Hundred	D+5	0	
D	Billion	Sign																	
D+1	Ten millions	Hundred millions																	
D+2	Hundred thousands	Million																	
D+3	Thousand	Ten thousands																	
D+4	Ten	Hundred																	
D+5	0																		

ASCII → Binary

Source	Dest														
<ul style="list-style-type: none"> ASCII <table style="width: 100%;"> <tr> <td style="width: 10%; text-align: center;">0</td> <td style="border: 1px solid black; padding: 2px;">Sign</td> </tr> <tr> <td style="text-align: center;">1</td> <td style="border: 1px solid black; padding: 2px;">Ten thousands</td> </tr> <tr> <td style="text-align: center;">2</td> <td style="border: 1px solid black; padding: 2px;">Thousand</td> </tr> <tr> <td style="text-align: center;">3</td> <td style="border: 1px solid black; padding: 2px;">Hundred</td> </tr> <tr> <td style="text-align: center;">4</td> <td style="border: 1px solid black; padding: 2px;">Ten</td> </tr> <tr> <td style="text-align: center;">5</td> <td style="border: 1px solid black; padding: 2px;">One</td> </tr> <tr> <td style="text-align: center;">6</td> <td style="border: 1px solid black; padding: 2px;">0</td> </tr> </table> <p>From the sign, specify a numerical character string to the stopper. Signs can be omitted. Treated as + when signs were omitted.</p>	0	Sign	1	Ten thousands	2	Thousand	3	Hundred	4	Ten	5	One	6	0	<ul style="list-style-type: none"> I1, I2, U1, or U2 <div style="border: 1px solid black; padding: 5px; margin: 5px; width: 100%;">I1, I2, U1, or U2</div>
0	Sign														
1	Ten thousands														
2	Thousand														
3	Hundred														
4	Ten														
5	One														
6	0														



Source		Dest
• ASCII		• I4 or U4
0	Sign	D
1	Billion	D+1
2	Hundred millions	
3	Ten millions	
4	Million	
5	Hundred thousands	
6	Ten thousands	
7	Thousand	
8	Hundred	
9	Ten	
10	One	
11	0	

From the sign, specify a numerical character string to the stopper.
Signs can be omitted. Treated as + when signs were omitted.

■ASCII→DATE-A

Source		Dest
• ASCII		• DATE-A
0	y	D
1	y	D+1
2	y	D+2
3	y	D+3
4	m	D+4
5	m	D+5
6	d	D+6
7	d	
8	h	
9	h	
10	m	
11	m	
12	s	
13	s	
14	c	
15	c	

For year data, only the last two digits are effective. (The first two digits are ignored.)
cc is not registered to a register.

■ASCII→DATE-Q

Source			Dest	
• ASCII			• DATE-Q	
0	y		D	Year (2000 to xxxx)
1	y		D+1	Month (1 to 12)
2	y		D+2	Date (1 to 31)
3	y		D+3	Hour (0 to 23)
4	m		D+4	Minute (0 to 59)
5	m		D+5	Second (0 to 59)
6	d		D+6	Day of week (0 to 6: Sun to Sat)
7	d			
8	h			
9	h			
10	m			
11	m			
12	s			
13	s			
14	c			
15	c			

cc is not registered to a register.

■ASCII→Float

Source			Dest	
• ASCII			• F4	
	Sign		D	Float type: Bit 0 to Bit 15
	Number 1		D+1	Float type: Bit 16 to Bit 31
	Number 2			
	-			
	Decimal point			
	Number n			
	Number n+1			
	0			
Signs can be omitted. Treated as + when signs were omitted. 0 is the stopper.				
• ASCII			• F8	
	Sign		D	Double type: Bit 0 to Bit 15
	Number 1		D+1	Double type: Bit 16 to Bit 31
	Number 2		D+2	Double type: Bit 32 to Bit 47
	-		D+3	Double type: Bit 48 to Bit 63
	Decimal point			
	Number n			
	Number n+1			
	0			
Signs can be omitted. Treated as + when signs were omitted. 0 is the stopper.				

■ Float → ASCII

Source	Dest																	
<p>• F4</p> <div style="border: 1px solid black; padding: 5px; width: fit-content; margin: 10px auto;">Float type</div>	<p>• ASCII</p> <table border="1" style="margin-bottom: 10px;"> <tr><td>D</td><td>Number 1</td><td>Sign</td></tr> <tr><td>D+1</td><td>Number 3</td><td>Number 2</td></tr> <tr><td>D+2</td><td>Number 5</td><td>Number 4</td></tr> </table> <p style="text-align: center;">-</p> <table border="1" style="margin-bottom: 10px;"> <tr><td>Decimal point</td><td>Number m</td></tr> <tr><td>(Decimal) Number 2</td><td>(Decimal) Number 1</td></tr> <tr><td>(Decimal) Number 4</td><td>(Decimal) Number 3</td></tr> </table> <p style="text-align: center;">-</p> <table border="1" style="margin-bottom: 10px;"> <tr><td>0</td><td>(Decimal) Number n</td></tr> </table> <p>Signs can be omitted. Treated as + when signs were omitted. 0 is the stopper.</p>	D	Number 1	Sign	D+1	Number 3	Number 2	D+2	Number 5	Number 4	Decimal point	Number m	(Decimal) Number 2	(Decimal) Number 1	(Decimal) Number 4	(Decimal) Number 3	0	(Decimal) Number n
D	Number 1	Sign																
D+1	Number 3	Number 2																
D+2	Number 5	Number 4																
Decimal point	Number m																	
(Decimal) Number 2	(Decimal) Number 1																	
(Decimal) Number 4	(Decimal) Number 3																	
0	(Decimal) Number n																	
<p>• F8</p> <div style="border: 1px solid black; padding: 5px; width: fit-content; margin: 10px auto;">Double type</div>	<p>• ASCII</p> <table border="1" style="margin-bottom: 10px;"> <tr><td>D</td><td>Number 1</td><td>Sign</td></tr> <tr><td>D+1</td><td>Number 3</td><td>Number 2</td></tr> <tr><td>D+2</td><td>Number 5</td><td>Number 4</td></tr> </table> <p style="text-align: center;">-</p> <table border="1" style="margin-bottom: 10px;"> <tr><td>Decimal point</td><td>Number m</td></tr> <tr><td>(Decimal) Number 2</td><td>(Decimal) Number 1</td></tr> <tr><td>(Decimal) Number 4</td><td>(Decimal) Number 3</td></tr> </table> <p style="text-align: center;">-</p> <table border="1" style="margin-bottom: 10px;"> <tr><td>0</td><td>(Decimal) Number n</td></tr> </table> <p>Signs can be omitted. Treated as + when signs were omitted. 0 is the stopper.</p>	D	Number 1	Sign	D+1	Number 3	Number 2	D+2	Number 5	Number 4	Decimal point	Number m	(Decimal) Number 2	(Decimal) Number 1	(Decimal) Number 4	(Decimal) Number 3	0	(Decimal) Number n
D	Number 1	Sign																
D+1	Number 3	Number 2																
D+2	Number 5	Number 4																
Decimal point	Number m																	
(Decimal) Number 2	(Decimal) Number 1																	
(Decimal) Number 4	(Decimal) Number 3																	
0	(Decimal) Number n																	

Conversion from programmable controller CPU to SECS/GEM communication software

■ Binary → ASCII

Source	Dest																
<ul style="list-style-type: none"> • I1, I2, U1, or U2 <p>D <table border="1" style="display: inline-table;"><tr><td>I1, U1, I2, or U2</td></tr></table></p>	I1, U1, I2, or U2	<ul style="list-style-type: none"> • ASCII <table border="1" style="display: inline-table;"> <tr><td>0</td><td>Sign</td></tr> <tr><td>1</td><td>Number 1</td></tr> <tr><td>2</td><td>Number 2</td></tr> <tr><td>3</td><td>Number 3</td></tr> <tr><td>-</td><td></td></tr> <tr><td></td><td>Number n</td></tr> <tr><td></td><td>0</td></tr> </table> <p>Signs (+) are omitted.</p>	0	Sign	1	Number 1	2	Number 2	3	Number 3	-			Number n		0	
I1, U1, I2, or U2																	
0	Sign																
1	Number 1																
2	Number 2																
3	Number 3																
-																	
	Number n																
	0																
<ul style="list-style-type: none"> • I4 or U4 <p>D <table border="1" style="display: inline-table;"><tr><td>Low-order word</td></tr></table></p> <p>D+1 <table border="1" style="display: inline-table;"><tr><td>High-order word</td></tr></table></p>	Low-order word	High-order word	<ul style="list-style-type: none"> • ASCII <table border="1" style="display: inline-table;"> <tr><td>0</td><td>Sign</td></tr> <tr><td>1</td><td>Number 1</td></tr> <tr><td>2</td><td>Number 2</td></tr> <tr><td>3</td><td>Number 3</td></tr> <tr><td>-</td><td></td></tr> <tr><td></td><td>Number n</td></tr> <tr><td></td><td>0</td></tr> </table> <p>Signs (+) are omitted.</p>	0	Sign	1	Number 1	2	Number 2	3	Number 3	-			Number n		0
Low-order word																	
High-order word																	
0	Sign																
1	Number 1																
2	Number 2																
3	Number 3																
-																	
	Number n																
	0																

■ ASCII → Binary

Source	Dest													
<ul style="list-style-type: none"> • ASCII <p>D <table border="1" style="display: inline-table;"><tr><td>Ten thousands</td><td>Sign</td></tr></table></p> <p>D+1 <table border="1" style="display: inline-table;"><tr><td>Hundred</td><td>Thousand</td></tr></table></p> <p>D+2 <table border="1" style="display: inline-table;"><tr><td>One</td><td>Ten</td></tr></table></p> <p>D+3 <table border="1" style="display: inline-table;"><tr><td>0</td><td></td></tr></table></p> <p>Fixed format</p>	Ten thousands	Sign	Hundred	Thousand	One	Ten	0		<ul style="list-style-type: none"> • I1, I2, U1, or U2 <p><table border="1" style="display: inline-table;"><tr><td>I1, I2, U1, or U2</td></tr></table></p>	I1, I2, U1, or U2				
Ten thousands	Sign													
Hundred	Thousand													
One	Ten													
0														
I1, I2, U1, or U2														
<ul style="list-style-type: none"> • ASCII <p>D <table border="1" style="display: inline-table;"><tr><td>Billion</td><td>Sign</td></tr></table></p> <p>D+1 <table border="1" style="display: inline-table;"><tr><td>Ten millions</td><td>Hundred millions</td></tr></table></p> <p>D+2 <table border="1" style="display: inline-table;"><tr><td>Hundred thousands</td><td>Million</td></tr></table></p> <p>D+3 <table border="1" style="display: inline-table;"><tr><td>Thousand</td><td>Ten thousands</td></tr></table></p> <p>D+4 <table border="1" style="display: inline-table;"><tr><td>Ten</td><td>Hundred</td></tr></table></p> <p>D+5 <table border="1" style="display: inline-table;"><tr><td>0</td><td>One</td></tr></table></p> <p>Fixed format</p>	Billion	Sign	Ten millions	Hundred millions	Hundred thousands	Million	Thousand	Ten thousands	Ten	Hundred	0	One	<ul style="list-style-type: none"> • I4 or U4 <p><table border="1" style="display: inline-table;"><tr><td>I4 or U4</td></tr></table></p>	I4 or U4
Billion	Sign													
Ten millions	Hundred millions													
Hundred thousands	Million													
Thousand	Ten thousands													
Ten	Hundred													
0	One													
I4 or U4														

A

■DATE-A→ASCII

Source			Dest		
• DATE-A			• ASCII		
D	Year	(0 to 99)	0		y
D+1	Month	(1 to 12)	1		y
D+2	Date	(1 to 31)	2		y
D+3	Hour	(0 to 23)	3		y
D+4	Minute	(0 to 59)	4		m
D+5	Second	(0 to 59)	5		m
D+6	Day of week	(0 to 6: Sunday to Saturday)	6		d
			7		d
			8		h
			9		h
			10		m
			11		m
			12		s
			13		s
			14		c
			15		c

■DATE-Q→ASCII

Source			Dest		
• DATE-Q			• ASCII		
D	Year	(2000 to xxxx)	0		y
D+1	Month	(1 to 12)	1		y
D+2	Date	(1 to 31)	2		y
D+3	Hour	(0 to 23)	3		y
D+4	Minute	(0 to 59)	4		m
D+5	Second	(0 to 59)	5		m
D+6	Day of week	(0 to 6: Sun to Sat)	6		d
			7		d
			8		h
			9		h
			10		m
			11		m
			12		s
			13		s
			14		c
			15		c

■ Float→ASCII

Source	Dest
<p>• F4</p> <p>D Float type: Bit 0 to Bit 15</p> <p>D+1 Float type: Bit 16 to Bit 31</p>	<p>• ASCII</p> <p>Sign</p> <p>Number 1</p> <p>Number 2</p> <p>Number 3</p> <p>-</p> <p>Number m</p> <p>Decimal point</p> <p>(Decimal) Number 1</p> <p>(Decimal) Number 2</p> <p>-</p> <p>(Decimal) Number n</p> <p>0</p>
<p>• F8</p> <p>D Double type: Bit 0 to Bit 15</p> <p>D+1 Double type: Bit 16 to Bit 31</p> <p>D+2 Double type: Bit 32 to Bit 47</p> <p>D+3 Double type: Bit 48 to Bit 63</p>	<p>• ASCII</p> <p>Sign</p> <p>Number 1</p> <p>Number 2</p> <p>Number 3</p> <p>-</p> <p>Number m</p> <p>Decimal point</p> <p>(Decimal) Number 1</p> <p>(Decimal) Number 2</p> <p>-</p> <p>(Decimal) Number n</p> <p>0</p>



Appendix 3 Reserved Transactions

This section shows transactions and message formats used internally by the SECS/GEM communication software.

List of reserved transactions and format

This section shows reserved transactions and message formats.

The names and formats of reserved transactions are reserved and defined by the SECS/GEM communication software and cannot be used for user definitions.

No.	Name	Transaction	Description
1	DTR* ¹ (Date and time request)	Primary message: S2F17(H→E) Secondary message: S2F18(H←E)	Sends clock data of the SECS/GEM communication software pre-installed model module. The programmable controller CPU is not notified.
2	RSD* ¹ (Spooled data request)	Primary message: S6F23(H→E) Secondary message: S6F24(H←E)	Requests the spooled data transfer from the host.
3	CA_ARS* ¹ (Alarm report transmission)	Primary message: S5F1(H←E) Secondary message: S5F2(H→E)	Used by the CA-SECS alarm function.
4	H_SCABT (Host scenario interruption request)	Primary message: S99F1(H→E) Secondary message: Unused	Interrupts the ongoing scenario from the host.
5	E_SCABT (Equipment scenario interruption notification)	Primary message: S99F3(H←E) Secondary message: Unused	Notifies that the ongoing scenario was interrupted by equipment request or processing error.

*1 Reserved transaction of non-GEM version.

1. DTR (Date and time request)	
<pre><S2F17>(H→E) (Header only) <S2F18>(H←E) A<TIME>YYYYMMDDhhmmsscc</pre>	<p>Acquires the time configured to the CPU of the SECS/GEM communication software pre-installed model module, and then returns it as 16-byte ASCII data.</p> <p>This transaction does not involve notification to the Programmable Controller CPU or acquisition of the equipment time data.</p>
2. RSD (Spooled data request)	
<pre><S6F23>(H→E) U1<RSDC>...(1) <S6F24>(H←E) B<RSDA>...(2)</pre>	<p>(1) The following code will apply.</p> <p>0: Transfer the spooled message(s)</p> <p>1: Discard the spooled messages(s)</p> <p>(2) One of the following values is returned.</p> <p>0: OK (initiate the spool output)</p> <p>1: Error</p> <p>2: No spooled data exists.</p> <ul style="list-style-type: none"> If communication has been established, this transaction can be executed even before CA-SECS becomes online (i.e., before the transaction S1F1 is executed). The reception of this message will not be notified to the Programmable Controller CPU.
3. CA_ARS (Alarm report transmission)	
<pre><S5F1>(H←E) <L, 3> B<ALCD>...(1) U2<ALID>...(2) A<ALTX>...(3) <S5F2>(H→E) B<ACKC5></pre>	<p>(1) The settings in the Alarm Data Setting window are edited as follows and then transmitted.</p> <p>When an alarm occurs: The first bit is "1".</p> <p>When an alarm is reset: The first bit is "0".</p> <p>(2) The set value is transmitted as it is.</p> <p>(3) The set text is transmitted as it is.</p> <p>Up to 40 characters can be transmitted.</p> <ul style="list-style-type: none"> Response monitoring is enabled in accordance with the standard for SECS-II. However, the reception notification of a secondary message will not be reported to the programmable controller CPU. To send an alarm report as a normal transaction triggered by the sending request, set the user definition by another transaction name.
4. H_SCABT (Host scenario interruption request)	
<pre><S99F1>(H→E) (Header only)</pre>	<p>This transaction is transmitted from the host to interrupt the ongoing scenario.</p>
5. E_SCABT (Equipment scenario interruption notification)	
<pre><S99F3>(H←E) (Header only)</pre>	<p>When the ongoing scenario was interrupted by any other than the host scenario interruption request, this transaction is transmitted to the host.</p>

Special Transactions

This section shows special transactions and message formats.

The special transactions shown below are user definable transactions but are specially processed by the SECS/GEM communication software internally at the same time as a notification to the programmable controller CPU.

No.	Name	Transaction	Description
1	R (Online request)	Primary message: S1F1(H↔E) Secondary message: S1F2(H↔E)	Establishes the SECS/GEM communication software online status when this transaction is completed
2	CR (Communication request)	Primary message: S1F13(H↔E) Secondary message: S1F14(H↔E)	Where line disconnection is not considered as offline, this transaction will be automatically transmitted when the line is reconnected.
3	DTR_2 (Date and time request)	Primary message: S2F17(H←E) Secondary message: S2F18(H→E)	Configures the time data returned from the host to the clock of the SECS/GEM communication software pre-installed model module.
4	DTS (Date and time setting)	Primary message: S2F31(H→E) Secondary message: S2F32(H←E)	Configures clock data of the SECS/GEM communication software pre-installed model module.

1. R (Online request)	
<pre><S1F1>(H↔E) (Header only) <S1F2>(H↔E) <L, 2> A<MDLN> A<SOFTREV></pre>	<p>SECS/GEM communication software becomes online when this transaction is completed.</p> <p>Online status established based on this transaction is determined from the SF code.</p> <p>Even if this transaction has a different name or format from that shown in the left, the same processing will be performed.</p>

2. CR (Communication request)	
<pre><S1F13>(H↔E) <L, 2> A<MDLN> A<SOFTREV> <S1F14>(H↔E) <L, 2> B<COMMACK> <L, 2> A<MDLN> A<SOFTREV></pre>	<p>When the "Automatically Transmit S1F13 Upon Line Reconnection" is enabled in the Option Setting window, this transaction is transmitted automatically to the host when the line is reconnected.</p> <p>If the transaction is undefined, automatic transmission will not be performed.</p> <p>Online status established based on this transaction is determined from the SF code. Even if this transaction has a different name or format from that shown in the left, the same processing will be performed.</p> <ul style="list-style-type: none"> Setting the parent list of MDLN and SOFTREV to a variable length list makes it possible for the host to transmit this as <L, 0>. When handshake for each transaction is enabled, note that the reception of secondary messages at the time of automatic transmission will no longer be notified to the Programmable Controller CPU.

3. DTR_2 (Date and time request)	
<pre><S2F17>(H←E) (Header only) <S2F18>(H→E) A<TIME>YYYYMMDDhhmmsscc*1</pre>	<p>In the case of a MELSEC-Q series SECS/GEM communication software pre-installed model module, the time received by <TIME> is configured to the clock of the SECS/GEM communication software pre-installed model module. However, because the time zone of CPU No. 1 is followed by a multi-CPU system, configure the time of CPU No. 1 by the programmable controller CPU. Notification to the programmable controller CPU is performed according to the setting.</p> <p>This differs with a DTS transaction in that the time of the host is acquired by a request on the programmable controller CPU.</p> <p>The transaction name "DTR" is not available since it is already used for a reserved transaction.</p> <p>When any other name is given, the sequence above will be executed and the reserved transaction "DTR" will be invalid. (The reserved transaction "DTR" is a time request from the host).</p>

*1 When data count in <TIME> is set to 16 and variable length setting is enabled, it supports the reception of the following three formats:
 16 byte format (YYYYMMDDhhmmsscc)
 14 byte format (YYYYMMDDhhmmss)
 12 byte format (YYMMDDhhmmss)



4. DTS (Date and time setting)

<S2F31>(H→E)

A<TIME>YYYYMMDDhhmmsscc*1

<S2F32>(H←E)

B<TIACK>

In the case of a MELSEC-Q series SECS/GEM communication software pre-installed model module, the time configured by <TIME> is configured to the clock of the SECS/GEM communication software pre-installed model module. However, because the time zone of CPU No. 1 is followed by a multi-CPU system, configure the time of CPU No. 1 by the programmable controller CPU. Notification to the programmable controller CPU is performed according to the setting.

The online status setting of the C Controller module with this transaction is based on the SF code. Even if the transaction name differs from the name on the left, the processing will be the same.

*1 When data count in <TIME> is set to 16 and variable length setting is enabled, it supports the reception of the following three formats:

16 byte format (YYYYMMDDhhmmsscc)

14 byte format (YYYYMMDDhhmmss)

12 byte format (YYMMDDhhmmss)

System Error (S9Fx)

The SECS/GEM communication software provides the following error messages.

No.	Name	Transaction	Description
1	UDN (Incorrect device ID)	S9F1(H←E)	Notifies that the device ID in the header of the received message is different from the device ID set in SECS/GEM communication software.
2	USN (Unrecognized Stream Type)	S9F3(H←E)	The Stream code of a received message notifies of a lack of the definition at the SECS/GEM communication software.
3	UFN (Unrecognized Function Type)	S9F5(H←E)	The Function code of a received message notifies of a lack of the definition at the SECS/GEM communication software.
4	IDN (Illegal Data)	S9F7(H←E)	Notifies that the format of the received message from the host is different from the message format set in SECS/GEM communication software.
5	TTN (Transaction time-out)	S9F9(H←E)	Notifies that T3 timer (host response monitoring timer) time-out occurred.
6	DLN (Data Too Long)	S9F11(H←E)	Notifies that CA-SECS received an improperly sized message that cannot be processed by SECS/GEM communication software.

1. Incorrect device ID, 2. Unrecognized Stream Type, 3. Unrecognized Function Type, 4. Illegal Data, 6. Data Too Long

Example: S9F1

<S9F1>(H←E)

B10<MHEAD>

<S9F2>

(Unused)

The header of the received message (erroneous message) is configured to <MHEAD>.

5. Transaction time-out

S9F9

<S9F9>(H←E)

B10<SHEAD>

<S9F10>

(Unused)

The header of the sending message (primary) in the timed-out transaction is configured to <SHEAD>.

S9F13. CTN (Conversation Timeout)

S9F13

<S9F13>(H←E)

<L, 2>

A<MEXP>

-<EDID>

<S9F14>

(Unused)

User definition of S9F13 is necessary.

Appendix 4 SECS item list

This section is a list of items the SECS/GEM communication software uses with GEM scenarios.

Item name	Description	Item format		
		Supported data type	Supported data size (Byte)	Changeability
ACKC5	Confirmation code	BIN	1	×
ACKC6	Confirmation code	BIN	1	×
ACKC7	Confirmation code	BIN	1	×
ALCD	Alarm code	BIN	1	○
ALED	Alarm on/off code	BIN	1	○
ALID	Alarm ID	U1, U2, U4	1	○
ALTX	Alarm text	ASCII	Maximum of 40	○
CEED	Collected events or trace on/off code	BOOL	1	○
CEID	Acquired event ID	U1, U2, U4	1	○
COMMACK	Communication establishment confirmation code	BIN	1	×
DATAID	Data ID	U1, U2, U4	1	○
DATALENGTH	Total number of sending data bytes	U1, U2, U4	1	○
DRACK	Definition report agreement code	BIN	1	×
DSPER	Data acquisition time	ASCII	6, 8	○
EAC	Equipment confirmation code	BIN	1	×
ECDEF	Equipment variable default value	—	—	×
ECID	Equipment constant ID	U1, U2, U4	1	○
ECMAX	Equipment variable maximum value	—	—	×
ECMIN	Equipment variable minimum value	—	—	×
ECNAME	Equipment constant name	ASCII	Maximum of 32	○
ECV	Device constant	BIN, BOOL, ASCII, JIS8, I1, I2, I4, U1, U2, U4, F4, F8	Maximum of 32,000 for BIN, ASCII, and JIS8 Otherwise, 1	○
EDID	Date ID that should be received	U1, U2, U4	1	×
ERACK	Enable/disable event report confirmation code	BIN	1	×
FCNID	Function identification	U1	1	○
GRANT	Permission code	BIN	1	×
GRANT6	Sending permission	BIN	1	×
LIMITACK	Confirmation code for variable limit attribute setting	BIN	1	×
LIMITID	Specific limit for a variable referenced by a corresponding limit attribute	BIN	1	○
LIMITMAX	Maximum permitted value for limit value of specific variable	—	—	×
LIMITMIN	Minimum permitted value for limit value of specific variable	—	—	×
LOWERDB	Dead band lower limit	—	—	×
LRACK	Link report confirmation code	BIN	1	×
LVACK	Response code for variable limit attribute setting	BIN	1	×
MDLN	Equipment form	ASCII	Maximum of 20	○
MEXP	Message SxxFyy that should be received	ASCII	Minimum of 2, maximum of 6	○
OFLACK	Confirmation code for offline request	BIN	1	×
ONLACK	Confirmation code for online request	BIN	1	×
PPID	Process program ID	ASCII	Maximum of 80	○
REPGSZ	Report group size	U1, U2, U4	1	○
RPTID	Report ID	U1, U2, U4	1	○



Item name	Description	Item format		
		Supported data type	Supported data size (Byte)	Changeability
RSDA	Spoiled data request confirmation	BIN	1	×
RSDC	Spoiled data request code	U1	1	○
RSPACK	Spoiled data setting confirmation	BIN	1	×
SMPLN	Sample number	U1, U2, U4	1	○
SOFTREV	Revision code of software	ASCII	Maximum of 20	○
STIME	Sample time	ASCII	12, 16	○
STRACK	Spool stream response	BIN	1	×
STRID	Stream identification	U1	1	○
SV	State variable data	LIST, BIN, BOOL, ASCII, JIS8, I1, I2, I4, U1, U2, U4, F4, F8	Maximum of 32,000 for BIN, ASCII, and JIS8 Otherwise, 1	○
SVID	State variable ID	U1, U2, U4	1	○
SVNAME	State variable name	ASCII	Maximum of 32	○
TIAACK	Equipment response code	BIN	1	×
TIACK	Time confirmation code	BIN	1	×
TIME	Date and time	ASCII	12, 16	○
TOTSMP	Total sample count	U1, U2, U4	1	○
TRID	Trace request ID	U1, U2, U4	1	○
UNITS	Item to identify unit	ASCII	Maximum of 16	○
UPPERDB	Dead band upper limit	—	—	×
V	Variable data	—	—	×
VID	Variable ID	U1, U2, U4	1	○
VLAACK	Limit attribute confirmation code	BIN	1	×

Appendix 5 Communication Specifications Check Sheet

The check sheet shows what to check in definition of SECS communication. The check sheet is useful for checking the specifications.

Setting item	Setting	Notes
Communication port	SECS-I/HSMS	—
Device ID		—
SECS-I setting		—
Mode	Master / Slave	—
Transmission speed [bps]		—
T1 [sec] (0.1 to 10)		Inter-character time-out
T2 [sec] (0.2 to 25)		Protocol time-out
T3 [sec] (1 to 120)		Response time-out
T4 [sec] (1 to 120)		Inter-block time-out
HSMS setting		—
Host IP address		—
Own station IP address		—
Host port number		—
Own station port number		—
Mode	Passive / Active	—
T3 [sec] (1 to 120)		Response time-out
T5 [sec] (1 to 240)		Connection separation time-out
T6 [sec] (1 to 240)		Control transaction time-out
T7 [sec] (1 to 240)		Not Selected time-out
T8 [sec] (1 to 120)		Inter-character time-out for network
Link Test timer [sec] (1 to 65535)		—
Number of retries after line disconnection (Endless retries / specified number of times)	Endless / times	—
Line disconnection from own station	Enable / Disable	—
Sending-side interleaving (multi-open transaction)	Enable / Disable	Number of multi-transaction queues for PLC transmission
Interleaving for reception (open multi-transactions)	Enable / Disable	Number of multi-transaction queues for PLC reception
Variable length lists	Enable / Disable	—
Variable length items	Enable / Disable	Set the maximum value for the number of data sets.
Switch into offline status upon disconnection	Enable / Disable	—
Spooling	Enable / Disable	—
Multi-block transmission permission by host	Enable / Disable	If Enable is set, a scenario for permission frame must be defined.
SxF0 transmission	Enable / Disable	—
SxF0 reception	Enable / Disable	—
S9F1/F3/F5/F9/F11 transmission	Automatic transmission	—
S9F7(item data error) transmission	Enable / Disable	A scenario for illogical data processing must be defined.
S9F13 transmission	Enable / Disable	If Enable is set, a scenario must be defined for this purpose.
SECS communication log storage	Enable / Disable	—

Appendix 6 SEMI E30(GEM) Support Message

This section shows a list of SEMI E30(GEM) compliant messages.

Stream1 Equipment Status

⊙: Defined, ○: Definition required

Message	Sender	Name	Support
S1F0	H↔E	Abort Transaction (S1F0)	⊙
S1F1	H↔E	Are You There Request (R)	⊙
S1F2	H↔E	On Line Data (D)	⊙
S1F3	H→E	Selected Equipment Status Request (SSR)	⊙
S1F4	H←E	Selected Equipment Status Data (SSD)	⊙
S1F5	H→E	Formatted Status Request (FSR)	○
S1F6	H←E	Formatted Status Data (FSD)	○
S1F11	H→E	Status Variable Namelist Request (SVNR)	⊙
S1F12	H←E	Status Variable Namelist Reply (SVNRR)	⊙
S1F13	H↔E	Establish Communication Request (CR)	⊙
S1F14	H↔E	Establish Communication Request Acknowledge (CRA)	⊙
S1F15	H→E	Request OFF-LINE (ROFL)	⊙
S1F16	H←E	OFF-LINE Acknowledge (OFLA)	⊙
S1F17	H→E	Request ON-LINE (RONL)	⊙
S1F18	H←E	ON-LINE Acknowledge (ONLA)	⊙

Stream2 Equipment Control and Diagnostics

⊙: Defined, ○: Definition required

Message	Sender	Name	Support
S2F0	H↔E	Abort Transaction (S2F0)	⊙
S2F13	H→E	Equipment Constant Request (ECR)	⊙
S2F14	H←E	Equipment Constant Data (ECD)	⊙
S2F15	H→E	New Equipment Constant Send (ECS)	⊙
S2F16	H←E	New Equipment Constant Acknowledge (ECA)	⊙
S2F17	H↔E	Date and Time Request (DTR)	⊙
S2F18	H↔E	Date and Time Data (DTD)	⊙
S2F21	H→E	Remote Command Send (RCS)	○
S2F22	H←E	Remote Command Acknowledge (RCA)	○
S2F23	H→E	Trace Initialize Send (TIS)	⊙*1
S2F24	H←E	Trace Initialize Acknowledge (TIA)	⊙*1
S2F25	H↔E	Loopback Diagnostic Request (LDR)	○
S2F26	H↔E	Loopback Diagnostic Data (LDD)	○
S2F29	H→E	Equipment Constant Namelist Request (ECNR)	⊙
S2F30	H←E	Equipment Constant Namelist (ECN)	⊙
S2F31	H→E	Date and Time Set Request (DTR)	⊙
S2F32	H←E	Date and Time Set Acknowledge (DTA)	⊙
S2F33	H→E	Define Report (DR)	⊙
S2F34	H←E	Define Report Acknowledge (DRA)	⊙
S2F35	H→E	Link Event Report (LER)	⊙
S2F36	H←E	Link Event Report Acknowledge (LERA)	⊙
S2F37	H→E	Enable/Disable Event Report (EDER)	⊙
S2F38	H←E	Enable/Disable Event Report Acknowledge (EERA)	⊙
S2F39	H→E	Multi-block Inquire(DMBI)	⊙
S2F40	H←E	Multi-Block Grant (MBG)	⊙

Message	Sender	Name	Support
S2F41	H→E	Host Command Send (HCS)	○
S2F42	H←E	Host Command Acknowledge (HCA)	○
S2F43	H→E	Reset Spooling Stream and Function (RSSF)	◎
S2F44	H←E	Reset Spooling Acknowledge (RSA)	◎
S2F45	H→E	Define Variable Limit Attributes (DVLA)	◎*1
S2F46	H←E	Variable Limit Attribute Acknowledge (VLAA)	◎*1
S2F47	H→E	Variable Limit Attributes Request (VLAR)	◎*1
S2F48	H←E	Variable Limit Attributes Send (VLAS)	◎*1
S2F49	H→E	Enhanced Remote Command	○
S2F50	H←E	Enhanced Remote Command Acknowledge	○

*1 A GEM version requires a definition.

Stream5 Exception Handling

◎: Defined, ○: Definition required

Message	Sender	Name	Support
S5F0	H↔E	Abort Transaction (S5F0)	◎
S5F1	H←E	Alarm Report Send (ARS)	◎
S5F2	H→E	Alarm Report Acknowledge (ARA)	◎
S5F3	H→E	Enable/Disable Alarm Send (EAS)	◎
S5F4	H←E	Enable/Disable Alarm Acknowledge (EAA)	◎
S5F5	H→E	List Alarm Request (LAR)	◎
S5F6	H←E	List Alarm Data (LAD)	◎
S5F7	H→E	List Enabled Alarm Request (LEAR)	◎*1
S5F8	H←E	List Enabled Alarm Data (LEAD)	◎*1

*1 A MELSEC iQ-R series requires a definition.

Stream6 Data Collection

◎: Defined, ○: Definition required

Message	Sender	Name	Support
S6F0	H↔E	Abort Transaction (S6F0)	◎
S6F1	H←E	Trace Data Send (TDS)	◎
S6F2	H→E	Trace Data Acknowledge (TDA)	◎
S6F5	H←E	Multi-Block Data Send Inquire (MBI)	◎
S6F6	H→E	Multi-Block Grant (MBG)	◎
S6F11	H←E	Event Report Send (ERS)	◎
S6F12	H→E	Event Report Acknowledge (ERA)	◎
S6F15	H→E	Event Report Request (ERR)	◎
S6F16	H←E	Event Report Data (ERD)	◎
S6F19	H→E	Individual Report Request (IRR)	◎
S6F20	H←E	Individual Report Data (IRD)	◎
S6F23	H→E	Request Spooled Data (RSD)	◎
S6F24	H←E	Request Spooled Data Acknowledgment Send (RSDAS)	◎

Stream7 Process Program Management

◎: Defined, ○: Definition required

Message	Sender	Name	Support
S7F0	H↔E	Abort Transaction (S7F0)	◎
S7F1	H↔E	Process Program Load Inquire (PPI)	○

Message	Sender	Name	Support
S7F2	H↔E	Process Program Load Grant (PPG)	○
S7F3	H↔E	Process Program Send (PPS)	○
S7F4	H↔E	Process Program Acknowledge (PPA)	○
S7F5	H↔E	Process Program Request (PPR)	○
S7F6	H↔E	Process Program Data (PPD)	○
S7F7	H←E	Process Program ID Request (PIR)	○
S7F8	H→E	Process Program ID Data (PID)	○
S7F17	H→E	Delete Process Program Send (DPS)	◎*1
S7F18	H←E	Delete Process Program Acknowledge (DPA)	◎*1
S7F19	H→E	Current EPPD Request (RER)	◎*1
S7F20	H←E	Current EPPD Data (RED)	◎*1
S7F23	H↔E	Formatted Process Program Send (FPS)	○
S7F24	H↔E	Formatted Process Program Acknowledge (FPA)	○
S7F25	H↔E	Formatted Process Program Request (FPR)	○
S7F26	H↔E	Formatted Process Program Data (FPD)	○
S7F27	H←E	Process Program Verification Send (PVS)	○
S7F28	H→E	Process Program Verification Acknowledge (PVA)	○

*1 A GEM version requires a definition.

Stream9 System Errors

◎: Defined, ○: Definition required

Message	Sender	Name	Support
S9F0	H↔E	Abort Transaction (S9F0)	◎
S9F1	H←E	Unrecognized Device ID (UDN)	◎
S9F3	H←E	Unrecognized Stream Type (USN)	◎
S9F5	H←E	Unrecognized Function Type (UFN)	◎
S9F7	H←E	Illegal Data (IDN)	◎
S9F9	H←E	Transaction Timer Timeout (TTN)	◎
S9F11	H←E	Data Too Long (DLN)	◎
S9F13	H←E	Conversation Timeout (CTN)	◎

Stream10 Terminal Services

◎: Defined, ○: Definition required

Message	Sender	Name	Support
S10F0	H↔E	Abort Transaction (S10F0)	◎
S10F1	H←E	Terminal Request (TRN)	○
S10F2	H→E	Terminal Request Acknowledge (TRA)	○
S10F3	H→E	Terminal Display, Single (VTN)	○
S10F4	H←E	Terminal Display, Single Acknowledge (VTA)	○
S10F5	H→E	Terminal Display, Multi-block (VTN)	○
S10F6	H←E	Terminal Display, Multi-BlockAcknowledge (VMA)	○
S10F7	H←E	Multi-block Not Allowed(MNN)	○

Appendix 7 SECS/GEM communication software unique ACK code list

This section shows the list of ACK codes.

Name	Item Format Code	Description	Value		Application
			E5-1107	SECS/GEM communication software inherent	
ACKC5	10	Confirmation code, 1 byte	0 = Agreement >0 = Error, cannot be comprehended 1 to 63: reserved	1 = ALID does not exist	S5F2, F4
DRACK	10	Definition report agreement code, 1 byte	0 = Agreement 1 = Denied, space insufficient 2 = Denied, disabled format 3 = Denied, at least one RPTID is already defined. 4 = Denied, not even one VID exists. >4 = Other error 5 to 63: reserved	5 = RPTID value incorrect (RPTID=0) 6 = Excessive linkable VID for one RPTID	S2F34
EAC	10	Equipment confirmation code, 1 byte	0 = Agreement 1 = Denied, not even one variable exists. 2 = Denied, busy 3 = Denied, at least one variable is outside the range >3 = Other equipment inherent error 4 to 63: reserved	4 = Batch conversion ECV value exceeded 5 = Variable cannot be changed 6 = System error (register writing)	S2F16
LIMITACK	10	Confirmation code for variable limit attribute setting, 1 byte	1 = LIMITID does not exist. 2=UPPERDB > LIMITMAX 3=LOWERDB < LIMITMIN 4=UPPERDB < LOWERDB 5 = Clearly incorrect format for UPPERDB or LOWERDB 6 = Cannot be interpreted as a numerical value because it is an ASCII value 7 = Limit definitions overlap for this variable >7 = Other equipment specific error 8 to 63: reserved	8 = Limit definition cannot be registered	S2F46
LRACK	10	Link report confirmation code, 1 byte	0 = Agreement 1 = Denied, space insufficient 2 = Denied, disabled format 3 = Denied, at least one CEID link is already defined. 4 = Denied, not even one CEID exists. 5 = Denied, not even one RPTID exists. >5 = Other error 6 to 63: reserved	6 = Excessive linkable RPTID for one CEID	S2F36
TIAACK	10	Equipment response code, 1 byte	0 = Normal 1 = Too many state variable IDs (SVID) 2 = Trace not possible after this 3 = Invalid trace interval >3 = Machine inherent error 4 to 63: reserved	4 = SV not registered 5 = SV incorrect format 6 = TRID value incorrect (TRID=0) 7 = Excessive reportable sample number at one time	S2F24



Appendix 8 Added and Changed Functions

The following section shows the functions added or changed for the SECS/GEM communication software, and the software versions of the SECS/GEM communication software for these functions.

Added/changed contents	Software version of SECS/GEM communication software						Reference
	MELSEC-Q series			MELSEC iQ-R series			
	Non-GEM version	GEM version	GEM advanced version	Non-GEM version	GEM version	GEM advanced version	
Device find/replace function	Ver.1.26C	Ver.1.26C	Ver.1.26C	Ver.1.26C	Ver.1.26C	Ver.1.26C	Page 130 Device Find/Replace
Display setting for logs View the Log on Display Device (GOT)	Ver.1.01B	Ver.1.26C	Ver.1.26C	Ver.1.26C	Ver.1.26C	Ver.1.26C	Page 140 Display Setting Page 149 View the Log on Display Device (GOT)
Extending the ranges of devices that can be used for I/O assignment	—	—	—	Ver.1.28E	—	—	Page 68 Available device ranges
Extending the number of units of data in an item information definition	—	—	—	Ver.1.28E	—	—	Page 57 Data types (item format codes)
Extending the ranges of devices that can be found/replaced	—	—	—	Ver.1.28E	—	—	Page 130 Device Find/Replace

REVISIONS

*The manual number is given on the bottom left of the back cover.

Revision date	*Manual number	Description
January 2020	BCN-89999-6494-A	First edition
February 2020	BCN-89999-6494-B	■Added or modified parts Section 9.8, Appendix 4, Appendix 6

Japanese manual number: BCN-89999-6493-B

This manual confers no industrial property rights of any other kind, nor does it confer any patent licenses. Mitsubishi Electric Corporation cannot be held responsible for any problems involving industrial property rights which may occur as a result of using the contents noted in this manual.

© 2020 MITSUBISHI ELECTRIC CORPORATION

TRADEMARKS

The company names, system names and product names mentioned in this manual are either registered trademarks or trademarks of their respective companies.

In some cases, trademark symbols such as [™] or [®] are not specified in this manual.

BCN-89999-6494-B(2002)

mitsubishi electric corporation

HEAD OFFICE : TOKYO BUILDING, 2-7-3 MARUNOUCHI, CHIYODA-KU, TOKYO 100-8310, JAPAN
NAGOYA WORKS : 1-14, YADA-MINAMI 5-CHOME, HIGASHI-KU, NAGOYA, JAPAN

When exported from Japan, this manual does not require application to the
Ministry of Economy, Trade and Industry for service transaction permission.

Specifications subject to change without notice.